

*Treatise on ammunition.*  
*Eds. 1,2,4 [2 eds.], 5-8*

War office

75  
G. No.  
992

# TREATISE

ON

# AMMUNITION.

---

---

*Printed by Order of the Secretary of State for War.*

---

---



LONDON:

*Printed under the Superintendence of Her Majesty's Stationery Office,*

AND SOLD BY

W. CLOWES & SONS, 13, Charing Cross; HARRISON & SONS, 59, Pall Mall;  
W. H. ALLEN & Co., 13, Waterloo Place; W. MITCHELL, 39, Charing Cross;  
LONGMAN & Co., Paternoster Row; TRÜBNER & Co., 57 & 59, Ludgate Hill;  
STANFORD, Charing Cross; and HENRY S. KING & Co., 65 Cornhill;

ALSO BY

GRIFFIN & Co., The Hard, Portsea;  
A. AND C. BLACK, Edinburgh; D. ROBERTSON, 90, St. Vincent Street, Glasgow;  
ALEX. THOM, Abbey-street, and E. PONSONBY, Grafton-street, Dublin.

1874.

*Price Six Shillings.*

731 / 31





# INTRODUCTION.

---

## ERRATUM.

---

Copies of "AMMUNITION, PART I.," may still be obtained, a second thousand having been published by

W. MITCHELL, 39, CHARING CROSS,

and **NOT** by

Messrs. LONGMAN, as stated.

34983.

~~was never published up to date.~~

Frequent reference has also been made to Extracts from the proceedings of the Department of the Director of Artillery. The Extracts are published quarterly, and may also be obtained from the R. A. Institution. Brief accounts of the various experiments carried on will be found in them. They are useful as a guide to

---

\* Some copies of Ammunition, Part I., may still be obtained, a second thousand having been published by Messrs. Longman. The official edition is exhausted.

38683.

n 2





## INTRODUCTION.

---

It has become necessary to publish a new work on Ammunition, Parts I. and II. of Ammunition by Captains Majendie and Browne being out of print.\* Smooth bore ordnance is rapidly being discarded, therefore it is unnecessary to treat the subject at length. Part I. included not only S. B. Ordnance, but many articles of Ammunition used in conjunction with rifled ordnance. In order to make a complete work, selections have been made from Parts I. and II., omitting such portions as have ceased to be of importance owing to changes in materiel, and making the additions necessary to bring the work up to date.

The book has been arranged so as to embrace in the opening chapters the Ammunition common to the various systems of S. B. and rifled guns. Each system has then been treated separately; the concluding chapters contain B. L. Small arm Ammunition and Rockets.

Fuzes have been treated as a whole, some fuzes being common to both rifled and S. B. guns, and in all cases the similarity is so great that it is convenient to keep them together.

The statements in the text have, as far as possible, been supported by references to Changes in War stores, where extended information will frequently be found.

The Changes are published monthly, Artillery Officers can obtain them through the R.A. Institution, and by means of them can keep this book up to date.

Frequent reference has also been made to Extracts from the proceedings of the Department of the Director of Artillery. The Extracts are published quarterly, and may also be obtained from the R. A. Institution. Brief accounts of the various experiments carried on will be found in them. They are useful as a guide to

---

\* Some copies of Ammunition, Part I., may still be obtained, a second thousand having been published by Messrs. Longman. The official edition is exhausted.

the value of the new materiel which is at present being rapidly introduced into the service.

Many pages have been taken verbatim from *Ammunition*, Parts I. and II., by Captains Majendie and Browne, the greater parts of Chapters XI., XII., and XVI. have been reprinted from Part II. The value of the works above mentioned is well known, and I can hardly hope to equal them in accuracy.

As far as possible detailed information has been given in the form of tables, in order not to encumber the text with a mass of figures useful only for reference.

The proportion of *Ammunition* issued in connection with ordnance, will be found in Revised Army Regulations, Vol. III., 1870. Some important changes have been made, which have been notified from time to time in Army Circulars.

In demanding stores the nomenclature of the priced Vocabulary of Stores should be adhered to, this nomenclature has been followed in the index.

Some important circulars relating to Magazines, Gunpowder, and Laboratory operations are given in the Appendix.

I have received much assistance from Sergeant-Major Macken and Sergeant-Instructors Dickson and Tims in preparing this work for the press.

W. R. BARLOW,  
Major, R.A.

Captain Instructor, Royal Laboratory.

*July* 1874.

## LIST OF ABBREVIATIONS.

---

F.G.	Fine Grain.
R.F.G.	Rifle Fine Grain.
L.G.	Large Grain.
R.L.G.	Rifle Large Grain.
P.	Pebble.
L.S.	Land Service.
S.S.	Sea Service.
G.S.	General Service.
F.S.	Field Service.
R.L.	Royal Laboratory.
R.G.F.	Royal Gun Factory.
S.B.	Smooth Bore.
M.L.	Muzzle Loading.
B.L.	Breech Loading.
M.L.O.	Muzzle Loading Ordnance.
R.M.L.O.	Rifled Muzzle Loading Ordnance.
R.B.L.O.	Rifled Breech Loading Ordnance.
S.A.	Small Arms.
R.A.	Royal Artillery.
§	Paragraph of Changes in War Stores.
A.C.	Army Circular.
EXTRACTS.	Extracts from the Proceedings of the Department of the Director of Artillery.
O.S.C.	Ordnance Select Committee.

NOTE.—Stores which are issued for practice only are to be marked 914. with a yellow line. A blue line is painted on obsolete stores in the Royal Laboratory, while red is often used to indicate powder. The colour red is generally used as an indication of danger; thus, a red flag is used at rifle ranges, powder barges, &c. are painted red, and filled shells are marked with red letters.

---





## CHAPTER I.—GUNPOWDER.

---

THE PROPERTIES OF ALL POWDERS USED IN THE SERVICE.—USE OF EACH KIND.—LIABILITY OF GUNPOWDER TO EXPLODE FROM A BLOW, OR FROM FRICTION.

---

The manufacture of gunpowder will be found fully given in the *Handbook on the Manufacture and Proof of Gunpowder* by Captain F. M. Smith, R.A. It is necessary to give a short account of some of the leading properties of gunpowder which bear directly on its employment for different natures of cartridges, and for other Laboratory uses. Properties of Gunpowder.

The composition has remained unaltered for many years, having in 100 parts, 75 of saltpetre, 15 of charcoal, and 10 of sulphur. Its exploding point is about 600° F.; but gunpowder will deteriorate at much lower temperatures, it begins to lose sulphur at 212°, this ingredient passing off rapidly as the temperature rises.\*

The qualities which most influence gunpowder with regard to its use in rifled guns, are its density, size and shape of grain, and the condition of the charcoal. It is essential that powder for rifled guns should be uniform in action, to ensure regularity in range, otherwise the accuracy of the guns will be impaired.

The denser gunpowder is, the slower it will burn, as the dense powder will offer a smaller surface to ignition than an equal weight of a less compact kind; for a similar reason, a large grain will burn slower than a number of small grains making up the same weight, and a grain of regular shape, such as a cube, or a sphere, will offer less surface than an irregular one of the same mass; a laminated or flakey form is well known to indicate a violent powder. Much will depend on the degree to which the burning of the charcoal is carried, as, if it is imperfectly charred, the oxygen and hydrogen retained in it, cause it to burn much more rapidly than when it is reduced to nearly a pure carbon.†

---

\* Bloxam's Chemistry, p. 422.

† The violence of some Madras powder was attributed by the Committee on Explosives (Report, 1872, p. 50) to the low density, flakey form of grain, and quality of charcoal.

There are other minor points influencing the rate of burning which need not be considered in this place.

We may say then, that a large grained, dense powder will burn slower than a small grained powder of low density; always supposing that the grain is sufficiently large to leave interstices for the passage of the flash, as otherwise, the charge of powder would only be ignited at one place, and would therefore burn slowly, this would, however, only take place when the powder is reduced to an impalpable dust.

On the introduction of rifled guns it was considered advisable to use a powder which would burn more gradually, and strain the gun less than the powder then in use for S.B. guns. More work is thrown on rifled guns, as not only a forward velocity, but also a velocity of rotation must be given to the projectile; the weight too of the projectile is much greater in a rifled gun than in a S.B. gun of the same calibre; thus an 8-inch rifled gun throws a projectile of 180 lbs. weight, a S.B. gun, one of 68 lbs. weight.

To attain this end, the density and size of grain has been increased, "R.L.G." being introduced for rifled guns. This powder answered very well for guns of small calibre; but when "R.M.L." guns of 7 inch and upwards were introduced, burning large quantities of powder, it was found advisable to use a slower burning powder than "R.L.G." Hence "P" powder was introduced, a powder of high density and very large grain. It burns more slowly than "R.L.G." and consequently strains the gun less.

A very large stock of "L.G." powder still remains on hand; in order to utilize it, "L.G." is now largely used with rifled guns, except the 7-pr.; this is, however, only a temporary measure, as no more "L.G." powder will be made.\*

For small arms a rapidly burning powder is required, therefore a much smaller grain is used. There are four kinds, "F.G." for smooth bore small arms, "R.F.G." and "R.F.G.<sup>2</sup>" for rifled small arms, and "pistol" powder. "F.G." is used for the charges of the 7-pr. R.M.L. gun, as owing to the shortness of the bore, a quick burning powder is required. A quick acting powder is also required to burst Shrapnel shell, the charge used being small, and the sharper the action the more readily the shell will be opened without scattering the balls, therefore either pistol or F.G. are used.†

The size of the grain is determined by the sieve through which the grain is passed in manufacture, the sieves are distinguished according to the number of sub-divisions in a linear inch, thus an 8 mesh sieve would have 64 holes in a square inch.

In the Appendix will be found Regulations for Gunpowder Magazines, issued with Army Circular, July 1874, where rules are given for the reception, conveyance, storage, classification, and examination of gunpowder. It will be enough here to give the *serviceable* classes of powder, which embrace "Service," "Blank," and "Shell," (the term *Service*, is applied only to powder used for firing projectiles).

\* Experiments carried on by the Committee on Explosives showed that some L.G. powder gave a lower pressure when fired out of an 8-inch S.B. gun than R.L.G. did, it also gave less velocity. This would seem to contradict the statement as to the effect of the size of grain on the rate of burning, but the fact is, that the density of L.G. and also of the earlier manufacture of R.L.G. varies, and thus complicates the question.—Extracts, Vol. IX., p. 150, 151, 152.

† R.F.G. will answer as well as F.G. for the charge of the 7-pr. gun, and for the bursting charges of Shrapnel shell.



Class.	Designation.	Description.
I.	Service - -	1. All new powder. 2. All returned powder (including cannon cartridges) which, on examination, may be found uninjured.
II.	Blank - -	1. Powder from broken-up cannon cartridges, unless specially placed in Class I. 2. Powder from broken-up S.A. ammunition.* 3. Service powder found dusty or broken in the grain at periodical inspections, or on return; except in the cases of R.L.G., R.F.G., and R.F.G. <sup>2</sup> powders, which if only dusty will be re-dusted for service.
III.	Shell - -	1. Powder found too dusty for Class II.

By the above it will be seen that the only difference between the classes is in the condition of the powder, and, to put it briefly, we may say that *Service* powder is equal to new, *Blank* is slightly dusty or broken in the grain, while *Shell* is too dusty for *Blank*.

At first sight it may seem strange that *Blank* should be a better variety than *Shell*, the first being only used for drill, while the latter is used on service; the fact is, however, that a very dusty powder would not be used in cartridges, as it would work its way through.

Two varieties of powder are ordered to be wetted, powder taken from shells and from B.L.S.A. cartridges, to avoid the presence of iron, or detonating composition in the magazines.

Powder, although called "shell" in the returns, is not to be condemned unless it actually came out of shells. A great portion of the powder in R.A. charge for filling shells was never in shells at all, while the remainder was issued in flannel bags as bursters.

The following powders are used in connection with rifled ordnance, and rifled small arms. Use of each kind of powder.

*Pebble* is used for the battering charges of all rifled guns of 7-inch calibre and over, and for all service charges of 40 lbs. and upwards. When no "P" is available, R.L.G. will be used. The grain approaches to a cubical form, the length of the sides being about  $\frac{3}{8}$  of an inch. The density is very high, the mean being 1.8. The uniformity of its action is ensured by samples of all "P" powder being tested before it is passed into the service. When fired from an 8-inch S.B. gun, 36 lb. charge, shot, 180 lb., the pressure is to be under 20 ton on the square inch, and the initial velocity to be between 1,420 and 1,480 feet per second.†

Owing to its high density, 125 lbs. of "P" are contained in the barrel.

The charges of "P" powder are considerably larger than the charges of R.L.G. for the same gun, thus the battering charge of the 10-inch

\* Powder obtained by breaking up breech-loading small-arm ammunition should be at once thoroughly wetted, as it may contain small particles of detonating composition. In this state it is useless except for extraction of saltpetre, and will therefore be placed in Class VI. All powder emptied from shells is also ordered to be wetted.

† The methods employed for testing the pressure will be found in the Preliminary Report of the Committee on Explosives, p. 4.

Crusher gauges are inserted into the gun containing small cylinders of copper, to which the pressure is transmitted by a piston; the compression these cylinders undergo gives an indication of the pressure of the gas. By subjecting similar cylinders to the pressure of a fixed number of tons the amount of compression caused by various weights is ascertained and tabulated. By means of these tables the relation is obtained between the amount of compression undergone by the cylinders in the gun, and the pressure to which the compression is due.

gun is either 70 lbs. "P" or 60 lbs. R.L.G. In order to enable the cartridges to fit the same packing cases or zinc cylinders, the diameters of the "P" powder cartridges are larger than those of the R.L.G. (see page 184).

The comparative pressure and velocity given by R.L.G. and "P" may be seen from the following instance.

The mean pressure in the powder chamber of the 10-inch gun, charge 70 lbs. "P," projectile, 400 lbs., was 15.7 tons per square inch, and the velocity at 50 yards was 1,412 feet; while the mean pressure given by 60 lbs. R.L.G. was 17.9, and the velocity 1,328 feet.\*

The reason why there is an increase of velocity when "P" powder is used, is because, although the pressure is lower in the powder chamber, it is kept up longer in the bore than is the case when the quicker burning R.L.G. is used, the velocity depending upon the pressure and the space over which it is exerted.

Extracts,  
Vol. IX., p. 14.

It is found that the recoil of the gun is more violent when "P" powder is used, this incidentally shows that the strain on the gun is less, as the force of the powder is expended by making the mass recoil, and not by exerting a strain upon the particles of the metal, of so sudden a nature, as to tend to tear them asunder; in fact, the slow burning powder gives sufficient time to allow the gun to recoil and thus ease the strain. The very opposite takes place with a rapidly burning explosive such as gun cotton, which is stated to occasion a recoil only  $\frac{2}{3}$  that of gunpowder.

Bloxam's  
Chemistry,  
p. 507.  
Service R.L.G.

*Service R.L.G.* is at present used in the S.S. for full charges for R.M.L. guns of 7-inch and upwards, under 40 lbs. but when the stock of *L.G.* is exhausted it will be probably used for all charges under 40 lbs. of *L.S.* as well as S.S. rifled guns, except battering charges, and the charge for the 7-pr. R.M.L. gun. Where no "P" is available, R.L.G. is substituted for it. R.L.G. is in future to be used with R.M.L. field artillery.

The size of the grain is determined by its passing through a four mesh sieve and resting on an eight mesh. Its density is 1.68. This applies to all powder made since 1870, but powder of early manufacture varied in density and consequently in regularity.†

It is tested by firing from a 9-pr. R.M.L. gun, and must give an initial velocity of  $1,410 \pm 25$  feet a second, using a 9-pr. shot and a charge of  $1\frac{3}{4}$  lbs.

It gives a higher velocity than *L.G.* powder, and what is more important, all of recent manufacture is uniform in quality, and may be depended upon for accuracy of range from rifled guns.

An instance of the pressure exerted has been given above; for the comparatively small charges made up of R.L.G. the pressure is not so important, as the abnormally high pressures do not take place which are found to occur when a quick burning powder is used in large quantities.

It is a singular fact that even in firing blank charges from heavy guns, high pressures have been developed when using R.L.G. powder; firing a blank charge of 30 lbs. in an 8-inch gun, a pressure of  $15\frac{1}{4}$  tons was given on a gauge in rear of the powder chamber, and  $9\frac{3}{4}$  tons on a gauge in the centre, and 9 tons on a gauge in the front of the powder chamber. The Committee considered that the pressure of  $15\frac{1}{4}$  tons was local, and that the lower pressure fairly represented the mean pressure.‡

\* A large amount of information on this subject will be found in "Extracts, Vol. X., p. 80."

† Preliminary Report, Committee on Explosives, p. 10.

‡ Extracts, Vol. IX., p. 151.

*Service L.G.* is at present used in the L.S. for all S.B. and B.L. guns, and for the full charges of R.M.L. guns under the 10-inch (except the 7-pr.); and in the S.S. for all S.B. and B.L. guns, and for R.M.L. guns, 80-pr. downwards, 7-pr. excepted. The size of grain is determined by its passing through an 8, and resting on a 16-mesh sieve. It is readily known from R.L.G. by the absence of glaze.\*

Some trials made by the Committee on Explosives showed that L.G. powder gave less pressure and velocity than some R.L.G. tried against it, but it must be remembered that powder of early manufacture is far from uniform, and these trials can only be taken as a general indication of the action of these powders. The Committee report that there need be no hesitation in interchanging L.G. with R.L.G. in wrought-iron guns, on the ground of danger to the guns, but the substitution would be attended with a falling off in muzzle velocity, power, and shooting qualities. It becomes important to officers to know what powder they are using, and therefore all cartridges made up with L.G. powder for rifled guns are marked with the letters L.G. in red.†

*Service R.F.G.*—Used for rifled small arms, except the Martini-Henry and pistols; for 7-pr. R.M.L. guns, and for the bursting charge of Shrapnel when F.G. is exhausted. The size of grain is determined by its passing through a 12 and resting on a 20-mesh sieve. Density, 1.6.

*Service R.F.G.<sup>2</sup>*—Used for the Martini-Henry cartridge. The size of grain is determined by its passing through a 12, and resting on a 20-mesh sieve. Density, 1.72. To give a muzzle velocity when fired from the Martini Henry, of between 1,290 and 1,340 feet per second.

*Service F.G.*—This powder is no longer made; it is used for S.B. small arms, and for the charge of the 7-pr. R.M.L. gun, and for the bursting charge of Shrapnel shells. The size of the grain is determined by its passing through a 16, and resting on a 36-mesh sieve.

*Service Pistol.*—Used for Colt's and Dean's pistol, and for the bursting charges of Shrapnel shell. The size of grain is determined by its passing through a 44, and resting on a 72-mesh sieve. As before pointed out, the quickness of its action renders it specially suitable for Shrapnel shell; and also it is suitable for the short barrels of pistols, where a slower burning powder would not be consumed.

The above are all the service powders employed, that is, all the powders used in connection with projectiles.

We now come to the lower classes of serviceable powders. It will be remarked that there is no shell powder of the R.L.G. or R.F.G. powders in the service at present; these powders, if only dusty, are redusted, and restored to the 1st class. Directions as to the reduction of the serviceable powders to the lower classes will be found in the Appendix, p. 278.

*Blank R.L.G. and L.G.*—For blank charges of all descriptions of rifled and S.B. ordnance, including the *reduced* charges for 9, 8, and 7" R.M.L. guns.

*Blank R.F.G. and F.G.*—For blank small arm cartridges of every description (L.G. may also be used for blank S.A. cartridges). These

\* The density of L.G. and early manufactured R.L.G. cannot be given; L.G. has been found to vary from 1.6 to 1.78.—Preliminary Report, Committee on Explosives, p. 10. Handbook of Manufacture of Gunpowder, p. 53.

† § 1967, Changes in War Stores, directed that rifled guns should be examined after every 25 rounds, when L.G. was used; but this was cancelled by § 2087.

See Extracts, Vol. X., p. 117. At 5° elevation, charge 8 lbs., the mean difference of range (10 rounds fired) of the 16-pr. was 13 yards with R.L.G. and 71 yards with L.G.



powders may also be used for blank charges of ordnance where there is a surplus store.

Shell L.G. : *Shell powder L.G.*—For the bursting charges of all shells, rifled or S.B., except Shrapnel, and the 6, 9, 12, and 20 pr. segment shells, for which *F.G.* is to be used.

Failing shell powder the higher classes of powder must be used. The only reason for using the inferior powder is to prevent waste; no doubt the better the powder, the more effective would be the shell. The effect of firing powder in a shell is to set it back in a hard dense mass; unexploded shells have been recovered with the powder converted into a solid body, so hard as scarcely to be cut with a copper tool. This must to some extent lessen the explosive force of the powder, as the flame cannot penetrate the mass as rapidly as it would do were the powder loose.

Mealed powder. Mealed powder is largely used in the R.L. in the manufacture of ammunition. There are two kinds :—

(1.) *Mealed Powder.*—Passes through an 120-mesh sieve. It is ordinary powder reduced to an impalpable dust; its use is due to its easy ignition and rapid rate of burning. It is used where great regularity of burning is not required, for instance, in quick match, portfire composition, friction tubes, &c.

(2.) *Pit Mealed Powder.*—So called because it is made from gunpowder specially prepared, the charcoal having been charred in pits instead of in cylinders, as is the case with the service powders. It passes through an 120-mesh sieve. It is used for fuzes where great regularity of burning is required. Experience shows that it answers the purpose, but why it does so is not easily to be explained.\*

Liability of  
gunpowder to  
explode by a  
blow or by  
friction.

Too much stress cannot be laid on the fact that gunpowder can be exploded either by a blow or by friction; this forms a clue to most of the precautions which should be taken in dealing with it. When they are carefully observed the risk of an explosion is but small; indeed, in a magazine where it is unnecessary to handle loose powder, an accident can hardly take place unless the rules are violated. I can find no record of an explosion in any large Government magazine in England.

Some attempts have been made experimentally to determine the amount of force required to explode gunpowder. It is necessary to remember that we must consider, (1) the hardness of the surfaces with which the powder is struck; (2) the intensity of the blow, which will depend upon the size of the surface struck; (3) the thickness of the layer of the powder and the condition it is in, whether in grains, or as mealed powder.

Supposing the force of the blow is constant, such as is given by a weight dropping a fixed height, we may say that the harder the surfaces, the smaller the area struck, and the thinner the layer of powder, the more likely the powder will be to explode.

Experiments carried out in the Chemical Department of the Royal Arsenal showed that a 50 lb. weight falling 36 feet on a surface of one

\* No doubt the charcoal prepared in cylinders is much more uniform in quality and would naturally be expected to answer best. The reason is possibly due to the fact that the pit charcoal is less thoroughly charred than the cylinder, and hence will burn more rapidly. The object aimed at in adding mealed powder, is to increase the rate of burning of fuze composition, and it is found as a rule that quick burning compositions burn more regularly than slow burning ones, thus a composition can be made to burn with more regularity at the rate of one inch in five seconds than at the rate of one inch in ten seconds. Possibly the weak burning composition does not give a sufficient rush of gas to keep the vents clear, and if this is the case, the varying pressures would alter the rate of burning.

square inch, the surfaces being brass, having mealed powder  $\frac{1}{20}$ -th of an inch thick spread between them, exploded the gunpowder.

The same weight falling on a surface of  $\frac{1}{4}$  of a square inch, exploded the powder with a drop of 10 feet.

This result coincides as nearly as possible with what would be expected; having diminished the surface by  $\frac{1}{4}$  we should have anticipated an explosion with a fall of  $\frac{1}{4}$  of that it previously required.

In the foregoing experiment we should therefore have expected it to explode with a fall of 9 feet, while it actually required 10.\*

The important fact to remember is, that the more we diminish the surface, the more readily will the powder explode; thus, if in the above experiment we diminished the surface to the  $\frac{1}{8}$ th of a square inch, we should expect the weight to explode it with a drop of 1 foot.

In dealing with gunpowder, we are likely to have a small amount of powder dust about, and by striking this, explosion may take place, especially if the surfaces are hard, an accident is likely to occur.

The effect of various surfaces is well shewn in an experiment carried out in the Royal Arsenal in 1872:—

“A 25 lb. weight was allowed to fall 2 feet on small packages of gunpowder consisting of about 5 grains of Government powder wrapt in tin foil, so as to exclude any possibility of a spark reaching it.”

Artillerist's  
Manual, p. 52.  
11th Edition.

The packages were placed between two metal plates, and 10 blows were struck, using different metals. When steel was used the powder exploded every time; when one brass and one steel plate were used it exploded 4 times out of 10 trials; when both plates were brass it exploded twice out of 10. When lead plates were used there was no explosion even with a fall of 40 feet.

This shows the advantage of covering the floors with some soft material when moving powder, of using soft metal, such as copper (though this alone will not afford complete safety, as if gunpowder is hit hard enough with copper surfaces, it will go off); and above all, the necessity for perfect cleanliness, as if loose powder is allowed to escape there will always be risk. If any grit or sand is allowed to collect in the passages, the danger becomes great, as grit is harder than any metal, and the sharp points coming in contact with powder dust, would be just the most favourable conditions for an explosion.

In a magazine, such a state of affairs could only be caused by neglect of the regulations laid down, which are given in the Appendix, p. 272.

There have been no experiments to determine the amount of friction that is necessary to explode gunpowder, but we have unfortunately, abundant evidence that gunpowder will explode by friction against the walls of rifled shells when fired, as will be seen further on at p. 24.

The property of exploding from a sudden blow is made use of in Palliser projectiles; no fuze is employed, and the powder is found to explode on the impact of the projectile against iron plates.

---

\* The arrangements for the falling weight are somewhat rough, there is some oscillation, which leads to jamming between the guides, and the friction must be considerable. The powder was placed between two brass plates, and work must have been expended in flattening the upper plate, thus cushioning the blow to some extent.

Gunpowder possesses the property of standing climate well, when properly made. Saltpetre is not readily deliquescent when pure, the glaze and density of the powder aid to preserve it from damp; still in very damp climates, or in a damp magazine, it is necessary to keep powder in metal cases, the air being excluded by luting. (See Chap. VII., p. 59.)

It is found advisable not to allow the gunpowder to be in direct contact with metal, as if there is the least damp, the saltpetre will attack and corrode it, thus spoiling the powder. Again, paper is found to cause gunpowder to deteriorate, as it is apt to absorb and retain damp, which causes the saltpetre to be absorbed into the paper.\* This can be overcome by varnishing the paper.

Extracts,  
Vol. X., p. 83.

The explosive force of gunpowder in a closed vessel is believed not to exceed 35 tons per square inch,† and the Committee on Explosives state that this pressure would probably never be reached in the bore of a gun, unless *wave action* is set up.‡

For the examination of gunpowder, see p. 269, 278.

---

## CHAPTER II.—GUN COTTON. INGREDIENTS USED IN LABORATORY COMPOSITIONS, THEIR PROPERTIES, AND METHOD OF MIXING THEM.

---

Gun cotton.

Gun cotton is manufactured at Waltham Abbey and is obtained from the trade; as yet it is little used in the R.L., but its use will probably be extended before long, so it is desirable to give a brief account of its leading qualities.§

The composition will best be understood by giving a sketch of its manufacture, omitting all details.

The cotton is thoroughly cleansed from all fatty or foreign matter, and thus becomes pure cellulose. The cotton is steeped in nitric acid, to which three parts by weight of sulphuric acid have been added, the sulphuric acid acting by combining with the water set free by the nitric acid,|| so as to keep the acid up to the proper strength, finally the cotton is washed so as to get rid of any free acid which would be fatal to the keeping qualities of gun cotton.

---

\* Some B.L. cartridges were found deteriorated at Dover from this cause, in a magazine where the M.L. cartridges were in good condition, this was traced to the unvarnished paper cylinders with which the cartridges were made up.

† Experiments by Captain A. Noble, of Elswick.

‡ Wave action is a name applied to the abnormally high pressures which are found to occur in a gun when very high charges are used, they appear to be local, and do not give increased velocity to the shot.

§ Much information will be found in Bloxam's Chemistry, 1st Edition, p. 500; Abel's recent Investigations and Applications of Explosive Agents, 1871; Abel's Contributions to the History of Explosive Agents (from the Proceedings of the Royal Society, No. 150, 1874); Extracts, Vol. VIII., p. 59, Vol. IX., p. 37, Vol. X., pp. 28, 179; Report of Committee on Storage and Transport of Gun cotton, 1872.

|| Cellulose, by the addition of nitric acid, is converted into gun cotton and water, the latter is taken up by the sulphuric acid.

The exploding point of gun cotton is about 343° F., considerably § 2385. lower than that of gunpowder, a quality which is taken advantage of by using it as priming for fuzes when very small charges are used.\*

The rate of burning much depends on the mechanical condition, it can be retarded by various devices, such as twisting it into skeins, but it is most largely used in the form of solid discs or slabs, produced by the pulping process ; it can be moulded into any form required.

When gun cotton, perfectly unconfined, is ignited by a flame, or by a heated body, it burns quietly and rapidly with a bright yellow flame ; if, however, the cotton is confined in a strong case, even of wood, the action is very different, it explodes with great violence, and the strength of the explosion will depend upon the thickness of the case ; to develop it fully a strong iron case is required.

If gun cotton is ignited by a blow it detonates† with great violence, it may also be detonated by the action of various detonating bodies, even when unconfined, of which fulminate of mercury is found the most suitable. It is this property that renders gun cotton so valuable for torpedoes, destroying stockades, bridges, &c.

It is found when about 5 grs. of fulminate of mercury are enclosed in a tin tube, and ignited in contact with a disc or slab of gun cotton, that a most violent detonating action is set up. To guard against any chance of failure, 20 grs. of the fulminate are used. Various means are used for igniting the fulminate, the service detonators will be found at page 72.

It is essential that the gun cotton should be in a compact form such as that produced by the pulping and subsequent pressing process, as light flocculent gun cotton can not be so readily detonated by the fulminate.

When the detonation is required to spread from one disc to others, it is not necessary to have them absolutely in contact, rows of discs from 30 to 40 feet in length, with intervals of from  $\frac{1}{4}$  an inch to 1 inch, have been detonated by a disc at one end, set in action by a fulminate detonator.

The discs are made with a small central hole into which the detonator can be inserted.

It is found that not only can dry gun cotton be detonated by the action of fulminate of mercury, but also that the same effect is produced in wet gun cotton, if sufficient fulminate be used, a dry disc detonated by the usual amount of fulminate is, however, more convenient to start the action ; a half pound dry disc will be found sufficient to communicate the action to a large charge of wet gun cotton.‡ This is most important, as it allows of the use of wet gun cotton in torpedoes, and also does away with the risk connected with storing dry gun cotton.

When gun cotton is detonated, its action is so very rapid§ that no confinement is required, thus there ceases to be any necessity for using a strong case for torpedoes, or for tamping mines, and it can be used to cut down stockades, &c., by simply attaching the discs loosely to the obstacle.

\* The products of explosion are carbonic oxide, carbonic acid, water, and nitrogen ; the first is highly dangerous in confined spaces, as it is an active poison and inflammable.

† I can not find any clear definition of the words *explosion* and *detonation*, but their general sense is sufficiently understood. The main difference seems to be in the rate of ignition, in fact, *burning* runs into *exploding*, and *exploding* into *detonating* ; in the last action, so rapid is the decomposition, that no confinement is necessary to develop its power.

‡ In practice, two half-pound dry discs are used to ensure detonation.

§ The rate at which detonation is transmitted from mass to mass in a row of gun cotton discs ranges from 18,000 to 20,000 feet per second.



Extracts,  
Vol. IX., p. 38. The force of detonated gun cotton is stated to be about four times that of exploded gunpowder, weight for weight.\*

From the experiments given in the footnote it seems that ordinary stockades would be disposed of by using about 2 lbs. of gun cotton per foot run, the discs being in contact and exploded by a detonator. As the discs must be touching, or nearly so, a handy plan would be to have the discs attached to a rod or rods which could be fastened or laid against the stockade.

§ 2082. Gun cotton is issued to the service in discs 3" in diameter and 2" in thickness, weighing about 8 oz. The "primers" or discs to receive the detonators have two perforations. The large discs are used in subterranean and subaqueous mines, (*i.e.* fixed torpedoes); the discs are packed in wooden cases lined with marine glue, holding about 28 lbs. Gun cotton is also issued in the form of flat oblong slabs, having four holes suitable for use against stockades, and small discs are issued for various operations.

Instructions  
for packing  
and storing  
damp gun  
cotton.  
28/5/73. The cotton will now be packed and stored damp, boxes sent to foreign stations have the edges luted with tape and marine glue. When received, the cotton is to be at once transferred to the store tank; the contents of boxes having different dates or marks are to be kept together in the store tanks.

§ 2402. In filling the tanks, ample room is to be left below the lid, fresh water is to be poured in to fill the tank, and the plug at the bottom of the tank is then to be removed. When the water has run out, the plug is to be replaced and the lid screwed on. Every three months the tanks are to be opened, the cotton inspected, and the tanks filled as above. The tank will contain a ton of damp gun cotton.

Report of Com-  
mittee on  
storage of gun  
cotton.  
Extracts,  
Vol. XI., p. 153.  
1872. It must be remembered that the safety of the gun cotton depends on its being kept damp, if dry it would have to be treated as any other explosive. An experiment carried out in May, 1873 showed that a ton of wet gun cotton did not explode when exposed to the action of fire in a strongly built magazine.

Abel's investi-  
gations on  
explosive  
agents, p. 22.  
Extracts,  
Vol. VI., p. 83. From what has already been said as to the action of gun cotton, it will be seen that it would be a most valuable agent for bursting shells, the qualities which render it unsuitable for the charges of guns are just those required for the bursting charges of shells. Experiments have been carried on from time to time with a view to utilize it in shells. Some 13" mortar shells were fired safely with gun cotton, but on trying it with 7" and 8" rifled shells, the gun cotton exploded with great violence in the gun, one gun was burst and the other rendered unserviceable; the friction against the walls of a rapidly rotating rifled shell being greater than against the sides of a spherical one, accounts for the explosion.

The extraordinary force of gun cotton when detonated would render it most destructive in shells, specially in such shells as Palliser's where the capacity is necessarily small.

Experiments are now being carried on to ascertain whether wet gun cotton can be used in rifled shells in conjunction with a fulminate detonator.† See p. 205.

\* The following experiments illustrate the force of detonated gun cotton:—A stockade was formed of four wooden balks, each 12 inches square, let into the ground about 2' 6" and well strutted behind. A 1 lb. disc of gun cotton was placed in the centre of each balk, the intervals being filled with  $\frac{1}{2}$  lb. discs (10), all the discs were touching. One of the extreme discs was fired by a detonator, when the whole exploded with great violence, cutting down the stockade level with the ground, and hurling the pieces all round.—Extracts, Vol. VIII., p. 60.

An 19-inch brick wall can be destroyed by employing slabs of compressed gun cotton simply placed against it at the rate of  $1\frac{1}{2}$  lb. per foot run.—Extracts, Vol. IX., p. 37.

† An account of experiments with Picric powder in shells, and of its composition, will be found in Abel's Investigations of Explosive Agents, p. 25.

## INGREDIENTS used in LABORATORY COMPOSITIONS.

The combustible compositions may be divided into two classes, those which detonate and those which do not; as an aid to memory it may be remarked that chlorate of potash will be found in the detonating class, and saltpetre in the compositions which do not detonate.

*Sulphur* burns at a low temperature and gives out great heat. It is Sulphur. useful in enabling other ingredients to kindle and burn. Sulphur will be found in all the burning compositions, and in the greater part of detonating compositions, owing to its property of detonating with chlorate of potash.

Sulphur is used in two forms in the R.L., viz., sublimed sulphur, Handbook of manufacture of gunpowder, chapter III. known as flowers of sulphur, and ground sulphur, prepared from distilled sulphur. A full account of the preparation is given in the "Handbook of manufacture and proof of gunpowder."

Sublimed sulphur, though not suitable for the manufacture of gunpowder, answers for most laboratory compositions, but in a few cases ground sulphur is used; it will generally be found in such compositions as may be exposed to the action of water, such as carcass, light ball, and life buoy portfire composition. Experience has shown that ground sulphur answers best for some compositions, and sublimed for others.

*Saltpetre* is used as a source of oxygen, one cubic inch of saltpetre Saltpetre. contains as much oxygen as 3,000 cubic inches of air, and as most of the laboratory compositions burn in a confined space it is absolutely necessary to supply them with oxygen; thus saltpetre is found in all our burning compositions which do not detonate.

Saltpetre is supplied to the R.L. from Waltham Abbey, a full account of the process of refining will be found in the "Handbook of the manufacture and proof of gunpowder, chapter 2." The presence of any salts containing chlorides is carefully provided against, as they would render saltpetre liable to deliquesce, a fault from which pure saltpetre is comparatively free.

Ground saltpetre\* is used in the R.L. It is supplied in a powder fine enough to pass through an 80-mesh sieve.

*Chlorate of potash* is used as a source of oxygen, its use in the Royal Chlorate of potash. Laboratory is owing to the property it has of detonating on being rubbed or struck when mixed with sulphur or sulphide of antimony. It is in all our detonating compositions.† Though not used in the ordinary burning compositions, it will be found in the ingredients of coloured lights. Owing to its powerful action more heat is developed, thus causing the metallic substance on which the colour depends to be thoroughly consumed. Great care must be taken in mixing these compositions as they are liable to detonate.

*Sulphide of antimony* possesses the property of detonating with Sulphide of antimony. chlorate of potash, and may sometimes replace sulphur. It has more-over the property of burning with a long flame or flash which renders it useful in compositions intended to ignite other bodies at a little distance; thus it is used in caps, friction tubes, and carcasses.‡

*Fulminate of mercury* is a most dangerous ingredient to handle, and Fulminate of mercury. should never be dealt with by inexperienced men. It detonates readily

\* The use of so-called pulverized saltpetre in rockets has been abandoned.

† Chlorate of potash when mixed with sugar detonates on the addition of sulphuric acid. Fuzes on this principle having the sulphuric acid contained in a glass vessel were used in conjunction with mechanical torpedoes. The action is said to be somewhat slow.

‡ Sulphide of antimony gives a more violent explosion than sulphur when mixed with chlorate of potash. The peculiar long flash is probably due to the volatilization of the metal.

- on being struck, and is used in such compositions as caps and B.L. fuze detonators. In the Royal Laboratory it is kept wet till required for use.\*
- Magnesium.** *Magnesium* has a brilliant white flame, and is used in light compositions, it is prepared with parafine to preserve it from oxidation.
- Red orpiment.** *Red orpiment* is a bi-sulphide of arsenic, and gives a bright white flame in burning which is useful in light compositions.
- Turpentine, spirit of.** *Turpentine* dissolves rosin in carcasses, it makes a kind of cement, binding the mass together.
- Methylated spirit.** *Methylated spirit* is used for damping detonating compositions, so as to make them into a paste to enable them to be handled, it evaporates without injuring the composition. It is also used to dissolve shellac.
- Charcoal.** *Charcoal.*—We may say roughly that charcoal acts the part of fuel, which combines with the oxygen of the saltpetre, enabling it to burn, and in combining with it forms an expansive gas. It is used in rocket composition and gunpowder.
- Mealed powder.** *Mealed powder* causes compositions to burn readily and quickly, and the rate of burning may to some extent be regulated by the quantity of mealed powder employed.

#### METHOD OF MIXING LABORATORY COMPOSITIONS.

The leading points to be attended to in making up laboratory compositions are:—

1. Purity of the ingredients used.†
2. The proper proportion of each ingredient to be accurately weighed.
3. The thorough mixing, or incorporation of the ingredients.

In order to ensure the mixing being complete, it is necessary to have the ingredients in a state of very fine division, this enables the different bodies to be brought into close contact with each other, and thus ensures their acting on one another when inflamed.

Such bodies as are not supplied in a state of fine division, are reduced to an impalpable powder by being placed in a revolving barrel along with a number of gun metal balls; after being “drummed” for a sufficient time, the ingredients are passed through a very fine sieve,‡ to ensure the powders being sufficiently fine.

There are two different methods of mixing commonly used in the R.L., one consists in placing the ingredients in a revolving barrel, with gun metal balls, and “drumming” them. The second consists in placing them in a revolving barrel, fitted up with wooden arms or fans, in the interior, so arranged that when the barrel revolves in one direction, the fans revolve in the other.

While the above methods are being used for what may be called the *burning compositions*, it is found necessary to adopt another method for the detonating compositions, which would explode under friction or pressure. It consists in brushing the ingredients through a fine sieve with a strong brush;§ such bodies as sulphur and chlorate of potash

\* The fulminate is prepared by the action of alcohol on mercury dissolved in nitric acid.

† Samples of the ingredients are analyzed in the Chemical Department, Royal Laboratory.

‡ In some cases an 80-mesh, in others an 120-mesh, is used.

§ This method seems to have been the old plan for most compositions; it is necessary to brush, not to sift, the ingredients through the sieve, as the last would separate the ingredients instead of mixing them, the lightest finding its way to the top. It is not easy to ensure a thorough incorporation by this plan, it is also slow and cumbrous.

may thus be mixed, but when fulminate of mercury is used, even this method is too rough, and the ingredients are mixed by a man using a fine badger's hair brush, all proper precautions being taken to guard against explosions.

When the ingredients are thoroughly incorporated in proper proportions with a view to form a large volume of gas on explosion, there should be little or no solid matter left, as is the case with gunpowder, but the laboratory burning compositions are, as a rule, required to burn for a considerable time, and the volume of gas evolved is of no importance, hence the proportions employed are chosen with a view to cause them to burn a certain definite time, and there being a residue of solid matter, or slag, is unimportant.

The most important point aimed at is regularity of burning. By increasing the density of a composition, its time of burning will be increased, as there will be more matter to be burned in a given volume, therefore, by subjecting the composition to a very heavy pressure,\* the time of burning is prolonged.

A table of the various compositions used in the R.L. is given on p. 295.

Many of the compositions possess the property of burning under water; as they do not depend on air for the supply of oxygen, water will only extinguish them when it comes into sufficient contact with the burning matter, to reduce its temperature below the point of combustion. When the composition is enclosed in a case, having a vent or vents, and a sufficient amount of gas is generated to give a high pressure when issuing from the vent, the water cannot make its way to the composition, which will therefore continue to burn. This may be illustrated by plunging a portfire, when well lit, into a bucket of water, it will generally continue to burn; the larger natures of carcasses, when well lit, will also burn, and so will the light balls; with the smaller natures, such as the 12-pr. carcass, the rush of gas from the vents is not always strong enough to prevent the entrance of water.†

For the precautions to be taken in laboratory operations, see p. 283.

\* The pressure is generally applied in the R.L. by means of an hydraulic press; in some cases, such as war rockets, the pressure reaches several tons per square inch.

† Rockets will burn and move rapidly under water, but no effectual means have as yet been found to control the erratic course of submarine rockets.



**CHAPTER III. — FUZE HOLE GAUGES.  
GENERAL REMARKS ON TIME FUZES.  
CAUSES WHICH ALTER THEIR TIME OF  
BURNING. METHOD OF PACKING FUZES.  
CAUSES OF BLIND SHELL AND OF PRE-  
MATURE BURSTS.**

Fuze hole  
gauges.

BEFORE entering on the general question of fuzes, it is necessary to mention the various gauges or sizes of the fuze holes of shells which are found in the service. Each size of fuze hole requires a special fuze to fit it, and thus complicates the question of fuzes.

§ 1238.

It has therefore been determined to adopt one size of fuze hole for all rifled shells, and in time, as the ammunition for smooth bores becomes obsolete, all fuzes will be made of the general service gauge, the only exceptions which exist at present in rifled ammunition are the fuze holes for common and segment shells for B.L.F.S. guns. The table below shews the gauge of the fuze holes, and the shells and fuzes of each gauge.

**FUZE Hole Gauges of all Shell and the Fuzes which fit each Gauge.**

Gauge.	Shell.	Fuze.
Large mortar	Large mortar, 13", 10", 8"	Large mortar, time.
Common	S.B. common and Shrapnel	Common, diaphragm, and small mortar, time, Pettman land service percussion.
General service	S.B. naval shells and all rifled shells, except B.L. field service, segment and common.	5, 9, or 20 secs. B.L. or M.L. time. Royal Laboratory screw percussion, and Pettman G.S. percussion fuzes.
Armstrong field service	B.L. field service, segment and common.*	B.L. plain percussion, and for S.S. Armstrong E. time.

N.B.—This table only shows the gauges of both shells and fuzes, not the fuze which is to be used with each nature of shell. Tables giving the fuze for every shell will be found in the Appendix, p. 307.

Adapters.

All shell having the obsolete Moorsom gauge can be converted to the G.S. gauge by using an adapter. This consists of a gun-metal bush which screws into the Moorsom gauge fuze hole, the interior being of the G.S. gauge. There are two distinct adapters, one for spherical shell, 1·38" long; the other for rifled shell, 1·75" long. There are three Marks of the adapter for rifled shell: Mark I. screws in nearly flush with the top of the fuze hole; II. and III. leave a countersink of ·2", which is necessary to receive the naval wad, *see* p. 97. Mark I. can be converted to II., but is available for L.S. without alteration. For method of fixing adapters, *see* p. 103. The above are the only serviceable adapters, obsolete adapters; which do not convert the Moorsom to the G.S. gauge, are ordered to be broken up. The details of obsolete patterns will be found in §§ 693, 284, 771.

§ 1396.

§ 1427.

§ 1838.

\* The 20-pr. B.L. common shell for S.S. has the G.S. gauge.

It is not necessary to give any account of fuzes manufactured for the service prior to 1855.\*

In that year General Boxer introduced his valuable time fuzes which are still used in the service, and which were greatly superior to the fuzes they replaced, both as to accuracy, and facility of preparation.

General  
remarks on  
time fuzes.

Wood† has been adopted for the body of the fuze, a hard durable wood with a grain suitable for turning is required, beech is found to answer well; the wood is seasoned, and is afterwards desiccated by artificial heat.

All Boxer fuzes are conical, this shape having a great advantage over the cylindrical form as there is no risk of the fuze setting back into the shell on the shock of firing, at least not when the angle of the cone is sufficiently great; also, if the wood expands or contracts the fuze will only project or go in a little more, while with a cylinder the result would be either that the fuze would not enter the fuze hole when expanded, or would fall through into the shell when shrunk.

The same pitch of cone is used in all Boxer fuzes. The cone increases at the rate of about  $\frac{1}{10}$ th inch in diameter for each inch in length.‡ The different sizes are obtained by taking different sections of the cone.

The fuze composition is contained in a channel which is not bored completely through the wood, as it is necessary to support the composition to prevent it from setting back on firing. This channel is placed centrally in the body of the fuze, if there are no powder channels, eccentrically when there are, so as to leave room for them. Powder channels are found in fuzes intended for a time of flight of 10 seconds or under. They are essential in fuzes for Shrapnel shells, where the bursting charge is not immediately surrounding the fuze, and consequently a strong flash is required, they also would be necessary in the case of common shell when the fuze is bored short, because the flash would be obstructed by the side of the fuze hole.

By using two powder channels space is gained for the side holes, and thus the fuze can be made to act at shorter intervals of time. The powder channels are, except in the common fuze, connected at the bottom by a groove filled with quick-match, to cause them both to act at the same time, giving a strong downward flash.

\* Prior to this date some Boxer fuzes with a small cone were introduced, but were withdrawn as they were found to set back into the shell on firing. The shells suited to this form of fuze had their fuze holes subsequently enlarged, and shells so altered bear the letters L.C. (large cone).

† Metal was at one time introduced for fuzes for naval shells.

The advantages claimed for metal over wood were chiefly safety, preservation of the composition, and causing the shell to act more violently, as the fuze hole is more securely closed.

Experience showed that the advantages as to safety and preservation of the composition were imaginary, while the closing of the fuze hole was found to be unimportant except in very small calibres of shells. As wood is much cheaper it is now used, and the metal fuzes 7½ and 20 seconds Moorsom gauge are now obsolete. Vide clause 143, A.C., 1869, for detailed instructions as to their disposal.

§ 1838.

‡ The Boxer (wooden) time fuze for breech-loading rifled ordnance was tested before its introduction into the service as follows:—

1st trial. Four 40-pr. shells with fuzes fixed were placed round a 10 lb. cartridge, two of them leaning upon it, and the other two standing fuze uppermost. The charge was exploded and none of the fuzes ignited.

This experiment was repeated five times.

2nd trial, with fresh fuzes.

3rd trial, with fresh fuzes.

4th trial, with fuzes of 3rd trial.

5th trial, with fuzes of 2nd and 4th trials.

None of the fuzes exploded, or were blown out of the shell, or loosened in any way.—Extracts, Vol. II., p. 62.

‡ The exact rate of increase is 1 in 9·375.

In all time fuzes the last hole in the row is bored through into the composition to ensure the action of the fuze when fixed in the shell without preparation.\*

In all time fuzes it is desirable that they should not be liable to be ignited before they are "uncapped," as otherwise fuzed shell would be endangered by sparks, or by a neighbouring explosion,† this is attained in the common fuzes by covering the head with a cap of tin foil, in most of the M.L. fuzes by a copper strip covering the priming‡; while the B.L. fuzes are protected by cardboard and copper discs covering the escape holes.

Stress is laid in drill on the importance of not uncapping the fuze till the shell is placed in the bore.

It will be remarked that the fuzes for rifled ordnance have their heads closed, otherwise they would probably be extinguished when the shell struck point foremost,§ they would also burn much quicker on account of the increased pressure of the air when flying point foremost.

In the M.L. guns the fuze is ignited by the flash of the charge, which ignites a quick match priming, this priming is contained in the head of the common fuzes, and in a groove at the side of the head in the M.L. fuzes. In B.L. fuzes the quick-match is used to convey the flash from the detonator to the fuze composition.

It is an essential point in all time fuzes to drill a small hole in the top of the fuze composition, this roughens the surface and renders ignition certain, if it were not done the hard polished surface of the fuze composition would often fail to be ignited by the priming. The hole is also of use to fix the zero point, or the point from which the burning of the fuze is reckoned, the length of the composition being measured from the bottom of the hole.

Gun cotton  
priming.  
§§ 2285, 2409.

For R.M.L. field guns, gun cotton priming has been introduced for use when firing at high angles with small charges, as the quick-match failed to ignite.

The gun cotton is issued in tin cylinders containing 20 feet of loosely twisted gun cotton and strands of silk for attaching it to the fuze, the cylinder holds enough for about 20 fuzes, it is closed by a band of tape.

---

\* Where there are powder channels, the bottom hole of each channel is bored through, as it is convenient to support the powder by passing quick-match through these holes, of course the fuze acts when it burns down to the first of these holes.

† An experiment was made in the Royal Laboratory at Woolwich in March 1865, to determine how far the M.L. fuzes, protected by a copper strip and tape, were secure in this respect. The result was satisfactory. The following are the details of the experiment. Four 7-inch B.L. common shells were placed upright and a 10 lbs. cartridge exploded in the centre, and this repeated a second and third time with the same fuzes; none of the fuzes ignited. Four 7-inch B.L. common shell were placed round a 10 lbs. cartridge with the fuzes resting on the cartridge, and the cartridge exploded, this repeated a second and third time; one fuze out of 12 may be expected to light.

‡ An experiment carried out in the R.L. in 1870 showed that fuzes having the priming protected by a tape band were not so secure against an explosion near them as those having copper bands. Four fuzes were placed in shells, and the shells standing upright were arranged round a 10 lb. cartridge, three at a distance of two feet, one within a foot of the cartridge; the cartridge was exploded and none of the fuzes ignited. The experiment was repeated with the same fuzes, and the nearest fuze ignited. On a third trial with new fuzes none ignited. Finally, the shells were laid with their heads resting on a cartridge; all the fuzes ignited on exploding the cartridge.

§ It was hoped that this would get over the difficulty of the effect of the pressure which causes a varying rate of burning in rifled guns. This, however, has not been attained.

The directions for use are enclosed in each cylinder and are as follows:—

Uncap the fuze as usual, open out the priming, and wind about 10 or 12 inches of the gun cotton round it—bringing the ends of the priming between the strands of gun cotton; tie the two ends of the latter together leaving about two inches loose, then fix the whole firmly by tying over it a piece of *silk*.

It is well to remember that when the gun cotton is attached, the fuze is liable to be ignited by the least spark, therefore the shell should be placed in the gun as soon as possible after the gun-cotton is attached.\*

The time fuzes of the G.S. gauge have a paper lining to the fuze composition bore.

In hot climates the wood is liable to shrink, and by doing so may leave a space between the wood and the fuze composition, thus exposing the sides of the fuze composition to the action of the flame of the ignited fuze; should this take place, the fuze will have a large surface ignited at once, and will burn very rapidly, so causing premature explosion.

The paper lining prevents this, as it is not liable to shrink; the lining has however the disadvantage of injuring the keeping qualities of the fuze, because a porous paper absorbs moisture. The old fuzes of the common gauge keep far better,† it has already been pointed out, p. 10., that paper in contact with gunpowder is apt to injure it. It is hoped that this defect has been remedied in the last pattern of time fuze, see p. 28.

The ingredients of fuze composition are given in the table, p. 295. This composition however will vary slightly from the proportions given there, no doubt there is always some slight difference both in the purity and the mechanical condition of the ingredients, and so two mixings, though prepared as far as possible in the same way, will not give exactly the same time of burning. The rate of burning of each mixing is ascertained, if it is found too slow a little mealed powder is added, if too quick a little more saltpetre and sulphur, until it is brought to burn at exactly the required rate.

Fuze composition burns at the rate of 1 inch in 5 seconds. This slow and regular rate of burning is due not only to the proportion of the ingredients but to the fixed amount of pressure to which they are subjected.

Mealed powder is used for the 5 seconds fuzes; here again the composition varies, as generally a little saltpetre has to be added to bring down the rate of burning (about 1 oz. of saltpetre to 1 lb. of mealed powder). Mealed powder burns at the rate of an inch in  $2\frac{1}{2}$  seconds, twice as fast as fuze composition; hence it will take only half as long for the fuze to burn from one side hole to the next, when mealed powder is used, (the wood blocks for the 5 and 9 second fuzes are perfectly similar), and the mealed powder fuze can be bored to act at twice as short intervals of time as the fuze having fuze composition.

The above are the only compositions now used in the manufacture of time fuzes, but there is no difficulty in introducing compositions

\* It was found that without quick-match priming the M.L. time fuze would not ignite with certainty when a 10 oz. charge was used in a 16 pr. gun, when gun cotton was used, a 4 oz. charge was found to ignite the fuze. See Extracts, Vol. IX., p. 208.

† Reports received from Mauritius, the West Indies, and other foreign stations, show that the M.L. and B.L. fuzes which have been in store a few years burn long, while the common fuzes, though of much older date, generally burn within the limits allowed.



which burn slower as this can easily be done by reducing the proportion of mealed powder.

The fuzes which were made for the 7-pr. R.M.L. gun illustrate this well, they were all made from the same size wood block and burned respectively 5, 10 and 15 seconds, the last named having the smallest proportion of mealed powder.\* It has however been remarked that the same amount of regularity can hardly be attained when very slow burning compositions are used. The intervals of time also, taken in burning from one side hole to another, are longer the slower the fuze composition burns. This defect was met in some experimental fuzes for the 8" rifled howitzer by adding a third powder channel and thus increasing the number of side holes.

In all fuzes, except the mortar and parachute fuzes, the numbers refer to the time of burning in half second units, thus 2·5 on the 5 seconds fuze, means  $1\frac{1}{2}$  seconds, 5 on the 9 seconds fuze, means  $2\frac{1}{2}$  seconds, 20 on the 20 seconds fuze, means 10 seconds. The 5 seconds fuze reads to  $\frac{1}{4}$  seconds, the 9 seconds fuze to  $\frac{1}{2}$  seconds, and the 20 seconds fuze to seconds.

With Shrapnel shell fired from field guns it is essential to have a fuze which acts at short intervals of time; thus, suppose a shell to be flying at the rate of 1,200 feet or 400 yards a second, in this case the space corresponding to  $\frac{1}{2}$  a second is 200 yards; it is evident that to develop the full powers of Shrapnel shell, we should have a fuze which can be bored to act at shorter intervals than  $\frac{1}{2}$  seconds. Hence the advantage of the 5 seconds fuze which can be made to act at intervals of  $\frac{1}{4}$  seconds corresponding to 100 yards in flight. Even this is rather too long an interval for accurate practice with Shrapnel shell of the smaller calibres.

Only the even numbers are marked on the 20 seconds fuzes, so they can be bored to act at intervals of 1 second. Short intervals are not so essential in this case, as the fuze is used with garrison shell at long ranges, and therefore, as powder channels are not necessary, the side holes are arranged spirally to gain space for marking.

The mortar fuzes are marked with figures indicating inches of composition, the side holes are only marked by indentations (arranged spirally), the inch space having 5 side holes, each hole corresponding to 1 second in time of burning.

By adding a cypher to the figures on the mortar fuzes they will then read to the same unit as the other fuzes, thus 6 on the large mortar fuze will indicate 60 half seconds or 30 seconds, 3 on the small mortar fuze will indicate 30 half seconds or 15 seconds.

The marking in all the short range fuzes begins at 2, except in the 5 second, where it begins at 1, in the 20 seconds (or long range) fuzes the marking begins at 20, where the 9 seconds ends, the last hole which is bored through into the composition is not numbered in Marks I. and II. fuzes, but the marking of the last hole has recently been approved for the Mark III. M.L. fuzes.

In the large mortar fuze the marking begins at 2, indicating 2 inches of composition which, as previously remarked, can by adding a cypher be made to read 20 half seconds, and in the small mortar at 1, which can be made to read 10 half seconds.

The mode of preparing and fixing fuzes is given on page 53.

It will be observed in the instructions for preparing that all time fuzes are to be hammered into the fuze holes so as to fix them securely, except the B.L. fuzes which have detonating composition in the head, these are to be screwed in as firmly as possible by hand.

§ 2485.

§ 2097.

\* These fuzes are now obsolete for the 7-pr., any existing may be used up with S.B. (common) shell. See p. 205.

Time fuzes are proved as to their time of burning before passing them into the service, 15 fuzes out of every thousand made are selected; 10 of these are burnt at rest, the limits allowed for these new fuzes are very narrow. See p. 36. Proof of time fuzes.

The remaining 5 fuzes are fired at Shoeburyness, and the time of burning noted.

As has been before stated, fuzes are found to deteriorate in keeping, specially those with paper linings, the tendency is always to burn long. To allow for this, the limits of burning are enlarged in the high direction for firemasters proof at out stations, (see p. 267), an excess of 10 per cent. being allowed on the nominal time of burning. The low limit, however, remains unaltered, as there is no necessity to increase it; moreover, it is more objectionable for a fuze to burn short than long, as prematures are apt to injure our own troops.

The limits of the common and diaphragm shrapnel fuzes are the same as those of the 9 seconds and 5 seconds fuzes.

The limits of the mortar fuzes are all given in the high direction; as a mortar shell carries a large charge and moves with a low velocity, a short fuze would be most objectionable. The limits for the large mortar fuze are from 30 to 32 seconds, and for the small, from 15 to 16 seconds. Firemasters will allow 10 per cent. over the nominal time of burning.

Hand grenade fuzes also have only a high limit allowed, they must burn between 7.5 to 8 seconds.

Besides the effects of climate, there are other causes which alter the time of burning of fuzes, increased atmospheric pressure\* causes fuzes to burn more rapidly, while diminishing the pressure causes them to burn more slowly. This point has been established both by the experience of officers in the service, and by careful experiments carried out to determine the rate of increase of the time of burning due to diminished pressure. The same class of results has been remarked at Dartmoor and in the highlands of Abyssinia. Influence of the atmosphere on the time of burning of fuzes.

The following rule is sufficiently correct for practical purposes, viz.: Each diminution of atmospheric pressure to the extent of one mercurial inch in the barometer, increases the time of burning by .03, or what is nearly the same thing, by  $\frac{1}{30}$ . The barometer falls about one inch for an increase of 1,000 feet in elevation. Thus at 5,000 feet elevation, the time of burning of a large mortar fuze would be increased by  $\frac{5}{30}$ , and would therefore burn about 35 seconds.†

The effect of varying pressures on the rate of burning, explains to some extent the important fact that fuzes burn at sensibly different rates when fired out of different guns; as a rule, they are found to burn quicker in large than in small guns, probably because the projectiles from the former keep up their velocity better. The following are the average times of burning of various fuzes in different guns, taken from the proof records in the R.L.

The 9 second M.L. fuze burns	10.4 seconds	in 9 pr. R.M.L. gun.
"                  "	9.3	"        64          "
"                  "	9	"        12 in., 25 ton gun.‡

\* Quarter-Master Mitchell, R.A., first brought this fact to notice, and it has been confirmed by experiments carried out by Dr. Frankland, F.R.S. Proceedings, Royal Society, vol. XI., p. 137. See also Extracts, vol. X., p. 297.

† The reason given for the retardation of the time of burning, due to diminished pressure, is briefly this. Each layer of the fuze composition must be raised to the temperature necessary for combustion by heat transmitted from the burning layer above it, when the pressure is diminished the incandescent gases can expand more freely and consequently transmit less of their heat to the layer beneath them, the contact being less close; moreover the cooling due to rapid expansion is well known.

‡ The fuze is not now a service fuze for the 12" gun in the L.S., but is inserted to show how its rate of burning is altered.

We thus see that a fuze whose normal time of burning is 10 seconds, varies from 10.4 seconds in the 9 pr. to 9 seconds in the 12 inch gun. The fuze unfortunately was named a 9 seconds fuze, because it was supposed to burn about that time in rifled guns, and though that is known now not to be the case, still it is not considered advisable to change the name for fear of creating confusion, as it is now well known as the 9 seconds fuze.

In manufacturing fuzes, it is found necessary to avoid using oil on the tools employed in boring the fuze composition channel, as the oil coming in contact with the composition increases the time of burning.

When time fuzes are used with shells fired from rifled guns, they are found to act on direct impact against a bank of earth, or some solid obstacle; the projectile striking point foremost, the fuze is probably driven in. This action is more certain with fuzes having powder channels, than with the long range fuzes.

**Paint.** All the service wood fuzes are painted in black and drab\*, except the 5 seconds, which is painted red and drab, in order that this quick burning fuze may be readily distinguished from the 9 seconds fuze of similar dimensions. The composition of the paint is given on p. 297, it is really more a lacquer than a paint, as it mainly consists of shellac dissolved in spirits. It aids to protect the fuze from moisture.

**Marks.** Besides the numbers of the side holes, each fuze will be found to be marked with a Roman numeral, indicating the pattern or mark, the number of thousand of manufacture, and the date of the month and year on which it was made:—thus, II. 88, 2/68 would show that the fuze was one of the 88th thousand of Mark II., and that it was made in February 1868.

**§ 1006.** The most important marks are the numeral of the pattern and the date; the No. of thousand is chiefly of use to the manufacturer.

**§ 1999.** Fuzes for B.L. guns bear a label directing that “the safety pin is not to be removed before fixing the fuze in the shell.” The proper time for removing the pin is just before placing the shell in the gun.

**Packing fuzes.** The old system of packing fuzes was in zinc cylinders, secured by a tape band, and the common and diaphragm shrapnel fuzes will still be found thus packed in cylinders holding 25 or 50 †; but future issues would probably be made in a similar way to that given below for the G. S. gauge time fuzes.

**§ 1810.** In 1869 the system of packing fuzes, lights, and tubes, and all such combustible stores in tin cylinders containing small quantities was approved. This method has the advantage of not leaving any large quantity exposed to the action of climate after the cylinders are opened.

**§ 1843.** In 1870 the practice of securing the lid of the tin cylinder with solder was introduced, and after a comparative trial with zinc cylinders secured by a tape band was finally decided on in 1871.‡

**§§ 2055, 2217.** Cylinders are made to contain 20, 10, or 5 fuzes; they are almost always issued in the cylinder containing five, this cylinder being used invariably in the field service is the most convenient for general issue, and has the advantage of only leaving a few fuzes exposed when the cylinder is opened. When new, these cylinders are tested in the Royal Laboratory by placing them in water. A cylinder properly soldered can be placed under water for some days with safety to its contents. The jolting of the limbers will no doubt try the cylinder severely, but we have as yet hardly sufficient experience as to how it stands this test.

\* The special fuzes for the parachute lights are painted blue.

† Issues made for the Gold Coast (1873) were by fives in tin cylinders.

‡ There is a difficulty in soldering a zinc cylinder so that it may be readily opened; the solder combines so closely with the zinc as almost to form an alloy; in opening, the zinc is apt to be broken.

The cylinders of fuzes are issued to the Control Department in packing cases, the number of fuzes and size of the case depending on the demand. The cylinders containing 5 and 9 seconds M.L. wood time fuzes are placed in a wood case containing six cylinders; the R.L. screw percussion are similarly packed.

The cylinders should not be opened unless the fuzes are required for use, otherwise the advantage of hermetically closing them is lost. When special inspection is required a fixed per-centage of fuzes should be examined (*see* p. 267), only a sufficient number of cylinders being opened to furnish the required number of fuzes.

The cylinders have a label on the top showing the nature of the fuze, the number contained in the cylinder, the mark or numeral of pattern of the fuze, and the service for which the fuzes are intended; also a caution *not to open the cylinder until the fuzes are required for use or special inspection*. Instructions for use are given on a label on the side of the cylinder, as well as instructions for opening the cylinder.\* In the case of B.L. fuzes a caution is added against *placing the fuzes in a magazine*.

The cylinders are painted black, the top label is printed in red ink for the 5 seconds fuze; the top of the cylinder itself being also painted red, while the cylinders for the 9 and 20 seconds fuzes have the top of their cylinders painted black and the labels printed in black ink.

The chief defects to be guarded against in fuzes are their causing blind shells or premature explosions.

The first defect may fairly be attributed to some fault in the manufacture of the fuze or in its preparation,† such a mistake as firing a shell without a bursting charge will so rarely occur that it may be neglected. In the description of the M.L. fuzes it will be found that Mark I. fuze will not always act when small charges are used; thus a *blind shell* might be caused by improperly using this fuze in field service. The most frequent source of *blinds* seems to be due to boring the fuze too long. If this is done the shell on striking the earth may shake out the fuze; the velocity of the shell being suddenly checked the fuze has naturally a tendency to fly forward; if the practice is over water the fuze may be extinguished by striking the water. It is to be remarked that such a grazing action is very different to direct impact, which, as before stated, will generally make the fuze act.

Causes of  
blind shell.

Practice reports received from out-stations show that *blinds* are sometimes due to fuzes which have deteriorated by keeping, being bored in accordance with the range tables.‡

Suppose a fuze which should burn 10 seconds has increased its time of burning to 12 seconds, it is plain that allowance must be made by boring the fuze somewhat shorter than the length laid down. If *blind* shells are taking place, the first remedy to try is to shorten the length of the fuze. The exact amount of allowance to be given can be readily determined by a "rule of three" sum; thus, suppose that we want to know where to bore a fuze which burns 12 seconds instead of 10, so as to correspond to 6 in the range table, by proportion we find it should be bored at 5. It may often take place that a number of fuzes which burn slowly but regularly may be found at an out-station, and these could be

\* The tin strip securing the box is to be pulled sharply from left to right, the bottom of the cylinder resting against the body.

† Too short a bit may cause a blind fuze, or the bit not being properly fixed in the hook borer. It is possible to bore so as not to pierce the fuze composition. This is very likely to happen when boring the small mortar or the 20 seconds fuzes with the hook borer, unless care is taken to keep the fuze in the proper position.

‡ *See Extracts*, vol. XI., p. 82.



utilized on an emergency by correcting the range table so as to make it suit those fuzes as above indicated.

*Blinds* may occur when using Mark I. B.L. fuze (which has a kamptulicon disc at the bottom) with Shrapnel shell, as the disc sometimes interferes with the action of the primer. This might be remedied by removing the disc before inserting the fuze.

Independent of the fuze, *blinds* have been caused by the use of Mark I. primer in Shrapnel shell, *see* p. 98.

The chief causes of blind shells may be briefly summed up as follows :—

1. From the time fuze not igniting. This would be likely to take place if a Mark I., M.L. fuze was used with a F.S. gun.
2. From the fuze being bored too long, and being extinguished on graze.
3. From a Mark I. primer being used with Shrapnel shell. *See* p. 98.
4. From the primer being covered with any foreign substance, for instance, by rosin which may have worked its way from the interior of the shell.
5. Mark I. 9 and 20 seconds B.L. fuzes with a kamptulicon disc at the base.
6. From a B.L. fuze falling out in flight; these fuzes are screwed in by hand, and consequently not so firmly fixed as the others.
7. From the hole not being bored through into the composition.\*

In the above causes of blinds we have only been considering the time fuzes. When using percussion fuzes a premature or blind may of course be due to any of the causes before-mentioned relating to shells or primers, but as no preparation is required with a percussion fuze, except the removal of the safety pin, blinds or prematures caused by this fuze could only be due to defective manufacture, or to defects inherent in the fuze, unless the fuze was used with a projectile for which it was not designed.

Causes of premature explosions.

Premature explosions are even more serious than blind shells, as artillery frequently fire over their own troops; the effect of a shell with a heavy bursting charge, exploding in a large gun, is frequently to disable the gun. Unfortunately, *prematures* may be due to many causes, but frequently all the blame is laid on the fuze. It will be convenient here to state all the most probable causes of prematures, both those which belong to the fuze, and to the projectile and bursting charge.

It is generally considered that prematures may occur from shells not being properly filled.

Proceedings, O.S.C., 1861, p. 450.

Captain Hewlett, R.N., reports the premature bursting of four 7" B.L. common shell which were half filled with 4 lbs. of powder; a shell fired with a bursting charge of 8 lbs. of powder did not burst prematurely.

§ 954.

Sir W. Armstrong stated that a vacancy, however small, should be avoided, as a tendency to premature explosion would inevitably be the result. The Ordnance Select Committee agreed with Sir William, and an order was issued not to fire shells with less than the authorized charges; the rule now existing is, that shell, except Shrapnel, are to be completely filled.

The great friction due to rotation and the setting back of the powder in an elongated rifled shell renders prematures much more likely in them than in S.B. shells.

Lacquer, necessity for.

Hence the necessity of lacquering the inside of the shell was soon found; at first black lacquer, consisting of equal parts of pitch and asphalte, was used in shells for B.L. guns; the R.L. early recommended

\* A defect in the borer used may possibly cause a blind; in all cases care must be taken to bore till the bit is stopped by the shoulder.

the employment of red lacquer, *see* p. 298; however, the black was used for some years on the score of simplicity and economy.

From time to time prematures occurred and were referred to various causes, until an experiment was carried out in the 7" shunt gun, charge 20 lbs., with a number of shell having black lacquer. Five which were fired, filled and securely plugged, burst; the same happened to 5 fired with time fuzes; the Committee concluded that the fault lay in the lacquer which was very rough. Red lacquer has since been used in shells, but many B.L. shell exist with black lacquer, which we see may possibly cause a premature.\*

It is curious to remark that the frequent prematures were attributed to the fuze, before the experiment showed that they also happened in plugged shells.

Recently attention has been called to the risk of premature explosions by accidents happening when firing common shells from the Woolwich guns. Thus, on the 30th May 1872, 3 10-inch common shell burst when fired on board H.M.S. "Hercules" with a full charge of P-powder, the steel tube of one of the guns was cracked, disabling the gun; wood fuzes were thought to be the cause, and their use was ordered to be discontinued with common shells for R.M.L. guns of 7-inch and upwards, except when fixing a 14 lbs. charge from the 7-inch gun.†

Experience at Shoeburyness confirmed the risk of prematures, and numerous experiments were carried out to trace their origin. They were found to occur in shells filled with powder and securely plugged, thus showing that the fuze was certainly not the only cause at work. Attention was then turned to the shell; it was thought possible that a spongy texture of the iron might give a passage to the flash, and a number of shell were tested by water pressure. 12 9" shell were selected, that stood a ton pressure on the square inch without leaking, and 24 were selected through which the water oozed under this pressure; 9 of the sound shell were fired, and gave two prematures; 12 of the leaky ones gave one premature; all the above shells were filled in the usual way, no bag being used. The remaining 12 leaky shells were fired, having their charges contained in serge bags; there were no prematures; this experiment was confirmed by selecting 20 10-inch shell and 20 9-inch shell, through which the water oozed under a pressure of 1,000 lbs. on the square inch; these shells had their bursting charges contained in serge bags; they were fired with battering charges, and there were no prematures.‡

It was concluded that the prematures arose from no fault in the shells, and the use of bags was recommended and adopted 21/3/73 for all R.M.L. shells of 7 inch calibre and upwards. The above experiments clearly prove that the friction of the powder against the sides of the shell is a frequent cause of prematures; the question still remained whether the time fuzes were not also a source of danger. To test this

\* 50 64-pr. shell were fired without any lacquer; none burst. This experiment does not seem to have been carried farther. Probably much depends on the core being thoroughly removed in manufacture. Sand and iron combined would be just the conditions for an explosion.

† In 1870, 20 of the worst black lacquered 7" B.L. shell in store were fired without a premature. This was considered satisfactory and the shell were considered serviceable. Extracts, VIII., 159.

‡ Two 7" B.L. guns in Madras were rendered unserviceable by the bursting of the shell in the bore. Extracts, Vol. IX., 291. Other instances of prematures will be found in Extracts, Vol. VIII., 37, 158, 160.

§ There have been several instances of prematures. In 1869, two 9-inch shell exploded prematurely on board the "Royal Alfred" (the Superintendent R.L. points out that when shells burst in the gun the fault is not due to the fuze). O.S.C., 1869, p. 272.

¶ See Extracts, Vol. X., pp. 53, 55, 134, 261, 262, 263, 336, 339, in support of statement in the text.

Extracts,  
Vol. I., p. 252;  
Vol. III., pp.  
142, 241; Vol.  
VIII., p. 158.

Extracts,  
Vol. X., p. 260,  
339.

§ 2493.

Extracts,  
Vol. III., p. 331.

a number of 9-inch common shells were fired with M.L. time-fuzes, the bursting charge being contained in a serge bag; 50 rounds were fired with Mark I. M.L. fuze, and 50 with experimental fuzes, in which the powder channels are so arranged as to leave a greater thickness of wood outside them (*see* p. 28). Mark I. gave 4 prematures; the experimental fuzes gave no prematures in the gun, but one occurred about 200 yards off when using a 5-second fuze (bored to act at 2 seconds).\* In these fuzes the side holes were bored beyond the powder channels; the explosion probably occurred at the top side hole. In the Mark III. fuzes the holes are only bored into the powder channels and not beyond them.

The order as to the discontinuance of time-fuzes for the Woolwich guns when firing common shell is still in force, and as no Shrapnel are included in the L.S. equipment, this question is not so important to the R.A. as to the Navy, but it is well to remember that in firing Shrapnel from a heavy gun it is advisable to use Mark III. fuze, which will eventually supersede the other marks for L.S.

A possible cause of prematures in small shell is their being so full that the time fuze cannot be properly fixed; therefore, in filling F.S. shell, care should be taken to leave space for the fuze (*see* p. 51).

It has already been pointed out that prematures may be caused by the wood shrinking away from the composition in fuzes where no paper lining is used.

Of course boring the fuze too short will cause a premature.

To sum up we may divide the probable causes of prematures into two classes.

Prematures due to causes connected with the shell may arise from—

1. Bad lacquer, iron or grit in the shell, or in the R.M.L. shell of 7-inch and upwards from no bag being used.
2. From the shell not being filled.
3. From a weak or defective shell.

The above are probably the leading causes to which prematures are due; it is difficult to overrate the importance of getting rid of them. Our most powerful ships now carry only a few guns, and their broadside might be disabled by one or two common shell bursting in the gun. In the land service, artillery must frequently fire over the heads of their own troops, and a few prematures might cause disastrous results.

The third cause of premature is the one most likely to affect our F.S. Shrapnel shell, where, in order to get a large capacity, the strength is less than that of the common shell; the numbers fired at proof of necessity are small, nor is it possible to test each shell as a gun is tested before issue into the service; the great test is from the number of shell fired at practice; it is desirable that every premature should be reported to the Royal Laboratory, and if possible traced to its source.

Prematures due to the fuze may arise from—

1. A fuze improperly bored.
2. A fuze not home (as when too large a bursting charge is used).
3. A fuze which is too high in gauge, so as to throw the side holes above the bush.†
4. A fuze without a paper lining where the wood has shrunk away from the composition.
5. The powder channels coming high up, and not being sufficiently protected by the wood of the fuze when very heavy charges are fired; this defect has been remedied in Mark III. fuze.

\* *See* Extracts, Vol. XI., p. 58.

† Fuzes of the common gauge are sometimes so enlarged by damp swelling the wood, as to be unserviceable from this cause. This never occurs with fuzes of the G.S. gauge.

## CHAPTER IV.—TIME FUZES.

---

LARGE MORTAR FUZE.—DIAPHRAGM SHRAPNEL FUZE.—COMMON FUZE.—  
 SMALL MORTAR FUZE.—M. L. FUZES, 5, 9, AND 20 SECONDS.—  
 B. L. FUZES, 5, 9, AND 20 SECONDS.—RULES AS TO LENGTH OF FUZE  
 AT VARIOUS RANGES.—ARMSTRONG E. TIME FUZE.—HAND GRENADE  
 FUZE.—PARACHUTE FUZES.

---

*The large mortar fuze* is used with 8", 10" and 13" mortar shells, its construction is shown by the figure (*see* plates, p. 325), the head is protected by a tin cap and disc of pasteboard which is removed by means of the tape when the shell is placed in the mortar. Ignition is secured by means of quick match priming, and also by the hole in the top of the fuze composition. The composition is driven in a channel bored in the centre of the wooden cone; its length being 6 inches, the fuze burns 30 seconds. The figures on the fuze refer to the inches of composition, but as before pointed out, by adding a cypher they will refer to the general half second unit; only 5 divisions are marked to the inch, so the fuze reads to seconds, there are no holes bored at the marks on the fuze, but only indentations. A bit and brace is used for boring this fuze (*see* page 55). The set of implements for boring are contained in No. 5 set garrison.\* The fuze is bored through at 6 inches, (in future manufacture a pellet will be inserted as in the 20 secs. fuzes, p. 31), so it will act without boring at this length, the first hole marked for boring is at 2".

The fuze is ignited by the flash of the discharge and burns till the flame reaches a bored hole through which it passes and explodes the shell. Action.

The first ring on this fuze serves to mark the depth it will enter the fuze hole of 13" and 10" mortar shell, below this at a distance of .9" another line marks where the fuze is gripped by 8" shell. The first hole will only act in the 10" shell, as it falls against the metal in the 13" and 8" shells.

Packed in whole size metal lined case holding 330.

*Diaphragm fuze*, used for diaphragm Shrapnel shell. The arrangement for protecting the head, and for the ignition is similar to that given above. Four holes are bored through the top of the fuze to secure the quick match. The channel for the fuze composition is bored eccentrically so as to give space for two powder channels, one of which is

Issue.  
Diaphragm  
Shrapnel  
fuze.

---

\* Instructions for the preparation of all wood time fuzes are given on p. 53.

shown in the section (*see* plates, p. 325). The main channel is driven with fuze composition, the powder channels are filled with pistol powder, and the powder in each channel is supported by a piece of quick match passing through the lowest hole, by means of which the flame explodes the shell if the fuze is not bored. A groove cut in the bottom of the fuze with a piece of quick match laid in it unites the two powder channels. Holes are bored through into the powder channels, filled with powder and protected by clay being pressed upon them. They are covered externally by varnished paper.

The length of fuze composition is one inch, the fuze burns 5 seconds, and it is marked on the side channels up to 10 half seconds.\*

- Action.** The flame from the fuze composition ignites the powder in the channel, which explodes, giving a strong flash through the bottom holes, both channels explode together as they are connected.
- Issue.** In tin cylinders holding 5 each.

**Common fuze.** *Common fuze* used with S.B. common shell (*see* plates, p. 325). The construction and action is the same as the diaphragm fuze except that the powder channels are not connected at the bottom by quick match. It contains 2 inches of composition and burns 10 seconds, the preparation and action are identical with the diaphragm fuze. This fuze would be used instead of the small mortar fuze, when 12-pr. and 24-pr. shells are fired at short ranges out of the 4½ and 5½ inch mortars. The common fuze may also be used with 100-pr. diaphragm shrapnel shell.

**Issue.** In tin cylinders holding 5 each.

**Small mortar fuze.** *Small mortar fuze* used with common shell fired from 5½" royal, and 4½" cohorn mortars at long ranges (*see* plates, p. 325). It is of the same gauge as the common fuze but longer, containing 3 inches of fuze composition burning 15 seconds, its marking and construction are similar to the large mortar fuze, therefore the intervals between the holes correspond to one second of time in burning, the first mark for boring is at 1 inch.

When used with the 12-pr. shell something must be wrapped round the fuze to make it fit.

**Issue.** 1000 in metal lined case, but in future will be issued in tin cylinders holding 5 fuzes.

**M.L. fuzes.** It is important to have a clear idea of the difference between the various Marks of M. L. fuzes as they cannot be used indiscriminately. The difference between Marks I. and II. is in the amount of priming and in the manner of protecting it. The priming in Mark I. was found not to ignite with certainty when small charges were used, therefore Mark II. was introduced, having an increased quantity of priming wrapped round the groove in the neck of the fuze, this caused a projection, over which the copper strip used in Mark I. could not be placed, so Mark II. has the priming covered with a tape band only, and is not so well protected against risk from fire, when placed in the shell, as Mark I.; it has, however, the advantage of acting with small charges, such as are used with field guns. It was obviously an inconvenience to have two fuzes, one for field service, and the other for garrison service, therefore Mark III. has been introduced which will ultimately become the only M.L. fuze for land service.

§ 2485.

§ 2622.

Several important changes have been introduced in Mark III.

---

\* An obsolete improved Shrapnel fuze may be met with, it may be known by being of small cone and having its head painted red.



They will be more certain of ignition, will be less likely to cause prematures, and will stand climate better than the previous patterns, from which they differ as follows :—

- (1.) The head projects a little farther from the shell, has a larger groove containing the quick match priming ; and differs from II. in having a copper band protecting the priming.
- (2.) The paper lining is reduced by one half its thickness, and is coated with varnish. It is hoped that this may prevent the fuzes from deteriorating, as they do now in keeping.
- (3.) The powder channels are brought nearer to the centre of the fuze, and are slightly reduced in length ; thus protecting the powder from the chance of being ignited by the discharge of the gun. The side holes are not bored beyond the powder channels. The bottom side hole is numbered.

The changes in the 20 seconds fuze are similar to those in the short range fuzes, excepting of course the powder channels.

The following are the regulations for the issue of the various Marks of M.L. fuzes. Regulations  
for issue.

Fuzes of Mark I. (§§ 1417–1953) will be retained in the service, and supplied to the navy for use with all rifled M. L. guns, other than boat and field guns ; and also, so long as these fuzes are available in the district, for land service for the 64-pr. and 80-pr. R. M. L. guns only. § 2485.  
§ 2622.

Fuzes of Mark II. (§§ 2064–2071) will, until the store is exhausted, be supplied for land service, and for naval service for boat and field guns.

Mark III. will be the only fuze manufactured in future for L.S.

*5 seconds M.L. fuze.*—Used for R. M. L. Shrapnel shell G. S. gauge up to the 80-pr. inclusive, it contains 2 inches of composition and burns 5 seconds, the general arrangements will be understood from the drawing of the fuze, *see* plate, p. 326. 5 seconds  
M.L. fuze.  
§§ 1953, 2064,  
2485.

They resemble those of the common fuze, but the head is closed by a gun metal plug, round the pin of which quick match is looped and led through two fire holes to a groove.

This arrangement of the head obliges the fuze to be longer than the common fuze.

A paper lining is introduced to prevent the formation of a space between the wood and the composition in the event of the wood shrinking, which would cause the fuze to act prematurely.

The clay stopping in the side holes is dispensed with, varnished paper alone covering the powder channels, which are united by quick match at the bottom of the fuze.

The fuze is driven with mealed powder, which makes the interval between two consecutive holes correspond to quarter seconds time of burning. The marking of the fuze commences at 1, and the side holes are numbered 1, 1.5 &c., thus enabling the fuze to be bored to quarter seconds.

It is necessary to be able to burst F. S. Shrapnel shell with great accuracy to develop their power, hence the advantage of this fuze, for F. S., *see* p. 121.

9 seconds  
M.L. fuze.  
§§ 1236, 2064,  
2522.

*9 seconds M. L. fuze.*—Used with\* S. B. naval shell, R. M. L. common shell, up to the 80-pr. inclusive, and with R.M.L. Shrapnel shell G.S. gauge, up to 80-pr. inclusive, at long ranges.

It contains 2 inches of fuze composition, and burns 10 seconds at rest.

The construction and size are identical with the 5 seconds, except that fuze composition is used, and consequently the side holes are marked as shown in the sketch. Above the fuze composition the fuze is driven with .4" of mealed powder, equal in time of burning to .2" of the former, to obviate the risk of cracking the composition in boring. It is liable to do this when there is only .2" of composition over the top side hole.

There is an anomaly in calling this fuze 9 secs. All the other fuzes take their name from the time they burn at rest, while this is named from the time the fuze burns in flight in some of the heavier natures of rifled shell. This time however varies with the nature of the gun.

#### 9 Sec. M.L., Mark I.

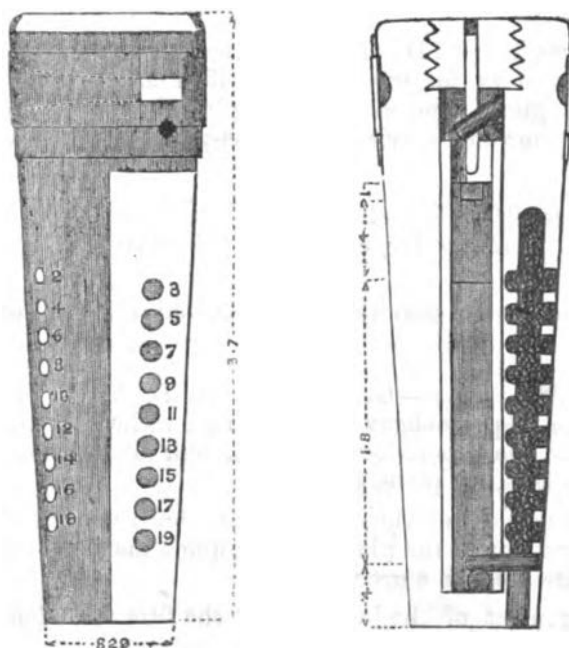

20 second  
M.L.O. fuze.  
§§ 1417, 2071,  
2485.

*20 seconds M.L. fuze.*—Used for S.B. naval, and R.M.L. common, shell, G.S. gauge, garrison service up to the 80 pr., inclusive, at long ranges. It is only used in the F.S. for high angle firing from the 7-pr. gun.†

It has 4 inches of fuze composition burning 20 seconds. Its general construction and action resembles a mortar fuze, as it has no powder channels; but the arrangements as to priming, paper lining, &c., are the same as with other M.L. fuzes. It has a pellet of mealed powder

§ 2360 and  
Errata in  
Changes in  
War Stores,  
Dec. 1872.

§ 2360 and  
Errata, Changes  
in War Stores,  
Dec. 1872.

\* In the S.S. it may be used with the 7-inch R.M.L. common or double shell when 14 lb. charges are employed. It is also the fuze issued for Shrapnel for the 7-inch R.M.L. guns and upwards in the Navy. These shells (Shrapnel) are not now included in L.S. equipments.

† In the S.S. it may be used with the 7" R.M.L. common shell when 14 lb. charges are employed.

pierced, as shown in the section, to carry the flash from the bottom of the fuze. The marking begins at 20, and only reads to even half seconds, as the marking runs 20, 22, &c.

20 Sec. M.L. Mark I.

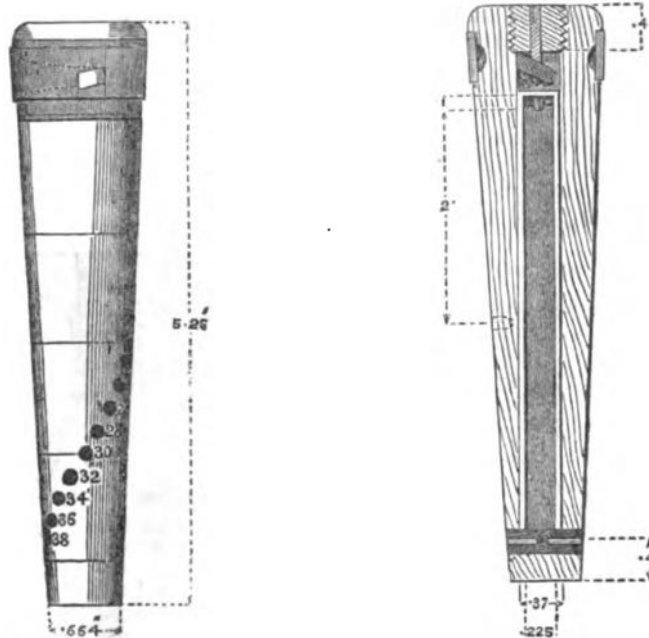

When the fuze composition becomes ignited it burns out of the two fire holes provided for the purpose, in other respects the action resembles that of the diaphragm fuze, p. 27, except the 20 seconds which acts like the large mortar fuze, p. 27.

The fuzes are issued packed in tin cylinders containing 5 (unless specially demanded in cylinders holding 10 or 20), painted black, the 5 seconds cylinder is distinguished by the lid being painted red.

The cylinders are secured by a tin band soldered on.

The B.L. fuzes resemble the M.L., except in the construction of the head.

As there is no windage in B.L. guns, their fuzes have to be ignited by a detonating arrangement which is described below. There is only one Mark of the 5 seconds fuze, but of the 9 and 20 seconds fuzes there are two. Mark I. 9 and 20 seconds had no safety pin, but had a kamptulicon disc on the top and bottom, so as to lessen the chance of their exploding if accidentally struck. Mark II. has a safety pin as described below; \* the two patterns are interchangeable, but Mark II. has a decided advantage as to safety. As before pointed out, Mark I., may cause a blind shell when used with Shrapnel (*see* p. 24). There is a difficulty in fixing these fuzes properly; they are directed to be screwed in by hand and not hammered (*see* p. 54). No doubt it would be dangerous to hammer in Mark I., and it is contrary to regulation to do so with either pattern.

*5 seconds B.L. fuze.*—Used with B.L. Shrapnel shells, G.S. gauge, for F.S. The construction is similar to that of the 5 seconds M.L., Mark I. or II., except as to the arrangement of the head.

As there is no windage the fuze has to be ignited by a detonator. A cylinder, of an alloy resembling gun metal, screws into the head of

\* The safety pin is made of copper. Brass is employed in the percussion fuzes for this purpose, and it is probably preferable, *see* p. 37.



the fuze ; this cylinder contains a hammer, supported by a copper wire, below the hammer is a hollow in the cylinder containing a detonating composition, viz., chlorate of potash, 6 parts ; fulminate of mercury, 4 parts ; sulphide of antimony, 4 parts. A hole is bored through the cylinder for the passage of the flash. The hammer is also supported by a safety pin, which is withdrawn by the tape just before placing the shell in the gun.

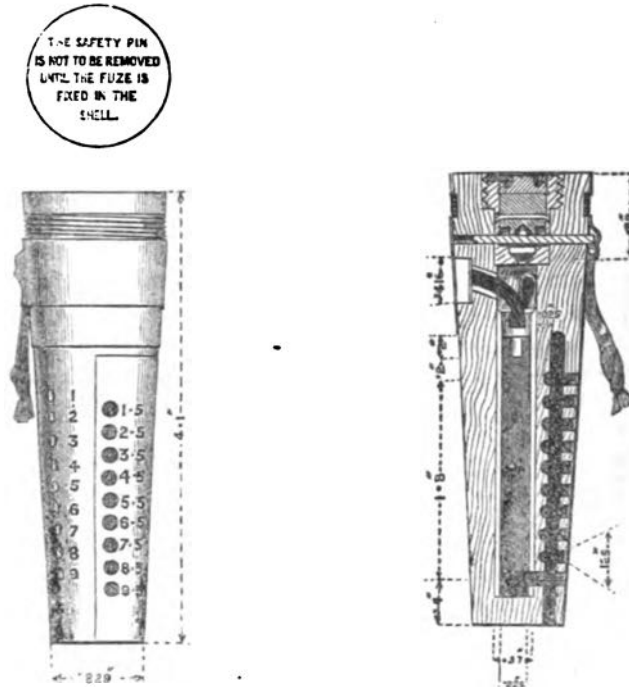

There are three escape holes, one shown in the section, to allow of the escape of gas. These holes are protected by thin copper discs and papier mâché plugs, which are forced out by the gas when the fuze is lighted ; quick match leads up to these holes. The exterior of the head is woolded with wire to keep it from splitting when the detonator is being screwed in.

The ignition is produced by the inertia of the hammer, causing it to shear the copper wire and fall on the detonating composition, thus exploding it and igniting the fuze.

9 seconds B.L.  
fuze.  
§ 1999.

*9 seconds B.L. fuze.*—Used with B.L. common, segment, and Shrapnel shell, G.S. gauge, for garrison and naval service, and with Shrapnel for F.S. at long ranges. The construction is identical with that of the 9 seconds M.L. fuze, Mark I. or II., except the head, which is the same as that described for the 5 seconds B.L. fuze.

20 seconds  
B.L. fuze.  
§ 1999.

*20 seconds B.L. fuze.*—Used with B.L. common and segment shell, G.S. gauge, garrison, or naval service, at long ranges. It is identical with the 20 seconds M.L. fuze, Mark I. or II., except the head, which is the same as that described for the 5 seconds B.L. fuze.

*N.B.*—All the B.L. fuzes are a little longer than the M.L. fuzes, owing to the detonating arrangement.

Issue.

In tin cylinders, as given for the M.L. fuzes, p. 31.

#### *Short Rule for getting the Length of Fuze.*

Divide the number of hundreds of yards in the range by 2 and add 1 up to 1000 yards, 2 up to 2000 yards, and so on for length of fuze in

tenths of inches ; this will be found nearly correct with rifled ordnance. Example. To find length of fuze at 2600 yards for 16-pr. gun,  $\frac{26}{2} + 3 = 16$ . Shrapnel require to be bored a little shorter.

*Short Rule for getting Length of Fuze for Mortars.*

Add 17 to the number of hundreds of yards in the range for the length of fuze in tenths of inches, thus the fuze for 1700 yards will be  $3 \cdot 4''$ .

It must be remembered that all the lengths of fuze given by rules or by range tables must be taken as approximations only to be corrected by practice. As before pointed out (p. 21), the age of the fuze, the height of the barometer, and a variety of other causes affect the rate of burning. When blind shell occur, a shorter fuze should be tried.

*Rules for use of the various Fuzes for Rifled Guns.*

A few brief rules will form a guide to the use of the various fuzes for rifled guns enumerated above.

Time fuzes are not issued in the L.S. for 7" R.M.L. guns and upwards.

The 5 seconds fuze is for use with Shrapnel shell, and is most necessary for F.S. shell, which must be burst within 100 yards of the object ; it can be used up to about 1700 yards with R.M.L. guns, and up to about 1600 yards with B.L. guns (the velocity being less with these guns).

The 9 seconds fuze is used with Shrapnel shell at long ranges,\* with common shell, 7-pr. R.M.L. double shell, and with segment shell (excepting the B.L. field service common and segment shell).

The 20 seconds fuze is used for garrison, common, and segment shell at extreme ranges, and also for the 7-pr. double shell for vertical fire. It is not available for Shrapnel as it has no powder channels.

In all cases, the nature of the gun, whether B.L. or M.L. must be considered. On an emergency B.L. fuzes might be used with R.M.L. guns.

*Armstrong "E." Time Fuze.*

*Armstrong "E" time fuze.*—Is only used by the navy with B.L. segment shells, F.S.

It represents a large class of time fuzes employed by continental nations with Shrapnel shell.†

The construction is complicated and its cost about double that of the Boxer B.L. time fuzes, but it has several important advantages, specially as a fuze for Shrapnel. It can be set to very small intervals, a point of the greatest importance with Shrapnel shell, it can be altered again after setting, and it is open to inspection, so that the officer or the No. 1 of a gun can see that it is correct, instead of depending on those employed in preparing shells at the limber or in the shell room.

It is not necessary to give the various patterns which have been introduced, or to dwell on the various changes in manufacture, as only one nature of fuze is now issued to the service, and the proper fuze may be known by the word "cap" stamped upon the base of the fuze. Various marks may be found in combination with this word, as old fuzes are repaired by having cap composition substituted for the

\* It is the only fuze used with the Shrapnel for the Woolwich guns of 7-inch and upwards. It is also the only fuze issued for Shrapnel for B.L. guns above the F.S. calibres.

† A full account of the fuzes used by European nations up to 1871 will be found in "*Recherches theoriques et pratiques sur les Fusées*," par H. Romberg. The gradual development of the Armstrong class of fuzes can be traced there starting from the Bormann and Breithaupt fuzes, to those used by the Prussians, Austrians, and Swiss.

amorphous phosphorous composition which did not stand exposure to climate and deteriorated by keeping.\*

The fuze being complicated in its construction demands very careful manufacture, and in this respect compares unfavourably with the Boxer fuze, as there are more sources of failure.

Many defects existed in the early patterns, and so brought the fuze into disrepute. The chief faults are:—

- (1.) The fuze occasionally fired when carried in the limbers. This was due to the pellet containing the detonating composition being supported by lead feathers, which gave way under the jolting motion of the limbers. This has been remedied by using a cup-shaped support of thin brass, as shown below. (The cup was proposed by Col. Freeth, R.A.)
- (2.) The fuze sometimes failed to ignite when the detonating arrangement fired. This was due to the hard surface of the fuze composition; the flash from the pellet failed to light it with certainty. This has been overcome by boring a small hole in the ring of fuze composition close to the channel which conducts the flash.
- (3.) The fuze sometimes became unserviceable from the phosphorous composition deteriorating. This has been overcome, as pointed out before, by using cap composition.†

No doubt a prejudice was created by the bad results obtained when using this fuze with segment shell, but these shells should be used with a percussion fuze; no time-fuze will give good results with segment shell (see p. 105).

The following is a short description of the fuze at present issued to the Navy.

"E." time fuze, Mark III. § 2178.

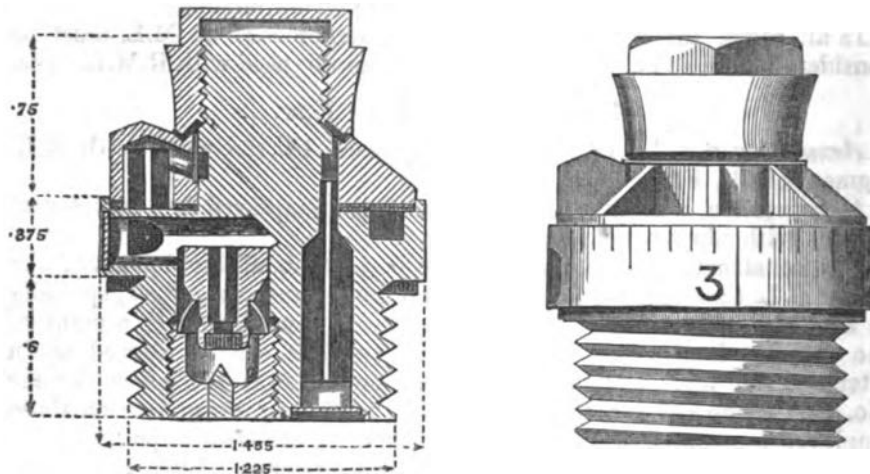

Both body and nut of last pattern E. III are made of gun metal, and the graduations for length of fuze in inches and tenths are marked on the metal rim instead of on paper as in former patterns. The pellet which is supported by a brass cup is filled with R.F.G. powder, secured by thin paper fastened on its base; the detonator in the head consists of

\* Much information will be found in a book by Col. Wray, C.B., R.A., giving the "Changes of pattern and modifications in the Armstrong time and F.S. percussion fuzes since their introduction in 1860," printed at the D.G.O. Office, Woolwich, in 1869; also see §§ 90, 609, 1,294, 1,472, 2,178, 2,496, Changes in War Stores.

† An account of an extended trial of the old pattern of E. time fuze will be found in Extracts, vol. VIII., p. 183.

cap composition (fulminate of mercury, chlorate of potash, and sulphide of antimony), instead of the amorphous phosphorous composition which deteriorated in damp climates. In those lately made a disc of brass .001" thick covers the detonating composition. The word "cap" is stamped on the base of the fuze. § 2178.

The channel by which the flash from the pellet reaches the ring of fuze composition is enlarged in this pattern, and a little hole is bored in the ring of fuze composition to ensure its lighting. The fuze composition is pit mealed powder pressed into a ring or groove which runs round close to the exterior of the fuze body; this composition burns at the rate of 1 inch in 2 seconds, and owing to a metal stop can only burn in one direction, *i.e.* from left to right.

A leather washer and moveable gun metal collar cover the ring of composition. At one part of the collar a channel marked with an arrow (primed with mealed powder driven and pierced) communicates with a groove round the neck of the fuze which contains mealed powder, this groove is connected by a channel with the blowing chamber, which is primed with mealed powder, driven and pierced; a small brass disc closes the chamber.

The moveable collar is kept in its place by a nut which screws on to the neck. The body has a small hole in the side to fit a projection in the Armstrong key used in screwing in the fuze.

See page 55. Stress must be laid on the importance of screwing the nut tightly home when the fuze is adjusted, otherwise the washer will not be tightly pressed down on the ring of fuze composition, and a premature may occur. Preparation.

On firing the gun, the brass cup is crushed in, the pellet strikes the needle, which explodes the detonating composition, the ring of fuze composition is ignited by the flash and burns till it comes to the channel marked by the arrow head leading to the groove in the neck primed with mealed powder, the flash is then instantaneously conveyed into the blowing chamber, and thence into the shell. Action.

The changes recently introduced, particularly the cap composition and the ensuring ignition by piercing a hole in the ring of fuze composition, have greatly improved this fuze.

Divide number of hundreds of yards in range by 6 for length in inches, thus for 1200 yards, length of fuze=2 inches. Short rule for finding length of fuze.

1 in a waterproof bag placed in a cylindrical tin box wrapped in brown paper, 72 boxes in a deal case placed on the sides or heads, the bottom of each tin box is marked "top" to prevent it being placed downwards. Issue.

An "F" time and percussion fuze was introduced in 1867, but it is now withdrawn from the service. § 1473.

### *Special Fuzes.*

*Hand Grenade.*—Used with the 3-pr. or 6-pr. hand grenades. They are readily known from all other fuzes by their small diameter, absence of paint, and by the head being secured only by a paper cap. They contain 1.5 inches of fuze composition which burns 7.5 seconds; the composition is unsupported at the base.\* Hand grenade.

No boring is required; the fuze must be firmly fixed in the grenade, uncapped, and lighted by a portfire. Preparation.

They are now rarely demanded. When men are using them they should be cautioned not to retain the grenade too long in their hands.

\* As the grenades are thrown by hand, support at the base is unnecessary.

- Issue.** 1,200 in a whole metal-lined case.
- Fuzes for parachute lights.** These fuzes in their general construction, preparation, and action, resemble the common fuze. The figures, however, give the time of burning in seconds instead of half seconds; a paper label is pasted above the row of figures with the words "time of burning," and the figures have " " above them indicating seconds. The fuzes are painted blue. Each nature of parachute light has a special fuze.
- 10-inch parachute fuze.** *10-inch Parachute Fuze.*—Has three inches of ordinary fuze composition and burns 15 seconds. The first side hole is numbered 6, indicating 6 seconds; the second row of side holes give the half seconds, beginning at 6·5; the last hole is numbered 15. The fuze is about four inches long.
- 8-inch parachute fuze.** *8-inch Parachute Fuze.*—Has 2 inches of slow-burning composition, which burns 13 seconds. The marking is peculiar, the first side hole is numbered 7, indicating 7 seconds, the top side hole of the second row is numbered 7·75, the next hole in the first row is numbered 8·5, and so on, the fuze reading to intervals of  $\frac{3}{4}$  seconds, the last hole is marked 13. The fuze is about three inches long.\*
- 5½-inch parachute fuze.** *5½-inch Parachute Fuze.*—Has 1·5 inches of slow-burning composition, which burns 10 seconds. The first side hole is numbered 4, indicating 4 seconds; the succeeding holes are numbered 4, 4·75, &c.; the last side hole is numbered 10. This fuze is about 2½ inches long.†
- Fuze for life-saving rocket.** *Fuze for life-saving rocket.* See p. 243.
- The following are the limits of time of burning allowed in manufacture. These must not be confounded with the limits employed in testing fuzes at out-stations given in instructions for proof, p. 267.

	Time of burning.
Large mortar fuze - - -	30 to 32 seconds.
Small " " - - -	15 to 16 "
Common fuze - - -	9·7 to 10·3 "
Diaphragm Shrapnel fuze - -	4·8 to 5·2 "
5 seconds M.L. and B.L. fuze	4·8 to 5·2 "
9 " " "	9·7 to 10·3 "
20 " " "	19·4 to 20·6 "
Hand grenade fuze - - -	7·5 to 8·0 "
Parachute light, 10-inch fuze	14·4 to 15·6 "
" " 8 " "	12·5 to 13·5 "
" " 5½ " "	9·7 to 10·3 "

The reason why no minus limits are allowed for the mortar fuzes is because the shells are fired with a low velocity and contain large charges; hence a fuze burning at all short is to be avoided, as the pieces might fly back to the battery; a minus limit would evidently be most objectionable in a hand grenade fuze, so none is allowed.

\* The 10 and 8-inch parachute fuzes may on an emergency be used with common shells for S.B. guns.

† This fuze would not be used with S.B. common shell as its diameter is too small.

**Manby's fuze.** *Manby's Fuze.*—Is obsolete, as the Manby's shot has been superseded by the life-saving rocket. Their use was to give light so as to allow the course of the shot to be seen at night when firing over a wreck. They burned 12½ seconds.



## CHAPTER V.—PERCUSSION FUZES.

---

GENERAL REMARKS.—PETTMAN L.S. AND G.S. FUZES.—B.L. PLAIN, AND  
R.L. SCREW, FUZES.

---

Wood, though suitable to time fuzes, cannot be used for percussion fuzes, where great nicety of fit is necessary, and where even a trifling alteration of form would prevent the fuze from acting.\* General remarks.

The metal employed must not be liable to oxidise readily; iron was at first tried and proved to be quite unsuitable. The so-called gun metal, consisting of copper and tin, to which a little zinc has been added,† (see p. 311) answers well for the body.‡ Copper wire has been found suitable for suspending any part of the fuze which has to “set back” on the shock of the discharge, while brass wire, being less soft and more elastic, is suitable for safety pins.

Lead answers well for checking rebounds owing to its softness and lack of elasticity, but these qualities render it unfit to be the support to the internal parts of a fuze, at least when it has to sustain the shock caused by the jolting motion of a limber; it answers however as “feathers” or projections destined to be sheared on the shock of discharge.

When percussion fuzes are employed in rifled shells which strike point first, a very simple construction answers, but when shell may strike in any accidental position, the problem is more difficult, as may be exemplified by the construction of the obsolete Moorsom fuze, which had no less than 3 hammers and 5 patches of detonating composition. The difficulty has been successfully met in the Pettman fuzes.

Percussion fuzes are employed for two distinct purposes; they are used in shells intended exclusively to act against solid obstacles, such as earth works, brick walls, or wooden ships; and they are also used in shells employed against troops in the field, as well as in shells directed against buildings and material generally.

For the first purpose it is desirable that the fuze should only act on direct impact, and a very instantaneous action is not required. It will be seen (p. 40) that the Pettman G.S. percussion fuze is specially designed to act only on direct impact.

---

\* Freeburn's concussion fuze was made of wood. The principle is simple and ingenious. The fuze contains a central channel, the lower portion of which is driven with fuze composition, the upper with mealed powder. Three holes closed with three conical plugs with the large part of the cone towards the interior of the fuze lead into the portion of the fuze driven with mealed powder. On firing, the conical plugs are supported by the mealed powder, this burns away rapidly, and when the shell strikes the object the plugs being unsupported fall into the fuze, the flame from the fuze composition passes through the holes and explodes the shell. See *Extracts, Vol. VIII., pp. 85, 153, 348.*

† Adding a little zinc or lead renders the metal easier to turn.

‡ Where heavy charges are used it is essential that the bodies should be strong, hence, a Mark I. R.L. Screw percussion fuze fails in guns over the 9-pr. R.M.L. calibre.

For the second purpose, when used against troops in the open, it is necessary that the fuze should act on graze, and that it should act almost instantaneously, as otherwise the shell has time to rise to a considerable height before bursting, and thus its effect against troops is diminished. Such an action is secured in the R.L. screw, and B.L. plain percussion fuzes. This nature of fuze is absolutely necessary to develop the effect of segment shell when used against troops in the field (*see* p. 105), and good results have been obtained from Shrapnel when using such a fuze at moderate ranges (*see* p. 208).

Safety pins are used in the fuzes which act on graze. They serve to protect the "feathers" in the fuze by taking the shock caused by the jolting motion of the limbers. The "feathers" only come into use when the safety pin is withdrawn, guarding against risk while the shell is rammed home.

It is important to employ a detonating composition which keeps well; the earlier percussion fuzes frequently failed in this respect. Experience has proved that cap composition (p. 296), properly pressed and varnished, resists climate well. The most trying climate is one where great changes of temperature are to be met with in combination with hot damp seasons; parts of India are very trying in this way. The changes of temperature are likely to open the joints of the fuze by alternate expansion and contraction, while the warm damp air is sure to penetrate it, if it finds the least opening. Even in such climates the ordinary percussion caps are found to keep well; this is due probably more to the mechanical condition of the composition, than to any speciality in the composition itself. A very heavy pressure is applied to the composition when placed in the cap, thus forming a hard polished surface not liable to absorb moisture; in addition the composition is protected by varnish.

In all fuzes where pressure can be applied to the detonating composition this system is carried out, but it cannot be done in all cases, and where it is impossible, the greatest care must be taken to close the fuze hermetically. This is illustrated in the construction of the Pettman G.S. fuze.

All percussion fuzes in the service at present (except the B.L. plain which fits inside the shell), are tapped with a screw thread to fit into the conical fuze hole of the shells.\* A fuze having its screwed portion conical can be screwed home much more rapidly than when it is of a cylindrical form, as the fuze will enter some distance into the conical fuze hole before the screw bites. There is no necessity for a shoulder, as a conical screw can not be screwed too far home.

Percussion fuzes are useful in the absence of range finders when firing trial shell. It is difficult when time fuzes are used to judge exactly whether the shells are bursting under or beyond the object, but when the shells are burst on the ground it is easy to determine which side of the object they are bursting.

Percussion fuzes are useful when firing at artillery where a local action is desirable; they would probably be less effective than time fuzes against an open formation of troops.

A great advantage of this class of fuze is that they require no preparation, beyond withdrawing the safety pin in those fuzes which act on graze.

---

\* A number of obsolete fuzes, such as the Moorsom,  $7\frac{1}{2}$  and 20 seconds metal fuzes, pillar fuzes, and Pettman S.S. fuze, may readily be distinguished by their being tapped to fit the cylindrical Moorsom gauge.



For the Navy a proportion of the shell are issued, filled, and fuzed with the Pettman G.S. fuze. Shell thus fuzed are very safe, and not likely to be injured by an accidental explosion in their neighbourhood.

The following brief account of the percussion fuzes in the service will be sufficient, in connection with the drawings, to explain their action:—

*Pettman Percussion Fuze, L.S.*

*Pettman's percussion fuze, L.S.*, used with common shell of common gauge. The fuze hole must be tapped throughout to receive this fuze; this is indicated by a cross cut on the plug.\*

Pettman's  
percussion  
fuze, L.S.  
§ 414.

The body of the fuze is made of gun metal; the ball, cone plug, and steady plug, of a harder alloy to strengthen them; the remaining parts are gun metal except the lead cup.

The section (*see* plate, p. 325) shows the construction.

A strand of quick match closes the fire hole in the bottom plug.

No preparation is wanting with this fuze, which explodes the shell on its striking a hard body, such as a wooden ship, wall, &c. It is not intended to act on graze.

The ball is the only part of the construction which is not quite explained by the sketch; it is roughened by vertical grooves and has a horizontal groove as well; it is coated with a detonating composition composed of chlorate of potash, 6 oz.; sulphide of antimony, 6 oz.; sulphur sublimed,  $\frac{1}{2}$  oz.; mealed powder,  $\frac{1}{2}$  oz., made into paste with methylated spirits and shellac. Varnished gut is tied over it, and a cover of varnished silk over that; these covers both keep off damp and prevent premature explosion.

On firing, the shock of discharge crushes up the lead cup, the ball, cone plug, and steady plug setting back; the sketch shows how the lead cup dovetails on to the cone plug and bottom plug, preventing rebound; the steady plug prevents the ball touching the sides as it sets back, and the irregular motion of the shell in the air causes it to disengage from the ball. On the shell striking the object, the ball, now unsupported, is dashed violently against the side of the body, explodes the detonating composition and fires the shell, the flash passing through holes in the cone and bottom plugs.

Action.

These fuzes are packed by fives in tin cylinders.

Issue.

This fuze was introduced for garrison service; it is not suitable for field guns as it does not act with certainty on graze.

5 per cent. of the different parts are most carefully gauged before being put together; samples of the metals are selected and submitted to the Chemist, War Department, for analysis. After the fuzes are finished 15 per 1,000 are selected for examination and proof. The whole of these are carefully gauged and examined.

Proof.

10 are dropped in a 32-pr. common shell 20 feet on an iron block, in any accidental position. These should not explode. Three of the dropped fuzes are opened and the balls taken out and a weight of  $7\frac{1}{2}$  ounces allowed to fall upon them a height of 22 inches. These should fire.†

The 5 remaining fuzes are fired at Shoeburyness from a 32-pr. gun, common shell, 3 with 10 lb. charges at about 3° elevation to ricochet on water. The object of this proof is rather to test the fuzes under a high charge than to determine whether or not they explode on striking

\* The fuze is fixed in the shell by the key, fuze, and plug, G.S., *see* p. 56.

† This proof is quite distinct from that used by fire masters at out stations, *see* p. 267.

water. As a general rule they do not explode, but they are not specially constructed to stand such a test.

The other 2 are fired with a 4 lb. charge from the same gun, at an oak butt, 200 yards. These should explode.

*Pettman Percussion Fuze, G.S.*

Pettman per-  
cussion fuze,  
G.S.  
§ 1235.

This fuze is arranged so as to act equally well from a S.B., from a B.L., or R.M.L. gun.

It is used with common, double, and segment shells of the garrison calibres fired from rifled guns, and is also used with naval shell fired from S.B. guns.\*

It is specially designed so as to act on impact, not on graze, it will not explode on a shell passing through a wave, but will explode on the shell striking a wooden ship.

Its construction is shown in the plate, p. 327.

The body and top plug are made of gun metal, the cone plug, detonating ball, and steady plug are also made of gun metal, but of a harder alloy to prevent them from altering their shape; the plain ball is made of brass, and the suspending wire is made of copper.

Body.

The body is conical, tapped throughout with a screw, to screw into the G.S. gauge fuze hole, it is about .2" thick, a strong case being essential to resist the shock of a heavy charge. It is slightly hollowed out in the centre to allow sufficient play to the detonating ball, and is also hollowed out at the base to allow the lead cup to dovetail into the recess when it is crushed up. There are two slots cut in the top of the body to allow the fuze to be screwed into the shell, it is tapped at the top to receive the top plug. There is a fire hole in the centre of the base which also serves to allow the cone plug to set back.

Top plug.

The top plug is a small disc of gun metal having two holes in the upper part to enable it to be screwed into the fuze, and a cup shaped recess into which the plain ball fits; it is tapped with a screw thread to fit the body.

Plain ball.

The plain ball is a small solid brass ball.

Steady plug.

The steady plug is a brass disc, recessed at the top and roughed to receive a ring of detonating composition, and having a cup in the centre to receive the plain ball; three fire holes are pierced through it to allow the flash to pass down. The bottom of the central hole is enlarged to receive the projection of the detonating ball. A detonating composition (*see* p. 296) is pressed into the recess and is covered over by a thin copper washer.

Detonating  
ball.

The detonating ball is roughed by a number of vertical grooves and has a deep horizontal groove near the centre, these grooves serve to retain the composition with which the ball is coated, *see* p. 296, and also render ignition certain when the ball strikes against the body. At the top of the ball is a cylindrical projection which fits into the steady plug, and at the bottom is a smaller rounded off projection which fits the cone plug. Over the composition two thin copper hemispheres are placed and united by a piece of shellaced paper, the ball is further protected by covers of varnished gut and silk.

The object of the copper hemispheres and of the copper washer over the steady plug is to bring the sensitiveness of the composition within

---

\* The key, fuze, and plug, G.S., p. 56, is used to fix this fuze.

such limits that the shock of grazing will not explode it, while the shock of direct impact against a solid body will make it act.

The cone plug is so called because it has a conical form in the Pettman L.S. fuze. It is pierced by three fire holes, the central one being slightly enlarged to support the detonating ball, the bottom of the plug contains a chamber which is filled with mealed powder, driven and pierced like a tube, it is recessed near the top of the cylindrical part to allow the lead cup to dovetail on to it, pierced near the base for the suspending wire, and closed at the base by a small cardboard disc. Cone plug.

The lead cup is a hollow cylinder having a flange on the head to fit the recess on the cone plug. Lead cup.

When the fuze has been put together in a perfectly dry state, the top plug, having its edges coated with a waterproof cement,\* is screwed in and allowed to stand until the cement sets. The slot holes in the head of the fuze are then carefully filled with cement, the hole in the base is closed by a cardboard disc, and finally the top and bottom of the fuze are coated with cement. These cementing operations secure the fuze from damp, their importance will be seen further on. Fuzes thus secured have been found to resist water when placed in it for some hours. Securing or cementing Pettman G.S. fuze. § 1719.

A label is attached to the top of the fuze, giving the Mark, number of thousand and date of manufacture, if the fuze has been secured or re-primed, the letters † S. or R. and date of the operation will be found on the label. P. on the label shows that the fuze has been packed in tin cylinders.

\* Venetian red, Stockholm tar, and shellac. § 1634.

† 1. Pettman's general service percussion fuzes having the marks on the label S. or R., followed by a date, and new fuzes commencing with 434th thousand will be considered serviceable, provided they have not been in shells; all other G.S. Pettman fuzes, including those that have been in shells, will be returned to Woolwich as opportunities offer. § 2359.

2. All G.S. Pettman fuzes issued from Woolwich in future will be packed in tin cylinders. This mode of packing commences with the 434th thousand of new fuzes; all other G.S. Pettman fuzes when packed in tin cylinders, will be marked P., followed with the date of packing.

3. The fuzes in shells on board Her Majesty's ships will be left as they are; but if filled shells are deposited at Portsmouth or Devonport during refit, such shells will have reliable fuzes placed in them, which will be protected with a wad as laid down in § 2370.

4. The spare fuzes now on board Her Majesty's ships will be at once exchanged, provided the stores permit of it, for others as described in paragraphs 1 and 2.

5. The fuzes in possession of the Royal Artillery, at home and abroad, should be examined, and any found not marked as laid down will be exchanged for those that are, when there are fuzes available to effect such exchange.

6. Cylinders containing the spare fuzes for Her Majesty's ships will not be opened until the fuzes in them are required for use.

7. On receipt of this order Controllers at every station concerned will send forward a demand on the Controller, Royal Arsenal, Woolwich, for such fuzes they may require to replace those in store not marked as laid down in paragraphs 1 and 2, and to exchange those required for the Royal Navy and Royal Artillery.

8. These demands will be made out on War Office Form 156, and will show in separate columns.

- a. The fuzes required for Royal Navy to meet exchanges.
- b. The fuzes required to exchange those in possession of Royal Artillery.
- c. The fuzes required for Naval Reserves.
- d. The fuzes required for Artillery Reserves.
- e. The number of fuzes available at the station, marked as laid down, and consequently serviceable.
- f. The number of fuzes required to be sent from Woolwich.

Proof. 5 per cent. of parts gauged, samples of metal submitted for chemical analysis, &c. (see p. 311).

15 per 1000 of these fuzes are selected for proof, 10 of these are placed in an iron block and dropped a height of 20 feet on to iron, they should not fire on falling, but may do so when the fuze rebounds and falls a second time, as the first fall puts the fuze in action. This test proves that the interior parts of the fuze are properly arranged, as if the balls were out of position the fuze would fire on the first fall. 3 fuzes are fired from a 7-inch R.M.L. gun, charge 22 lbs, to ricochet on water, these should not fire.\* 2 are fired in a 40-pr. B.L. gun with a small charge, 4 lbs., against an oak butt, or against sand bags 200 yards off; these should fire.

The very ingenious arrangement of this fuze is necessary to meet the difficulty of getting a fuze to act with rifled guns of both natures and also smooth bores. For rifled guns only, a much simpler arrangement answers.

Action. (1.) Suppose a shell fired out of a M.L. gun, the steady plug, ball, and cone plug set back on shock of firing as before, the suspending wire is broken, the lead cup prevents rebound, and the stem of the cone plug protrudes through the base of the fuze; on striking, the action will be the same as in the L.S. fuze, the flash finding exit, through the holes in the cone plug, to the priming and thence to the powder in the shell.

(2.) When fired from a B.L. gun the steady plug may not disengage, and the detonating ball will not act; the plain ball is released by the steady plug setting back, and is caused by the centrifugal force to spin round the circumference of the body over the ring of detonating composition. On shock of striking the object, the ring is dashed against the plain ball and detonates, exploding the shell through the fire holes.

Issue. These fuzes are packed by fives in tin cylinders.

§ 2359. This fuze being specially designed for firing over water is issued to sea fronts of fortifications and to the Royal Navy.

It is to be remarked that it is impossible to protect the composition on the detonating ball by pressure and varnish in the same way as can be done in a cap. It was early found that the damp affected these fuzes and the first remedy was to protect them by unscrewing the top plug, luting it with red lead moistened with shellac varnish, screwing it in again, and coating the top with the luting; this was to be done at out stations as well as at Woolwich.†

§ 1743. Two distinct defects crept in by this operation. (1.) All the precautions given in § 1719 changes in war stores, not being taken, the fuze was frequently put together in a most dangerous position, as pointed out in clause 16, A.C. 1870. This led to all fuzes so secured being recalled, they can be known by the date of repair being marked on them in manuscript; they are not likely now to be met with, but should one be found, the fuze must be looked on as dangerous, and if in a shell treated as directed in A.C. /69, clause 143, the charge of the shell must be wetted through the unloading hole, or if there is no unloading hole the shell should be thrown into deep water. (2.) Neither at Woolwich nor at any out station was any drying process resorted to, nor were they examined, hence these fuzes were still found deteriorated from damp, therefore in November 1870 they were not only secured,

\* This proof is quite distinct from that used by firemasters at out-stations. (See p. 267).

† See Extracts, Vol. VIII., p. 192, where the result of the examination of a large number of Pettman's G.S. fuzes is given; those secured from damp were found to keep very well, the unsecured fuzes had deteriorated.



but taken to pieces and examined in the R.L., the practice of securing them at out stations having been abandoned, and after this date, as before mentioned, they were marked R or S.

Experience has shown the Pettman G.S. fuze to be very safe from prematures.

Both the Pettman fuzes are designed to act on direct impact, but the L.S. may occasionally act on graze (*see* proof, pp. 39, 42), the G.S. on the other hand requires direct impact. The proof shows with what nicety the sensitiveness of this fuze has been brought within the desired limits, as it explodes when fired with a reduced charge from a B.L. gun against wood, and does not explode on striking water when fired with a battering charge from a 7-inch R.M.L. gun.

We now come to the fuzes which act on graze. The smaller the charge the more difficult it is to ensure the action of the fuze. The fuzes about to be described act very well in the ordinary field guns, such as the 9-pr. and 16-pr. R.M.L. and in the Armstrong B.L. field guns, the difficulty occurs in such a gun as the 7-pr. R.M.L. when using a 6 oz. or 8 oz. charge\* where the velocity is too slow to ensure the feathers being shorn off.

A short range is the most trying to the fuze, as when the trajectory is flat the velocity of the shell is but little checked by grazing; these fuzes have however been found to act well at 400 yards and even at shorter ranges. The softer the ground the greater the chance of failure, but our present experience is that these fuzes may be depended on over all natures of ground.† It is also satisfactory to find that prematures are of very rare occurrence.

The fuze introduced in 1862 closely resembles the present B.L. plain percussion fuze in its arrangements, but the latter has two important advantages, viz., cap composition, which, as before pointed out, resists damp; and a safety pin.

#### *B.L. plain Percussion Fuze.‡*

Used with field service B.L. common and segment shell. This is a modification of the Armstrong C. percussion, the improvement con- B.L. plain per-  
cussion fuze. §  
§ 1983, 2620.

\* A letter from the Superintendent of Experiments, Shoeburyness, states that 55 common shell have been fired from the 7-pr. R.M.L. steel gun, 6 oz. charge F.G. powder, using R.L. percussion fuze, Mark I.; 45 acted correctly, 4 on 2nd graze, and 6 were blind. Mark II. acts worse, 6 out of 20 tried at proof were blind.

† See Extracts, Vol. X., p. 351.

A letter in the Royal Laboratory,  $\frac{16,534}{5}$ , gives an account of a trial of the R.L.

percussion fuze, Mark I., from the 9-pr. R.M.L. gun. It states that the fuze acted well on all natures of ground and water at ranges from 825 to 2,250 yards; 138 out of 141 burst on first graze. On boggy ground 102 burst first graze out of 108, ranges 600 to 1,500 yards. On sands 137 out of 143 burst on first graze, range 800 to 1,800 yards. This practice was carried on using the hollow headed rammer (now obsolete) and to this cause three prematures which occurred during the practice were attributed; this rammer used to grip the fuze, and so caused it to come loose in ramming home.

‡ This fuze was known as the "C. Cap" percussion fuze, but the nomenclature was altered to "B.L. plain" by § 2620.

§ By § 2029 a number of obsolete fuzes were called in to be converted to the B.L. plain percussion fuze. They are easily known, as none of them have a safety pin with tape attached to it. When converted, "Cap" is stamped on them.

A "C." percussion screw fuze, which fitted the Armstrong F.S. gauge, is also obsolete.



sisting in using cap composition pressed and varnished, as in gun caps, which experience has shown to stand damp climates well.

**Construction.**

The body is made of gun-metal, and has a rim projecting at the top which ensures the fuze being placed in the correct position in the shell. In the centre of the top, on the inside, is fixed a steel needle, point down; the top is pierced with four holes to allow of the action of the Armstrong time fuze, which is still used in the navy in conjunction with the B.L. plain fuze.

A washer of thin sheet brass closes these holes (it is blown in by the action of the time fuze).

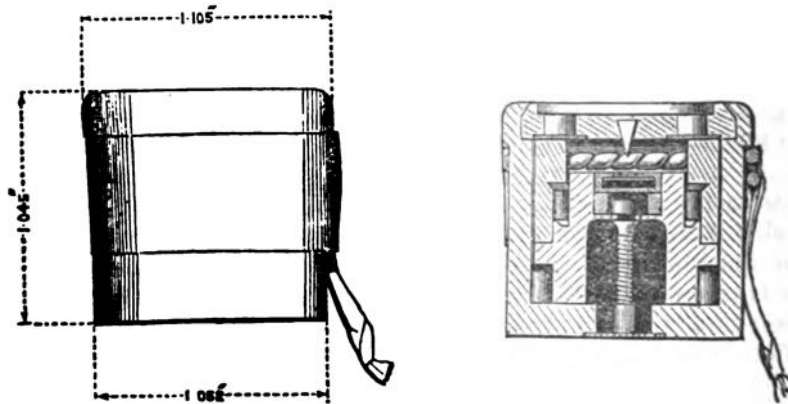

**Guard.**

The guard, consisting of a gun-metal collar pierced with two holes for the safety pin, fits inside next the top; it is recessed inside to receive the head of the pellet; there is a slight undercut at the top of the recess into which the pellet expands when the collar sets back.

**Pellet.**

The pellet is cast of equal parts of lead and tin; it is hollowed out and receives in its top the copper cap, which is primed with cap composition (fulminate of mercury, sulphide of antimony, and chlorate of potash), pressed and varnished in the same way as in gun caps. The composition is further protected by a very thin disc of brass; this has been found necessary to prevent premature explosions; a disc of paper coated with shellac is stuck on the top of the pellet covering the cap.

**Cap.**

The cap is pierced with three small holes, so arranged round the centre as not to interfere with the action of the needle; these holes allow the flash to pass down to the lower part of the pellet, which is filled with a pellet of mealed powder pierced like a tube and roughened so as to ensure ignition.

On the exterior of the pellet are four feathers or flanges, and below the pellet a disc of paper is placed to prevent its adhering to the bottom of the fuze.

**Bottom.**

The bottom consists of a gun-metal disc which screws into the base of the fuze; in the centre is a small recess which contains mealed powder driven and pierced as usual. This recess is closed on the exterior by a thin brass disc.

**Safety pin.**

The safety pin is made of twisted brass wire, and has a piece of tape attached to it to enable it to be withdrawn readily; a little beeswax is applied to seal the hole, and the tape is secured by a paper strip shellaced round the fuze.

Since 12/71 these fuzes have been painted with a black varnish § 2169. similar to that used with friction tubes in order to exclude damp as much as possible.

Remove the safety pin and drop the fuze into the shell, rim to the front ; replace the plug in the shell, except for naval service, when the E time fuze is used. **Preparation.**

When the safety pin is removed, the collar is supported by the feathers of the pellet ; on the shock of discharge the collar sets back, shearing off the feathers, and on striking the object, or on grazing, the pellet and collar fly forward, the cap comes in contact with the needle and explodes the fuze. **Action.**

This fuze may be depended on to act on graze even on wet boggy ground or on water, and will act at 400 yards where case ceases to be effective. It may be noted that short ranges are most trying to this class of fuze, as the graze then gives but a slight check to the velocity of the shell. Before the addition of the safety pin the feathers of the pellet were found apt to give way under the jolting to which the fuze was exposed in limber boxes ; but now the fuze is quite safe, as the pin takes the part of the lead feathers, which are only called into play when the pin is withdrawn.

In tin cylindrical box, holding two fuzes, each fuze in waterproof bag, 80 tin boxes, or 160 fuzes in a deal packing case. These fuzes will be issued in tin cylinders (15 in each) when the present store of cylinders is used up. **Issue.**

For field service 20 fuzes are carried on their sides in a tin axletree box.

#### *Fuze, Percussion, R.L., Mark I.*

Used with R.M.L. field service 7-pr. and 9-pr. common and Shrapnel shells. This fuze exactly resembles the B.L. percussion fuze in its internal arrangements. The body is of gun metal, both body and top are cast in one piece, the bottom is screwed in, a square hole in the head fits the G.S. key, by which it is screwed into the shell. This fuze fits the G.S. gauge.\* **§§ 2191, 2620.**



As the hole for the safety pin is exposed to the flash of the discharge, it has been found necessary to insert a lead pellet above the safety pin ; on ramming home, this pellet flies forward and closes the safety pin hole.

The safety pin is a plain brass wire with a brass wire ring which fits round the neck of the fuze ; the ring has a tape attached to it, and it is

\* A leather collar used to be issued on the fuze under the shoulder, but is now discontinued as it is an advantage to screw the fuze home as far as possible.

kept in its place by pasting a slip of paper over the tape. *The pin is not to be withdrawn until the shell is placed in the gun.*

Although the fuze as a general rule is not to be carried in the shell, still on going into action a certain amount of the shells might be carried fuzed with safety.

This fuze of course acts on graze in the same way as the B.L. percussion.\*

Five fuzes in a tin cylinder, each fuze wrapped in brown paper, and six cylinders packed in a deal case.

Issue.

§§ 2201, 2328.

For field service 16 fuzes are carried on their sides in a tin axletree box for the 9-pr., and 12 fuzes for the 7-pr.

### FUZE, PERCUSSION, R.L., MARK II.

§§ 2620, 2621.

It is intended for use in the L.S. with all B.L. shell having the G.S. fuze hole, and all R.M.L. shell up to the 80-pr. inclusive, and in the S.S. with 7 and 9-pr. R.M.L. shells only, with the exception in both services of 7-pr. double shell, as the small charge (4 oz.), used with these shell will not set it in action.

It can be used with common, segment, or Shrapnel shells, and will act either on graze or impact.

It is tapped with a screw thread to fit the G.S. gauge of fuze hole.

Its construction is given in the plate, page 328.

This fuze has been introduced because the R.L. fuze, Mark I., was found to fail when fired with heavy charges. The walls are made much stronger, entailing a reduction in the size of the interior parts of the fuze. The bottom is made with a deeper screw thread, enabling it to support the weight of the pellet and guard on the shock of discharge.

The head of the body is pierced to receive the safety pin. The lead plug serves to close the hole left when the safety pin is withdrawn. The safety pin is prevented from dropping out by bending the ends of its wire outwards as shown in the plate; the hole at this end of the pin is covered by a strip of metal soldered on. A loop of cord is attached to the safety pin in order that it may be withdrawn easily.

A needle point is fixed in the centre of the head above the cap in the pellet.

The guard is a gun-metal collar having two holes through which the safety pin passes, so as to keep it in position.

The pellet has a cap fixed in its head containing a large charge of percussion cap composition, (fulminate of mercury, sulphide of antimony, and chlorate of potash,) protected by a piece of very thin sheet brass. On the exterior of the pellet are two projecting "feathers," on which the guard is supported when the safety pin is withdrawn. There is no powder in the pellet.

---

\* The action of this fuze from the 7-pr. is uncertain, a considerable number of blinds have occurred.—Extracts, Vol. IX., p. 26.

It acts very well from the 9-pr. R.M.L.—Extracts, Vol. IX., pp. 57, 119.

The lowest charge that will cause it to act with certainty from the 9-pr. appears to be 10 oz.—Extracts, Vol. IX., p. 120.

Trials were made as to whether the fuze would act with safety without removing the safety pin, several blinds occurred when the safety pin was left in.—Extracts, Vol. IX., p. 297.

§ 2621.

† This fuze will replace Mark I. for the 7 and 9-prs. when the present stock of the latter is used up.

The bottom plug screws into the body, and has a central hole closed by a thin brass disc.\*

See page 55.

As above given for the B.L. plain. The lead plug prevents the flash of discharge from entering the fuze through the safety pin hole.

Same as Mark I. R.L. fuze.

The R.L. percussion fuze, Mark II., has acted well from the 9-pr., 16-pr., 40-pr., 64-pr., and 80-pr. R.M.L. guns, and also from the 40-pr. B.L. gun; if it was desired to use segment shell against troops in the field, this fuze would be invaluable.†

15 out of each 1,000 are selected, the "feathers" are cut off 10 of them, and the fuze dropped head down about four inches in an iron block; these should fire. The remaining 5 are fired, from 9 or 12 pr. B.L. gun, the R.L. screw from various up to the 80-pr., to see that they act on graze.‡

Preparation.

Action.

Issue.

Proof of  
B.L. and  
R.L. per-  
cussion fuzes,  
Marks I. and II.

\* The thickness of the disc has been reduced in those made since November 1873. The safety pin hole used to be covered with bees wax, and the bottom of the fuze painted, but in recent manufacture these operations are discontinued.

† See Extracts, Vol. XI., p. 67.

The Superintendent R.L. states the trials of the R.L. percussion fuze, Mark II., have been very satisfactory, that there appears to be no liability to premature explosions, that the fuze acts with at least as much certainty as any other percussion fuze yet tried under similar conditions, and that the rapidity of action is better than any yet tried.—Extracts, Vol. XI., p. 134.

Experiments have been carried out to ascertain whether this fuze would act when used in connexion with the lowest charge fired from the 8-inch R.M.L. howitzer, it failed to act when fired with 5 lb. or 6 lb. charges at an elevation of 10° but acted with charges of 7 lbs. and over. The initial velocity is probably too slow to cause the "guard" to set back when the small charges are used.

A recent trial at Shoeburyness (January, 1874) showed that the R.L., Mark II., fuze acted with the 7-inch B.L. gun; 25 were fired, 23 burst first graze, and two burst second graze. It is necessary to take out the safety pin before screwing the fuze into the shell.

‡ For Firemaster's proof, see p. 267.

## CHAPTER VI.—SHELL AND FUZE IMPLEMENTS. METHOD OF FILLING SHELL AND FIXING FUZES.

DISTRIBUTION OF IMPLEMENTS.—DISTRIBUTION OF SETS.—INSTRUCTION  
IN THE USE OF SHELL AND FUZE IMPLEMENTS.—WOOD BOTTOMS.

### DISTRIBUTION OF IMPLEMENTS.\*

Distribution of  
implements.  
§§ 1786, 1903,  
1910.

DESCRIPTION.	SETS, NUMBERS IN EACH.										Rifled Guns of Position.	
	Garrison Service.					Field Service.						
	1	2	3	4	5	1	2	3	4			
Bags { canvas { cylinders, { Common	-	-	-	-	2	-	2	-	-	-	-	2
{ wood { mortar	-	-	-	-	2	-	-	-	-	-	-	2
{ hook-borer -	-	-	-	-	2	-	2	-	-	-	-	2
Bits { hook-borer -	-	-	-	-	12	-	12	-	-	-	-	12
{ mortar -	-	-	-	-	12	-	-	-	-	-	-	-
Blocks, { 13-in. 1, 10-in. 1, 8-in. 1,	-	-	-	-	-	-	-	-	-	-	-	-
wood, { and 32-pr. 1, sets of	1	-	-	-	-	-	-	-	-	-	-	-
{ riveting, garrison -	-	-	1	-	-	-	-	-	-	-	-	-
Brace, mortar -	-	-	-	-	-	1	-	-	-	-	-	-
Cylinders, wood, { common	-	-	-	-	2	-	2	-	-	-	-	2
{ mortar	-	-	-	-	2	-	-	-	-	-	-	-
Drifts, wood, { common	-	-	-	1	-	-	-	-	1	1	-	-
{ diaphragm, { large	-	-	-	1	-	-	-	-	1	-	-	-
{ Shrapnel { small	-	-	-	1	-	-	-	-	1	1	-	-
Drivers, screw, { large	-	-	-	1	-	-	-	-	1	-	-	1
diaphragm, Shrapnel, { small	-	-	-	1	-	-	-	-	1	1	-	-
Extractors, fuze { large	-	1	-	-	-	-	-	-	-	-	-	-
{ small	-	-	-	-	1	-	1	-	-	-	-	1
Funnels, leather, { common { large	-	-	-	-	1	-	1	-	-	-	-	1
copper spouts { small	-	-	-	-	1	-	-	-	1	1	-	-
{ diaphragm, { large	-	-	-	1	-	-	-	-	1	-	-	-
{ Shrapnel { small	-	-	-	1	-	-	-	-	1	1	-	-
Gauges, fuze-hole { common	-	1	-	-	-	-	-	-	-	-	-	-
{ mortar	-	1	-	-	-	-	-	-	-	-	-	-
Hammer, riveting -	-	-	1	-	-	-	-	-	-	-	-	-
Handles, hook-borer -	-	-	-	-	2	-	2	-	-	-	-	2
Holder, shell, spherical -	-	-	1	-	-	-	-	-	-	-	-	-
Hooks, hook-borer -	-	-	-	-	2	-	2	-	-	-	-	2

\* The sets of fuze implements are retained for S. B. guns, and rifled guns of position. The fuze implements for other rifled guns will not be issued in sets. See Revised Army Regulations Vol. III., 1872.



DISTRIBUTION OF IMPLEMENTS—continued.

DESCRIPTION.	SETS, NUMBERS IN EACH.											
	Garrison Service.					Field Service.				Rifled Guns of Position.		
	1	2	3	4	5	1	2	3	4			
Keys, iron { common plug - - - - -	-	-	-	-	-	-	2	2	2	-	-	
{ plug and fuze, G.S. - - - - -	-	-	1	1	-	-	-	-	-	-	2	
{ square - - - - -	-	1	-	-	-	-	-	-	-	-	-	
Levers { common - - - - -	-	1	-	-	-	-	-	-	-	-	-	
{ mortar and naval - - - - -	-	1	-	-	-	-	-	-	-	-	-	
Mallets { common and diaphragm - - - - -	-	-	1	1	-	-	-	-	-	-	-	
{ mortar - - - - -	-	-	-	-	1	-	-	-	-	-	-	
Pricker, removing wax - - - - -	-	-	1	-	-	-	-	-	-	-	-	
Punch, iron, riveting top and bottom - - - - -	-	1	-	-	-	-	1	1	1	-	-	
Rectifiers { common { fuze-hole - - - - -	-	1	-	-	-	-	-	-	-	-	-	
or { rivet-hole - - - - -	-	-	1	-	-	-	-	-	-	-	-	
Rimers { mortar fuze-hole - - - - -	-	1	-	-	-	-	-	-	-	-	-	
Screws, coach, 4 in. by ½ in. - - - - -	-	4	-	-	-	-	-	-	-	-	-	
Setter, common and diaphragm - - - - -	-	-	-	1	-	-	-	-	-	-	-	
Spanner, or wrench-box - - - - -	-	-	1	-	-	-	-	-	-	-	-	
Tap, screw, Pettman, common - - - - -	-	1	-	-	-	-	-	-	-	-	-	

Holder, shell, Palliser, 12-in., 11-in., 10-in., 9-in., 8-in., &c. One per shell room for each nature supplied.

Wrench, removing plug - - - - - One per shell room.

Keys, iron, Armstrong shell and fuze. Two for each B.L. gun, using Armstrong time fuzes for S.S. only.

Funnels, copper, cartridge - - - - - Three per shell room for filling cartridges.

DISTRIBUTION OF SETS.

Description.	Proportion.	Distribution of sets.
No. 1 Garrison, S.B.— For rectifying fuze-hole of common, diaphragm Shrapnel and mortar shell.	One set to be retained at out-stations, or two at large stations, the large fuze extractor to be demanded separately.	
No. 2 Garrison, S.B.— For fixing wood bottoms.	One per shell room where spherical shell are prepared.	
No. 3 Garrison, R. and S.B.— For filling, securing and preparing common, diaphragm Shrapnel and rifle shell for firing.	One per shell room.	
No. 4 Garrison, S.B.— For preparing fuzes for common and diaphragm Shrapnel shell, and for service with 5½ and 4¾ mortars.	One set for every two guns in each district or station and twenty-five per cent. spare.	
No. 5 Garrison, S.B.— For filling mortar shell and preparing mortar fuzes.	One set for every two mortars in each district or station and twenty-five per cent. spare.	

35683.

D

DISTRIBUTION OF SETS—*continued.*

<i>Description.</i>	<i>Proportion.</i>
No. 1 Field, S.B.— For preparing common and diaphragm Shrapnel fuzes.	One set for each gun or how.
No. 2 Field, S.B.— For preparing shell.	One set for each gun, except 18-pr. gun.
No. 3 Field, S.B.— For preparing shell.	One set for each 32-pr. or 24-pr. howitzer.
No. 4 Field, S.B.— For preparing shell.	One set for each 12-pr. how. and 18-pr. gun.
Special Set.—Rifled guns of position and siege service.— For preparing shell and fuzes.	One set for each 64-pr. or 40-pr. B.L. gun.

## RECTIFYING FUZE-HOLES.

Instructions,  
No. 1 set.

*S.B. Shell, Common.*—Unscrew the metal plug from the fuze-hole by means of the square key and lever, [if the plug should be so firmly fixed in the shell that it cannot be unscrewed by the key, a few smart blows with the hammer will loosen it] insert the fuze-hole gauge—if the larger end of the cone is not flush with the exterior of the fuze-hole, place the shell in the holder, and fix it by screwing up the moveable jaw—the smaller natures of shell can be supported by hand in the proper position until the jaws have a firm hold; but for the 32-pr. and heavier natures a block of wood is necessary for the shell to rest upon; the jaws should grip the shell about half-way between the fuze-hole and the bottom—insert the rimer into the fuze-hole, and turn it *gently* round with the lever until the fuze-hole is the proper dimensions, *great care being taken not to make it too large*, then perfect the thread by means of the screw-tap. The shell-holder when in use must be screwed to a bench or table.

*S.B. Shell, Mortar.*—Remove the cork from the fuze-hole and insert the fuze-hole gauge. If the larger end of the cone is not flush with the exterior of the fuze-hole, place the shell, resting on a block of wood, in the holder, and proceed as above until the fuze-hole is the proper dimensions, *great care being taken not to make it too large*.

## FIXING WOOD BOTTOMS.

Instructions,  
No. 2 set.

*S.B. Shell, Common.*—Remove the bottom from the iron bar by unscrewing the nut at the end of the bar with the box spanner; place the shell on the wood block; remove the beeswax from the rivet-hole with the pricker; place a rivet in the rivet-hole of the wood bottom, with the point projecting beyond the concave surface; place it on the shell, moving it about until the rivet drops into the rivet-hole; place the punch on the head of the rivet and give it a few smart blows with the hammer.

If the rivet-hole in the wood bottom is rough and jagged pass the rectifier through it, turning it round so as to bring the hole to its proper form.

The common shell, which are issued loose, have the fuze-hole secured by a metal screw-plug, and are prepared with rivet-holes for fixing the

wood bottom. The wood bottoms are packed by twenties on iron rods and secured by an iron nut.

#### FILLING AND SECURING SHELL.

Remove the plug by means of the key, insert the funnel and pour in the powder, tap the shell with a mallet to ensure its being completely filled, leaving sufficient room for the fuze,\* carefully wipe every portion of powder from the fuze-hole, and in field service common shell drive in a papier mâché wad with the drift as far as the shoulder on the drift will allow, then screw in the fuze-hole plug. There is no special drift for B.L. field service common shell, any piece of stick larger than the wad will suffice.

Instructions,  
No. 3 set.  
Common shell,  
S.B. and rifle,  
and garrison  
segment,  
except 7"  
R.M.L.  
and over.

The wad secures the powder in the event of the plug working out.

The funnel is about  $2\frac{1}{2}$  inches larger in the cone than the naval shell funnel;—this is necessary to prevent the powder from being spilt, when shaking the shell, &c., during the operation of filling;—the spout is about 5 inches in length, so as to project beyond the neck of the bag into the interior of the shell, and thus give a free passage for the powder.

Filling shell,  
common and  
double, 7"  
R.M.L. and  
over.  
§ 2493.

The filling rod is of brass, 0.3 inch diameter and 3 feet in length, having a wooden handle at one end and a knob at the other end for tamping on the powder.

The funnel will supersede the naval shell funnel, except where funnels are issued for shells the bursting charges of which are not placed in bags; and the rod will supersede the "stick, burster bag, Palliser shells" (§ 2,122), which will become obsolete.

The funnels and rods will be issued in the following proportions, viz. :—

Naval service—1 funnel and 1 rod per ship for 7-inch guns and upwards.

Land service—1 funnel and 1 rod per shell-filling room for 7-inch guns and upwards.

The papier maché wad, G.S. (§ 2,075), is not required for shells having the bursting charge in serge bags.

The following instructions will be attended to in filling shells of the natures in question.

Place the filling rod in the bag, fold the latter tightly round the rod, insert it through the fuze hole, taking care not to force the end of the rod through the bottom of the bag. The bag must be carefully pushed in until the neck only is in the fuze hole, sufficient being, however, kept outside to retain a firm hold of, as the neck of the bag must not be allowed to slip into the shell during the operation of filling.

The rod will then be withdrawn, and the funnel inserted in the neck of the bag, projecting well down the fuze hole. The filling rod having then been passed through the funnel, two or three pounds of powder will be *gradually* poured in, the funnel and rod taken out, the bag lifted up and jerked, so as to "set" the powder well down to the bottom and to open the bag. The funnel and rod will be then re-inserted as before, and the filling continued.

The filling rod should be moved up and down to facilitate the passage of the powder through the funnel; the powder in the shell being pressed on at the same time.

\* When shells are filled in the R.L., a wooden plug of the size of the 9 seconds fuze is inserted to ensure sufficient room being left for the fuze; this is specially necessary for F.S. common shell.

§ 2540. When the shell is quite full, the funnel and filling rod will be withdrawn, and the neck of the bag tied with two half hitches of twine close to the top of the fuze hole. The superfluous choke will be cut off, and the neck of the bag pushed well down and to one side of the fuze hole. In cases where 7" double or common shell are to be fuzed with time fuzes,\* the shell must not be quite filled with powder, but sufficient space must be left for the insertion of the fuze after the choke of the bag is pushed in. The bag for the 10" shell, Mark I., does for Mark II. shell.

The shell can then be plugged or fuzed as required, taking care that both screws are free from powder or grit.

No preparation of the bag by pricking or otherwise is necessary when using either percussion or wood time fuzes.

Filled shells which have their bursting charges enclosed in serge bags will be marked "Filled, Bag" in red paint.

It is very important, particularly with the larger natures of shells, that they should be completely filled; they must be constantly struck with a heavy mallet except those with which bags are used from the commencement to the end of the operation. Great care must be taken to keep both the shells and mallets free from grit, to allow no loose powder to be spilled, and it is well to keep the floor damp.

Field service segment.

The field service segment shell, 20-pr. to 6-pr., carry iron bursters wrapped in brown paper, with the paper removed from the end which comes next the fuze. A wood plug covered with serge is placed over the burster before screwing in the fuze-hole plug.†

Diaphragm shrapnel S.B. guns.

Remove the plug from the loading-hole by means of the screwdriver—hold the shell in a position with the loading-hole upwards—insert the funnel and pour in the bursting charge—turn the shell from side to side to facilitate the filling—carefully wipe every portion of powder from the loading-hole, and drive in a papier mâché wad with the drift, as far as the shoulder on the drift will allow, and screw in the plug—unscrew the fuze-hole plug, to which is attached a wood plug covered with serge, to prevent the bursting powder from passing into the socket in sufficient quantity to cause inconvenience in fixing the fuze—and in order to insure the small hole communicating with the powder chamber being clear, shake a few grains of powder *from the powder chamber* into the socket—then replace the fuze-hole plug.

Shrapnel, rifled guns.

Unscrew the fuze-hole plug, and after seeing that the fuze-hole is clear of any dirt, &c., insert a common funnel and pour in the bursting charge. This must be done gradually, for if the whole of the powder is put in at once the tube will probably become choked. Shake the shell from side to side on its base, until the whole of the bursting charge has passed down the tube, taking care that none of the powder is left at the bottom of the fuze-hole. Drop in the metal primer, page 98, and by means of the large diaphragm Shrapnel screwdriver screw the primer tightly into the tube. Either Pistol or F.G. Powder is to be used.‡

§ 2286. Palliser shell, and Palliser shot when used as shell.

The shell or shot is to be set upon its point, which may be inserted in a block of wood hollowed for the purpose, or in any convenient place to steady it. No special pattern of block is necessary, it can be provided on the spot and the recess cut by any carpenter.

§ 1981.

\* This only applies to S.S., time fuzes not being used with the Woolwich guns in the L.S.

† A lead disc is inserted in the bottom of F.S. segment shell issued for L.S. A leather disc will answer equally well. See p. 104.

‡ R.F.G. may also be used.

The "Holder, Shell, Palliser," to be slipped over the base until it rests on the bottom studs, and then held firmly by one man while another applies the "wrench removing plug" to the plug and unscrews it.\*

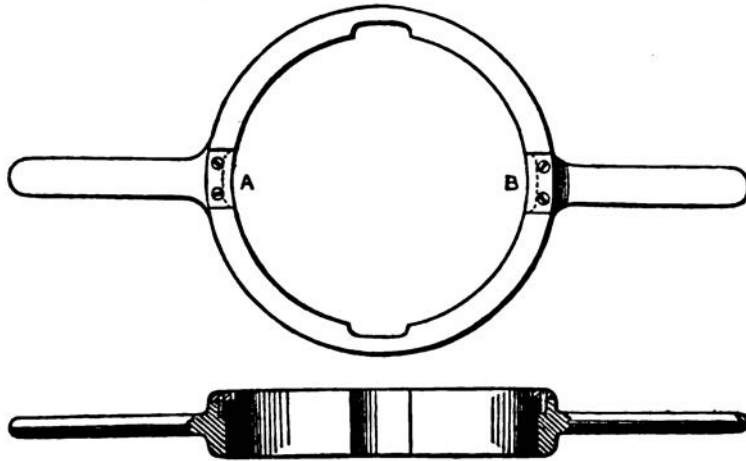

The serge bag for the Palliser shell (*vide* p. 163) will be stretched out as far as possible within the shell, the powder will then be inserted slowly, using a copper funnel which fits the bush closely and is long enough to protrude through the bush to the inside.

As much powder as possible will be inserted, leaving only sufficient space in the shell for the choke end of the bag and the plug to be screwed home, and in order to do this a brass rod will be used as directed for filling common shell. The choke end of the bag will then be tied and stuffed into the shell, leaving the tie so that it may be laid hold of when the plug is unscrewed.

Before replacing the plug any grains of powder or grit adhering to either screw must be carefully removed, &c., &c., &c.

When empty Palliser shells are kept at the guns, where the plug is liable to become set fast by corrosion from the action of salt water, the base plug should be unscrewed once every six months and the screw coated with a mixture of white lead and tallow.

#### PREPARING FUZES.

*Boxer Wood Time Fuzes for S.B. Shell, Common, and Diaphragm Shrapnel.*—The fuze is prepared for any desired time of flight by boring through the side hole corresponding to the required time into the composition. Instructions,  
No. 4 set.

Hold the hook borer by the handle in the right hand, place the fuze in the hook with the head of the fuze towards the body in the proper position for boring the required hole,† enter the bit into the side hole and work it forward by pressing hard upon the handle and turning it round at the same time, *until the screw takes the thread in the shank of the hook,*‡ then screw down to the shoulder; take care not to press upon the

\* There are six sizes of the Holder, Shell, Palliser, viz., 12", 11", 10", 9", 8", and 7". §§ 1696, 2412,  
1682, 1483.

† When using the hook borer with such a fuze as the small mortar or 20 seconds, great care must be taken to prevent the fuze turning to one side; if this is not attended to the bit may pass to one side of the composition, specially when boring near the small end of the cone.

‡ An obsolete form of hook borer may be met with where the screw thread continuous, thus rendering boring a slower process.



fuze so as to prevent its bedding fairly in the hook. Unscrew till the screw is relieved from the thread in the shank, then pull straight out, until the bit is clear, and remove the fuze. The length of the bit is so regulated that when placed in the handle it will enter sufficiently far into the composition when screwed down to the shoulder. If the bit should become unserviceable the handle must be detached from the shank and the tightening screw unscrewed, the square hole in the hook being made for this purpose. Care must be taken when substituting another bit that it is properly placed in the handle, *and that the tightening screw firmly presses upon it, for if any space be left between the handle and the head of the bit the end will not enter a sufficient depth into the composition.* The borer should be occasionally examined and cleaned. The operation of preparing the fuze and fixing it in the shell takes on an average about fifteen seconds; with a little practice these operations may be performed in a shorter time.\* Place the fuze in the fuze-hole of the shell, and give the head of the fuze two or three smart taps with the mallet and setter, or against the gun carriage if more convenient. Before the fuze is placed in the socket of the diaphragm shell care must be taken to remove any superfluous quantity of powder which may have passed into the socket through the communication hole. This is important, because the shell will burst prematurely if the powder in the socket prevent the fuze being securely fixed.

The fuze should not be uncapped until the shell is placed in the muzzle of the gun, this much reduces the chance of an accident and secures the priming from injury.

The papier mâché wad in the fuze-hole of common shell is driven into the shell in the operation of fixing the fuze.

*Boxer Wood Time Fuzes for Rifle Shell.*—The fuze is prepared for any desired time of flight by means of the hook or gimlet borer, p. 56, in the same way as the fuze for common and diaphragm shells.

§§ 2284, 2331.

The Boxer B.L. time fuze should be screwed very firmly into the fuze-hole by the hand, turning from left to right. A shell may be lifted by the fuze, which, if properly fixed, † will bear the weight of the shell. The safety pin must not be taken out until just before placing the shell in the gun. The M.L. fuzes may, if necessary, be set home with a mallet, or in the field service by a smart blow against a limber box; they should be fixed as firmly as possible. The papier mâché wad in F.S. common shell M.L. which are carried filled is driven into the shell in the operation of fixing the fuze.

The muzzle-loading fuze should not have the priming uncovered until the shell is placed in the bore of the gun. To uncover the priming, take hold of the small end of the copper band, which is left exposed, and unwind from left to right smartly, so as thoroughly to detach the band from the head of the fuze.

In firing against earth works or ships it is not necessary to prepare the fuzes for rifled ordnance to suit the particular range, as they have been found to act in such cases as a percussion fuze; that is, to cause the shell to burst immediately after striking. ‡

§ 2123.

\* The gimlet borer has been introduced for G.S. The point should be inserted into the required hole and the borer turned round without pressing on the handle until the shoulder rests against the fuze, care being taken to bore straight.

† Great care must be taken to fix B.L. fuzes firmly, if the shell is too full the fuzes cannot be *pressed* properly home, and occasionally fuzes have been found to fall out at practice, probably from the above cause.

‡ This action is not certain when the 20 seconds fuze is used.

*Armstrong E. Time Fuze.*—The fuze is prepared for the desired time of flight after it has been screwed into the shell.

Loosen the nut with the key, so as to free the collar. Hold the shell in the right hand and move the collar with the forefinger and thumb of the left hand, until the arrow points to the required length of fuze, then screw up the nut with the right hand, steadying the collar at the same time with the left hand. Finally tighten the nut very firmly with the key or by inserting it in the socket on the axletree box, giving the shell a slight turn towards the trail. Should the fuze be taken from the shell the collar must be set at the zero point before it is replaced in the box.

*B.L. plain and Royal Laboratory Screw Percussion Fuzes* require no preparation except the removal of the safety pin. The former is dropped into the shell over the burster, and the plug screwed in on the top of it; the latter is screwed into the shell; the papier mâché wads in common shell need not be removed, as in B.L. shell they are blown in by the action of the fuze, and in M.L. shell they are perforated to let the flash through.

*Pettman Percussion Fuzes.*—These fuzes require no preparation; they must be screwed into the fuze-hole right-handed by means of the key, fuze, and plug, G.S. The papier mâché wad in the fuze-hole of spherical common shell can be forced in by the handle of the key.

#### *Extracting Wood Fuzes.*

*Fuze for Common and Diaphragm Shrapnel.*—Clear out the cup of the fuze with the projecting piece of metal on the handle of the fuze extractor; take a firm hold of the head of the fuze between the jaws of the fuze extractor, and turn from left to right. The small knob between the jaws fits into the cup of the fuze and prevents the top from collapsing or giving way.\*

*Fuze for Rifled Ordnance.*—Apply the fuze extractor to the head of the fuze and unscrew.

#### *Filling Mortar Shell and preparing Mortar Fuzes.*

*Boxer Wood Time Fuzes for S.B. Shell, Mortar.*—Hold the fuze Instructions, firmly in the left hand; insert the point of the bit into the required hole; No. 5 set. place the head of the brace against the body and turn with the right hand until the stock comes in contact with the wood; reverse the motion until the bit is clear of the fuze.

The wooden bottom of the fuze must on no account be cut off, as it supports the composition, and prevents its being disarranged by the shock at the discharge.

Remove the cork from the fuze-hole, except in the case of the 10 inch Filling shell. and 13 inch, when it may be driven in; insert the funnel and pour in the bursting charge; insert the fuze, which has been previously prepared for the required range into the fuze-hole, and set it home by two or three smart taps with the mallet.

The cork must be taken out of the 8-inch as it might prevent the fuze being set home.

N.B. No. 1 set. Only a few sets kept at large stations.

Nos. 3 and 4 set, Garrison, are used both for S.B. and rifle shell.

The boxes for fuze implements are painted red.

---

\* An obsolete form of extractor may still be met with, it was made for the old fuzes and the jaws do not open wide enough to take the present fuzes.

F.S. Sets S.B. The difference of size in the loading holes of Shrapnel shell entails having different sets enumerated for field service, the filling holes are small up to the 18-pr. inclusive. Also calibres of 12-pr. and upwards require implements for filling common shell.

Gimlet borer.  
§ 2123.

A *gimlet borer* is issued to field batteries. Mark II. has a stronger and larger handle than Mark I. as well as a spiral blade. It is now issued for general service.

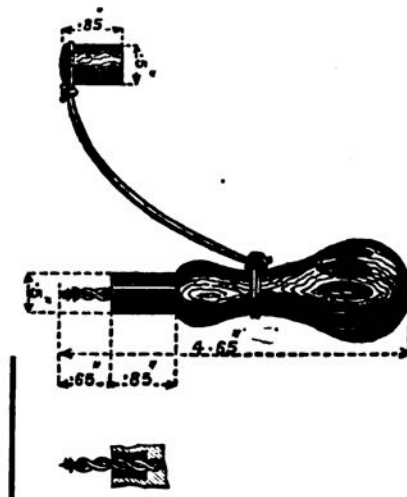

Key, iron, plug, and fuze, G.S. § 1308. *Key, iron, plug, and fuze, general service.* One arm, *b*, intended for pillar fuzes, is used for the G.S. plug and adapters, the other arms, *a* and *c*, are used for the common gauge plug, and Pettman's L.S. and Cl. 91, A.C./73. G.S. fuzes.

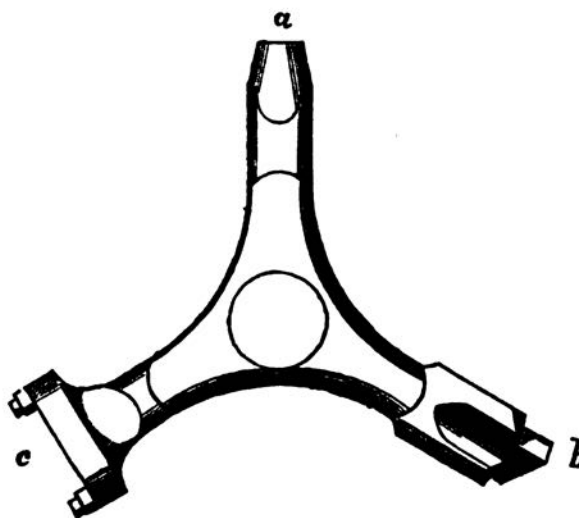

Key, plug, G.S. § 1992. *Key, plug, general service,* is simply for screwing or unscrewing G.S. plugs and R.L. percussion fuzes.

Key, Armstrong, Universal, § 1683. There is also a *key, Armstrong, Universal,* for use with the Armstrong E. time fuze, but this is only now issued for S.S.

Key, common plug. A *key, common plug,* is issued in the sets for S.B. guns.

Drift, wood, G.S., § 2045. A *G.S. drift* is issued to insert the wad in the common shell for rifled guns.

WAD, G.S.

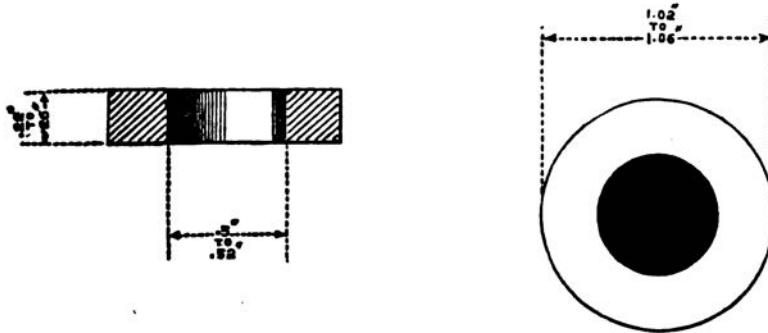
Wad, G.S.  
§§ 2075, 2527,  
2627.

The *G.S. wad*, Mark II., serves to prevent the powder from working up in the fuze hole of common shell. It is made of papier mâché, and has a hole in the centre covered by shalloon cemented to one side. This wad is forced in by fixing the time fuze, and does not require removing when the percussion fuze is used. The side covered with shalloon is placed downwards in the shell. Its use is confined to field, boat and siege service.

*Copper scrapers* are used in removing any powder from filled shells. Copper In future the sizes will be manufactured, large, for rifled B.L. and M.L. scrapers, §2174. shells 7" and upwards, and for S.B. 13". Small, for R.B.L. and M.L. 9-pr. to 64-pr. S.B. 12-pr. to 10-inch. These scrapers will supersede those at present in use for S.B. shells when the store is used up.

One *miner's powder horn* issued per battery ; it contains 1½ lbs. of Powder horns. F.G. powder, used for priming guns if required.

A *buff leather pocket* or pouch to hold 5 Boxer fuzes is issued for Pockets, buff, F.S. It is fitted with a strap to fasten round the waist. It also carries § 1994. a gimlet borer.

CHAPTER VII.—MONOGRAMS OF STATIONS.  
 CASES AND BARRELS USED FOR FILLED  
 CARTRIDGES AND GUNPOWDER. HINTS  
 ON COOPERING.

*Monograms of Stations.*

§§ 1633, 2294. To enable the place where cartridges, shells, &c. are filled to be traced, each station where there is a Laboratory, &c. has a monogram.

HOME STATIONS.

ALDERNEY - - -	A.	GOSPORT - - -	G.
CHATHAM - - -	C.	HARWICH - - -	H.
CHESTER - - -	<del>H</del> C.	GUERNSEY - - -	<del>G</del> .
CORK - - -	<del>S</del> C.	JERSEY - - -	J.
DEVONPORT - - -	D.	PEMBROKE - - -	P.
DOVER - - -	<del>V</del> D.	SHEERNESS - - -	S.
DUBLIN - - -	<del>E</del> D.	TYNEMOUTH - - -	T.
EDINBURGH - - -	E.	UPNOR - - -	U.
FORT GEORGE - - -	<del>G</del> .	WOOLWICH - - -	W.

FOREIGN STATIONS.

BARBADOES - - -	B.	HALIFAX - - -	H.
BERMUDA - - -	B.	HONG KONG - - -	H.K.
CAPE TOWN - - -	<del>C</del> .	MALTA - - -	M.
CEYLON - - -	<del>C</del> .	MAURITIUS - - -	<del>M</del> <sup>S</sup> .
GIBRALTAR - - -	GIB.		

*Cases and Barrels.*

As the same case may serve for cartridges for rifled and S.B. guns it will be convenient to enumerate them all here.\*

1. Metal lined cases.
2. Pentagon cases.
3. Brass rectangular cases, plain.
4. " " " corrugated.
5. Gun ammunition barrels.
6. Boxes.
7. Zinc cylinders.
8. Powder barrels.

\* Dell's case is obsolete, for disposal see C. 75, A.C., 1869.



For capacity and weights of various cases, see tables, pages 184, 300.

A luting of equal parts of tallow and beeswax is used on the lid of Luting. the metal lined and metal cases to exclude the air as much as possible, and should always be carefully applied in magazines.

\* *Metal lined cases* are of three sizes,—whole, half, and quarter ; they are rectangular cases of deal, the corners of oak, and the cleats of ash, lined with copper. Their dimensions are:—whole 17" × 20½". Half 13½" × 16½". Quarter 10½" × 14".

1. Metal lined case.

A square lid opens on hinges on top of the case ; it is screwed down by two gun-metal bolts by means of a gun-metal key ; the door covers a circular opening which is closed by a bung of tinned copper ; the bung is luted into its place when the case is full.

The whole size will take all S.B. cartridges, and rifle cartridges up to the 9" inclusive, except "P" powder ; the two smaller sizes are generally used by the navy for small combustible stores, and blank S.A. cartridges.

Metal lined cases are used in magazines which are not very dry, sailing vessels, and siege trains.

The half case holds 2,400 blank, or 1,440 ball, Snider cartridges, quarter case holds 1,020 blank or 560 ball.

When filled at Woolwich a paper label is pasted across the edge of the lid immediately under the ring, having the packer's name and date of issue. On the side of the case is stencilled the tare and gross weight, the lid is marked with the nature and number of cartridges, the station intended for, and date of their manufacture. Similar information would be given with the other cases.

§ 2290.

*Pentagon case* of 2 sizes, whole and half. The lid hinges on a curved bolt ; there are slots in the projecting rim of the lid and corresponding projections on the neck of the case ; the lid will only open when the slots and projections are in a corresponding position. The dimensions of the whole size case are, 19.3" × 15.5" × 11".

2. Pentagon case. § 2483.

Suppose the lid to be closed. To open it, first with the spanner unscrew the bolt which presses on the curved bolt, then place the curved projection on the lever into the eye of the curved bolt, the other projection bearing against the lid, and turn from left to right ; the lid of the case will then be opened. To close the lid, you turn from right to left.

There is a second socket furnished for the bolt in case the other should get broken. The body of the case is made of sheet brass, the top and fittings of cast brass.

The whole takes all S.B. cartridges, and rifled up to 8" inclusive, ("P" powder excepted), and also the smaller charges for the 9' R.M.L. gun.

The half case is produced by taking a section of the pentagon along a line bisecting the long side of the head and perpendicular to it. It has four sides, and is used by the navy for convenience in stowage, generally used for small stores.

The shape enables the pentagon case to pack well in a ship's magazine. These cases were introduced for naval use.

*Brass Rectangular Case* is made of sheet brass, cast brass top and fittings. It opens on the same principle as the pentagon. The head working on the curved bolt is a ring in this case. It has two holes which take the projections on the lever.

3. Brass rectangular case, plain. § 975.

\* Bags, calico, metal-lined, or pentagon cases (Mark I.), L.S., § 2431. When powder, not made up in cartridges or bags, is stored in these cases the calico bag will be used.

The case will take all S.B. cartridges and rifle cartridges up to the 9" inclusive, "P" powder excepted. It was specially made for the 100-pr. and 150-pr. No more will be made. The dimensions are, 22"  $\times$  18 $\frac{1}{4}$ "  $\times$  11".

4. Brass rectangular corrugated case.

*Brass Rectangular Case, Corrugated.*—Made of corrugated sheet brass, with cast brass top and fittings. The corrugations strengthen the case. These cases are used for S.S. only.

Powder Case, Corrugated Metal, Rectangular. "A." Mark II.

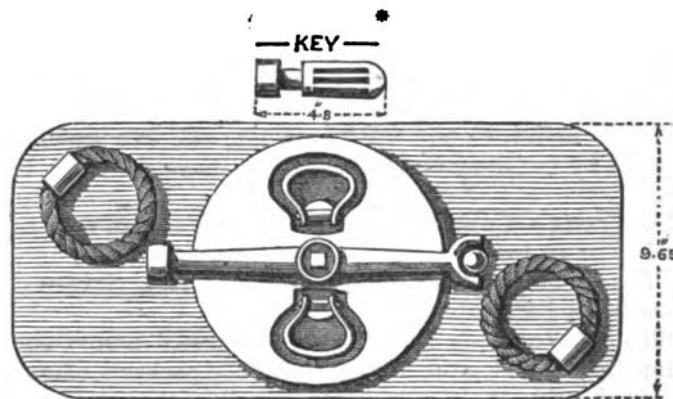

Top view.

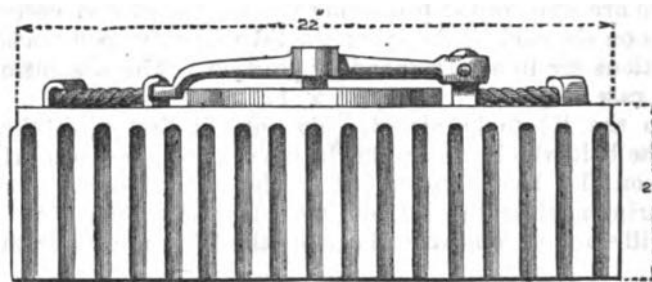

Side view.

$\frac{1}{2}$ th full size.

§ 2538.

\* Mark II. Key made of gun metal, with a cross handle bevelled off at one end for the purpose of extracting the ring handles of the lid of the case if they should become fixed in the recess.



It is opened by unscrewing the central screw bolt and pulling the bar to one side, thus allowing the lid to be lifted off.

There are four sizes, known as A., B., C., and D. § 1909.

"A." I. and II. takes 7", 8", and 9" R.M.L. cartridges. Dimensions, § 1402.  
22" × 23" × 10".\*

"B." takes 10" R.M.L. cartridges; either two battering, or three § 1700.  
full charges of pebble. 26" × 20" × 11".

"C." takes 12" 25 ton R.M.L. cartridges; either two battering, or § 1771.  
three full charges of pebble. 22" × 24" × 13".

"D." will take 110 lbs. charges of P. powder; either two battering, § 2208.  
or three full charges of pebble for the 12" 35-ton gun. 24" × 32" × 13".

They will take all S.B. cartridges.

*Gun Ammunition Barrel.*—Of two sizes, whole and half; full bound; 5. Gun ammu-  
four copper hoops; staves of oak, or teak for tropical climates. The nition barrel.  
lid is generally teak, and has a circular opening, into which a wooden § 774.   
lid fits, working on a hinge and secured by a screw bolt. A gun-metal  
key is used to screw or unscrew the bolt. The whole size will contain  
all S.B. cartridges.

These barrels are the same size as powder barrels,† but are not intended to contain loose powder. They are used in dry magazines to contain cartridges. No luting is used to close the lid.

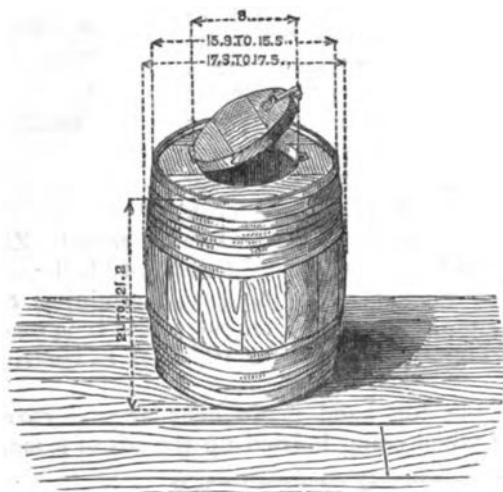

*Ammunition Boxes* are used for the issue of cartridges to field 6. Ammunition  
batteries at home. They are marked with the nature and number of box.  
cartridges.

\* Mark I. "A." corrugated case opens in the same way as the plain rectangular § 1369.  
case, the neck and lid projects beyond the sides, entailing the necessity of placing  
battens between the cases, thus causing loss in the magazine. On return to Woolwich  
they are altered to Mark II. before re-issue.

N.B.—The B., C., and D. cases have their opening at one end instead of the  
centre.

† The hooping is not in accordance with recent changes.

7. Zinc cylinders.  
§ 2171.

*Zinc Cylinders.* See table p. 63, for dimensions, &c., are used in the L.S. to contain the cartridges of the Woolwich guns. Each cylinder holds one cartridge; the 7-inch, Mark II., will hold two 14 lb. charges, or one battering charge. They not only act as cases in the magazine, but also serve to bring the cartridge up to the gun. Their construction will be understood from the sketch. The 12" 25 ton or 11" are not to be stacked more than three deep, the 10" four deep, the 9" and under five deep.

§§ 2437, 2469.

None have yet been sealed for the 8" and 12" 35 ton guns, which were introduced for S.S.

The 9", 10", 11", and 12-inch 25 ton guns have each two cylinders, one for the battering, and one for the full charge; those of recent manufacture will contain either pebble or R.L.G. cartridges.

A hook fastening has replaced the slot which was not sufficiently strong, and to avoid a difficulty found in opening these latter in the ordinary manner, the latest pattern, Mark II., has the interior of the lid fitted for a felt ring saturated with beeswax,\* which is to be inserted when the cylinders are packed with cartridges. Metal straps are to be issued to stations having Mark I. cylinders, with bayonet fastenings. By tightening up the straps by means of screws, one strap to the lid and another to the bottom of the cylinder, a good hold is obtained, and the lid can be twisted round. Zinc cylinders are

§ 2173.

in future to be painted stone colour inside and out like brass powder cases.†

Cage metal,  
§ 2218.

*Cage metal* for raising zinc cylinders, containing cartridges when being hoisted up powder lifts of magazines. It is made of brass and will carry any cylinder up to that for 12" R.M.L. cartridge. Its weight is about 14½ lbs.

§ 2475.

Mark II. has the top band made broader and carried inwards to prevent jamming when being hoisted up the lift of a magazine.

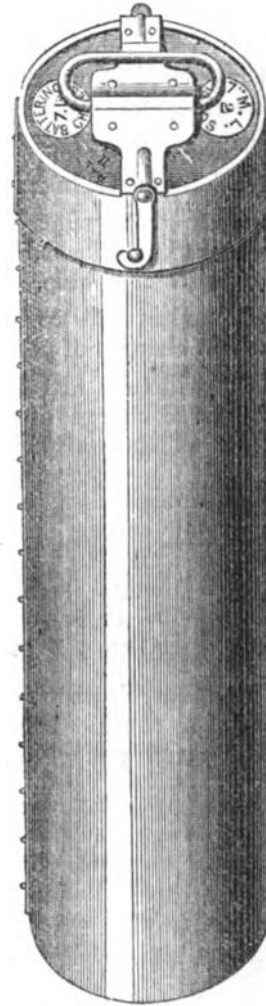

Scale 2 ins.—1 foot.

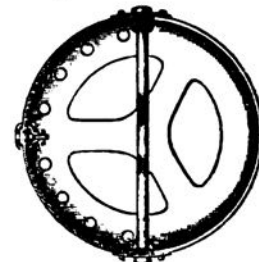
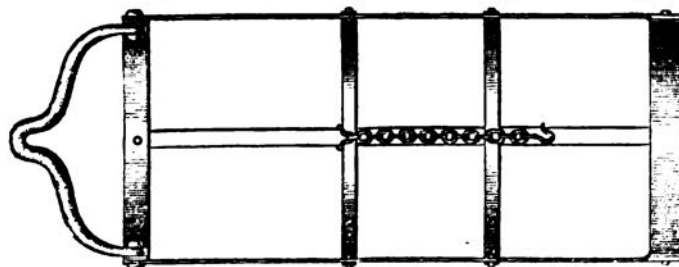

§§ 2293, 2548. A 2" white rope about 30 feet in length with a hook at one end and a counterweight zinc ball 1½ lb. weight fixed above the hook, is approved for use with the above.

\* If the felt strip is not supplied, tow or wool, saturated with beeswax, is to be used.

† When zinc cylinders are used in cartridge filling rooms enough wadmiltits must be demanded to cover the whole.—Revised Equipment, p. 19.

Details of Patterns of Zinc Cylinders.

Nature of Cartridge, and Numeral of Case.	Date of Approval.	Changes in War Stores.	Length.	Diameter.	Marks on Cylinder.	Remarks.
12" 25 ton I. { 1 Battering, 85 lbs. P., or 67 lbs. R.L.G. 1 Full, 55 lbs. P., or 50 lbs. R.L.G. }	8/71 12/71	2172 2185	inches. 22.1 15.1	inches. 12.0 12.0	Battering charge, 12" M.L., R. ↑ L. I. Full " " " " " " " " " " " "	Vide §2437, Changes in War Stores, for directions as to painting, packing, and securing.
11" I. { 1 Battering, 85 lbs. P., or 70 lbs. R.L.G. - } 1 Full, 60 lbs. P., or 50 lbs. R.L.G. - }	4/72	2270 {	26.5 19.5	11.0 11.0	Battering " 11" " " " " " " " " " " Full " 11" " " " " " " " " " "	
10" II.* { 1 Battering, 70 lbs. P., or 60 lbs. R.L.G. - } 1 Full 44 lbs. P., or 40 lbs. R.L.G. - }	23/12/71	2185 {	26.0 18.1	9.8 9.8	Battering " 10" M.L. II. Full " 10" " " " " " " " " " "	
9" to contain 1 43 lbs. R.L.G., cartridge I. - - } 9" " 1 30 lbs. R.L.G., " I. - - }	Provisionally 23/5/66	1269 {	26.196 17.196	8.65 8.65	9" M.L. 30 lb. I., W. ↑ D.	
9" II. { 1 Battering, 50 lbs. P., or 43 lbs. R.L.G. - } 1 Full, 30 lbs. R.L.G. - - }	22/9/71	2171 {	23.0 17.0	8.75 8.5	Battering charge, 9" M.L., R. ↑ L. II. 9" M.L. 30 lbs., R. ↑ L. II.	
9" III. 1 Full, 30 lbs. R.L.G. - - }	8/7/72	2295	17.0	8.75	9" " " " " " " " " " " "	
7" to contain 1 22 lb. R.L.G. cartridge I. - - }	Provisionally 23/5/66	1269	19.696	6.75		
7" " 2 14 lb. R.L.G. cartridges I. - - }	Provisionally 23/5/66	1269	27.196	6.75	7" M.L. 2 14 lbs. I., W. ↑ D.	
7" II. { 1 Battering, 30 lbs. P., or 22 lbs. R.L.G., or } 2 Full, 14 lbs. R.L.G. - - }	22/9/71	2171	27.0	6.65	{ Battering charge, 7" M.L., also 7" M.L. 2, 14 lbs., R. ↑ L. II.	

The cylinders approved 6/67 and 9/67 for 13" cartridges are now obsolete.

\*10" I. { 1 60 lb. cartridge, R.L.G. } several of these have been issued, vide §2185.  
" " " " " " " " " " " "



Powder barrels.  
§§ 1884, 2553.

*Powder Barrels* used to be full bound with twelve ash and four copper hoops.

Machine made barrels are now issued with six ash hoops, they were for some time issued with four, but six are considered to be preferable. The ash hoops protect the barrel by keeping the bilge off the ground, and also keep the copper hoops from slipping. They are of three sizes, whole, half, and quarter, and are used to contain loose powder, and occasionally to hold gun ammunition; they hold respectively 100 lbs., 50 lbs., and 25 lbs. of powder.\*

When powder is sent by rail it is put in a flannel bag and placed in a half or quarter barrel. The barrel is covered by a canvas bag and placed in an iron case or cylinder. These iron cases are only made of two sizes, whole and half; any other combustible stores are sent in the same manner. B.L. small arm cartridges may be sent without being placed in iron cases, as they are very difficult to ignite in any way, and will not explode in mass under any circumstances.

Budge barrels.

*Budge Barrels*.—A quarter powder barrel with only one head, the other being replaced by a leather powder bag, the mouth of which is closed by a leather thong. Used for holding loose powder for mortars.

Small arm cartridge barrels.

*Small Arm Cartridge Barrels* are of three sizes, half, quarter, and eighth; they have no copper hoops, and are used for conveyance and storage of S.A. ammunition. The half size is used for blank cartridges, 2,000 rounds (the weight would be inconveniently great with ball cartridge), the quarter size for ball, 700 rounds of Snider arm, or Martini-Henry cartridges, and the eighth for small supplies.

For ball cartridge they are being superseded by boxes, but are still in use for home service.

Box, wood, S.A. ammunition.  
Mark IV.  
§§ 2175, 1991, 1877.

*Box, wood, S.A. Ammunition, Mark IV.*, with sliding lid, made of teak† or mahogany, lined with tin for foreign countries, and at present of deal unlined for home service; but it is intended to line all the boxes with tin when the present store of unlined boxes is used up; they hold 560 rounds of Snider cartridge, pattern IX., or 600 rounds of the Martini-Henry cartridge. The box weighs about 70 lbs. when packed with Snider cartridges, and 78 lbs. with Martini-Henry cartridges. The inner lid of tin is soldered to the tin lining.‡ A handle is attached to one corner by which the plate can be torn off.

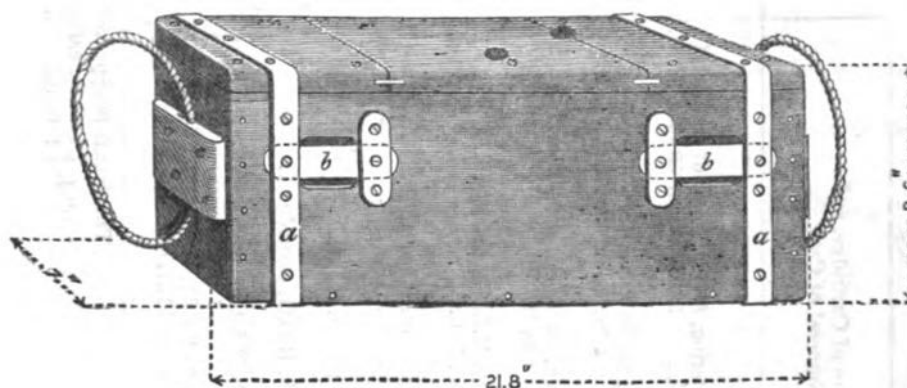

Camel box.  
Bullock box.  
§ 1990.

*Camel boxes* for India hold 2,400 rounds Snider cartridges.

*Bullock boxes* for India, 780 rounds.

*Box, wood, S.A. ammunition, mark II.*, for Adam's pistol, lined with tin, holds 600 rounds.

§§ 1616, 1866.

\* The whole barrel holds 125 lbs. of "P" powder owing to its greater density.

† Deal has recently been used for the sides and bottoms.

‡ The early patterns of S.A. ammunition box are smaller. Mark III. differs from IV. only in minor details.

*Cylinders, Iron*, for conveyance of ammunition by rail are cylindrical in form. There are two sizes, to hold half and quarter powder or ammunition barrels. Cylinders, iron.

*Bags for Cylinders* :—

- (a.) Canvas to contain the case.  
(b.) Flannel to contain the powder.

Bags for cases.

All cannon cartridges which are not contained in metal or metal-lined cases, or which are intended for field or boat service, are placed in brown paper bags, the barrel or box in which they are packed being also lined with brown paper. In field batteries the bag would to some extent preserve the cartridge from wearing out; they are also stated to preserve the cartridge from damp. Bags for can-  
non cartridges.  
§ 1874.

Waterproof bags may be specially demanded; they are made of two thicknesses of fine white paper cemented together by india-rubber dissolved in naphtha.

Waterproof covers for cartridges 12", 10", 9", 8", and 7" R.M.L. guns, are provided for the navy; they are bags of fine cambric, waterproofed by vulcanized india-rubber attached on one side (not made in the R.L.) § 2048.  
§ 2439.

As shells are now filled bursters do not require to be made up. before stated Shrapnel are filled by measure or weight to ensure their having the full charge, as less would fail to open the shell. Shells issued to field batteries would be issued empty, except in first equipments. Bursters made up in paper bags enclosed in calico are, however, still retained for S.B. field batteries; this applies to 6-pr., 9-pr., 12-pr., 18-pr., and 24-pr. S.B. diaphragm Shrapnel shells. §§ 954, 1581,  
1686.

*Leather Cases for Cartridges* are of nine sizes, viz.\* :—

- No. 1. For 13" mortar, 10" mortar, and 10" guns.  
No. 2. For 7" B.L., 68-pr., 56-pr., and 42-pr. guns. Leather cases.  
No. 3. For 8" guns.  
No. 4. For 64-pr. and 80-pr. M.L., or 40-pr. B.L., and 32-pr. guns, down to 56 cwt. § 1021.  
No. 5. For 32-pr. guns, 32 cwt., 24-pr. guns of 50 and 48 cwt.  
No. 6. For 8" and 5½" mortars.  
No. 7. For 20-pr. B.L. and 18-pr. and smaller S.B. guns.  
A. For 7" R.M.L. S.S.  
C. For 9" R.M.L. S.S.

The case is a leather cylinder with lid, which slides up the handle, and is used to bring cartridges up to the gun from the magazine; it is not uncovered till the sponge is out of the bore.

*Cases of Clarkson's material for Cartridges* are of six sizes, viz. :— §§ 1798, 2076.

- A. For 7" R.M.L. S.S.  
B. " 8" " "  
C. " 9" " "  
D. " 10" " "  
E. " 12" " 25 ton S.S.  
F. " " " 35 ton S.S.

*Leather Hides* are used to cover the floors of magazines. Wadmill-tilts are also used for the same purpose, in order to diminish accidents from grit or sand. Cloths, hair, are provided in revised equipment. Leather hides.  
Wadmilltilts.  
Hair cloths.

N.B.—It may be mentioned here that no one is allowed to enter a magazine without putting on leather slippers, which are kept for the purpose.

\* Cases are not required in the L.S. for 7" M.L.B. guns and upwards, as the cartridges are brought to the gun in zinc cylinders.

When men are much employed in magazines they should be made to change their clothes on entering them, to avoid risk from their having matches, &c. in their possession.

*Hints on Coopering.*

The following *hints on coopering* are introduced as likely to be useful. Powder barrels consist of three parts, viz. :—

1. Staves.
2. Heads.
3. Hoops.

1. Staves. The most protuberant part of the barrel is known as the "bilge," and the centre of the bilge is distinguished as the "pitch." Between the bilge and the end of the barrel is the "quarter." The extreme end is known as the "chime." To distinguish one end of the barrel from the other, that which is opened (when required) is known as the "top end," the other as the "back end." The top end may be known by having the staves bevelled off close to the chime to facilitate heading. There are thus also the "top" and "back bilge," the "top" and "back quarter," the "top" and "back chime."
2. Heads. The heads are known as the "top heads" and "back heads" respectively. When a head is in three parts, the "dowels" having been broken or pulled asunder, the two outside pieces are known as the "cants" or "outsides"; the other part is known as the "middle" piece.
3. Hoops. Barrels used to be either "full bound" or "quarter bound," according to the number of hoops. All powder barrels, either full or quarter bound, have four copper hoops, the remainder ash. These hoops are situated about the chime and round the bilge of the barrel, and are known as the "copper chime" and "bilge hoops." On the "full bound" barrel there were also six ash hoops at each end, situated one below the copper bilge hoop; four at the quarters and one above the copper chime hoops.
- § 2553. Powder barrels are now made with four copper and six ash hoops, each copper bilge hoop has an ash hoop on each side of it, the copper chime hoops have ash hoops outside them. The wood hoops protect the barrel, which would otherwise rest on the bilge, they also keep the copper hoops from slipping.
- To unhead a barrel.  
First method. A barrel can be unheaded in two ways. The first and more common method is to place the barrel with the top end uppermost, and then to remove the top chime hoops and loosen the top quarter hoops. The left hand is then pressed upon the middle piece of the head, which is struck gently with the adze or mallet close to the chime on the side nearest the cooper, until it is started out of the groove and falls into the barrel.
- Second method, or "boxing." The second method is called "boxing out" the head, and is adopted when the groove is deeper than usual, or when from other causes, such as the barrel being incorrectly made and having too sharp a curve, the head cannot be readily removed by the first method. The hoops are loosened and removed as before, and the left hand placed upon the head, and a few smart blows are struck with the mallet round the pitch of the barrel, by which means the staves are, as it were, sprung back, and the head being thus released falls through.
- Heading a barrel—head whole. To head a barrel.—The head, if whole, is placed with its bevelled edge (on the side away from the cooper) in the groove, the left hand is then placed upon it, and the head slightly struck, as much as possible in the direction *away* from the workman, with the adze or mallet; in this manner it is driven into the groove all round. The chime hoops are

then replaced. If on heading a barrel the head should accidentally be driven a little below the groove, it can generally be jarred back into its place by laying the barrel on its side and tapping the top end of the staves.\*

When the head is in two pieces, the dowels (if still adhering) must be cut away. The larger piece is then placed with the whole of the left front in the groove to the left hand side, away from the workman. The small piece is then placed alongside the larger, its further edge also entering the groove; the left hand is then placed over the junction, and by means of a few gentle blows, given with care and at the spots where they may seem to be most required, the head is driven into the groove.

If the head is in three the dowels must be cut off and the pieces matched according to the lettering on the head. One of the "cants" or "outsides" is then placed as the larger piece in the last case, and supported by the left thumb, which is brought over the side. The middle piece is then placed against it, its further edge in the groove, and its straight edge pressing hard against the side of the "cant." The other cant is then placed in the groove; and proceed as when the head is in two pieces.

Sometimes when the barrel is headed the head will be found to be a little out of round or injured at the edge, thus leaving an opening between the head and staves. It then becomes necessary to use the "flagging tool." One of its teeth is pressed against the inside of the stave where the opening appears, and the other tooth outside the stave to the right. By pressing against the handle, and using it as a lever, the opening is widened, and a little "Dutch rush" or "flag" (if not procurable, paper or rag will serve) is placed inside the gap; the flagging tool is then removed, and the stave being released springs back into its place, pinching in the rush against the head.

To avoid using a knife (*which should never be allowed to enter a magazine*) the rush should be placed as much as possible flush with the top of the head of the barrel.

If the ash hoops are too large they may be reduced in diameter to the required size by placing a small three sided prism or wedge of wood, called a "Dutchman," between the shoulders or notches of the hoop. If the hoop is too small it may be enlarged by cutting away part of the shoulders.

Before taking a barrel to pieces for stowage (called "shaking" a barrel) the staves must be numbered round the inside with a piece of chalk or a pointed tool.† The hoops are then removed and laid aside. The ash hoops (if the barrel is to be sent away) are seldom packed with it; the copper hoops are doubled up. The head is divided into two or three pieces by pulling open the joints without breaking the dowels.

The staves are then packed round the copper hoops and the "ends," and the pack secured with twine or with some of the wooden hoops.

To put the barrel together again the pack is untied and the copper hoops unbent. One of the copper chime hoops is then taken in the left hand and held at about the height of the barrel from the ground, the cooper kneeling on his right knee. The staves, as numbered, and with their top ends uppermost, are then arranged round the inside of the

\* It is forbidden to use nails in re-heading a barrel; sometimes copper nails have been used, but these are objectionable even when the barrel is empty, as in unheading they are apt to get into the barrel and so find their way to the powder when the barrel is refilled.

† This need only be done with hand made barrels; with machine made barrels it is not necessary.



hoop, their lower ends resting upon the ground, the first few staves as they are arranged being supported by the outside of the left leg and left foot. In this manner the barrel may be built up, when the upper bilge hoop is slipped on. The barrel is then turned round and the other bilge hoop slipped on. The head is then put together and the back head is placed into the barrel (working chiefly from the inside); the back chime hoop is then placed on. The barrel is then headed up, the top chime hoop being previously removed to admit of this being done; the chime hoop is then put on again.

To remove a stave without "shaking" the barrel down.

Heading and unheading vats.

All the hoops, except the bottom chime hoop and the top bilge hoop, must be removed; remove the required stave and replace it by another, and then replace the hoops.

The heads of vats (chiefly used for the conveyance of clothing, harness, &c.) are secured by means of two hoops nailed round the inside of the chime of the vat, the head being between them.

To unhead a vat thus secured the "outside lining hoop" (as the hoop above the head is called) must be removed, and this is done by "prising" out the nails with a chisel or lever of any convenient sort, commencing at the "lap" of the hoop.

To head the vat.—The head is laid upon the inside lining hoop, and the outside lining hoop is nailed over it.

---

## CHAPTER VIII.—FRICTION TUBES, COPPER AND QUILL. LANYARDS. COMMON QUILL AND PAPER TUBES. ELECTRIC TUBES, FUZES, AND DETONATORS. PORTFIRES AND LIGHTS. QUICK AND SLOW MATCH. BICKFORD'S FUZES.

---

**Friction tubes.**

Friction tubes are one of the most important stores manufactured in the R.L.; their action when new is very certain, their keeping qualities are however not equally satisfactory. Experience has shown that tubes about 10 years old should be regarded with suspicion.\*

Both copper and quill friction tubes are manufactured, the latter exclusively for the navy, as copper is found dangerous where men work with bare feet, and also the copper tube rebounding from the beams of the deck is apt to cut men's faces, probably this inconvenience will be found troublesome in casemated batteries. The quill tube, requiring a support, is not suitable for L.S. guns, but on an emergency any armourer could fit up a support for the loop.

A copper tube has been introduced for special naval service, which is not liable to fly about (*see* p. 69) if the ordinary copper tubes are found inconvenient in casemates this special tube might be demanded.

The use of the various tubes is given below, but it is as well to point out that when firing the 4½ or 5½ inch mortars with the short copper tube, difficulties have been experienced from the tube expanding and sticking in the vent. The thickness of metal in the mortar being less

---

\* See Extracts, Vol. VIII., pp. 195, 196, and Vol. VI., p. 21, where the result of the examination of tubes at various stations will be found.



than three inches, the tube is unsupported at the bottom and hence would expand ; probably the special 7-pr. tube would be the best to issue for these pieces.

Full directions for the proof of tubes by firemasters will be found on page 266.

In reporting upon the condition of tubes, all the marks on labels, the condition of the cylinders, and the metal of which the cylinder is made, whether tin or zinc, should be stated.

Tubes may fail in different ways\* and firemasters should state how the failure occurred.

A tube may fail.

- (1.) From the friction bar breaking.
- (2.) From the detonating composition failing to ignite when the friction bar is drawn.
- (3.) From the mealed powder failing when ignited, to fire the puff.

As a rule the detonating composition is found to keep well.

† FRICTION tubes of copper about .2" diameter are used for firing guns in the L.S. Tubes, copper friction.

There are three sizes, viz., the short friction tube about 3" in length for guns in general, a special tube about 2" long for the 7-pr., and the long friction tube about 5" long for 10" R.M.L. ‡ guns and upwards in the L.S. § 2049.  
§ 2448.

There is a special 5 inch tube with a wire attached to keep it from flying, issued for all the Woolwich guns in the Navy, when waterproof cartridges are used, a small lanyard is hooked on to the wire and hitched on to the gun carriage. Special 5" tube.

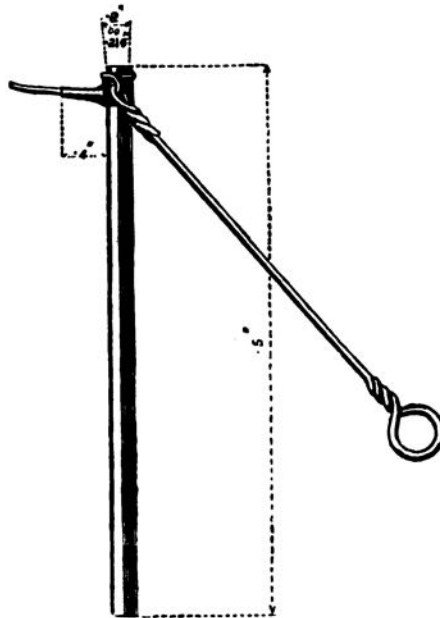

\* Occasionally bad tubes may be restored by drying them for about 56 hours in a room heated to a temperature of 95° Faht., this plan might be tried on an emergency, but little dependence can be placed on it.

† Proportion issued, one per round and 10 per cent. spare.— Revised Equipment, 1873.

‡ The short friction tube might be used with 10" R.M.L. guns and upwards when the long are not available, but an occasional missfire may take place.

The friction tube consists of a copper tube driven with mealed powder and pierced with a central hole (*vide* Plate, p. 325), the top stopped with shellac putty and the bottom with a disc of varnished paper; a hole is bored through near the top of the tube in the copper, and a cylinder or "nib-piece," containing a copper friction bar, roughened and slightly turned up at one end, with a small patch of detonating composition of chlorate of potash, sulphur, and sulphide of antimony placed above and below the bar; the nib-piece is pinched down so as to press on the friction bar, the projecting part of which has an eye into which the hook of the lanyard fits.

**Action.**

On pulling the lanyard (which should be stretched and then sharply pulled) the friction bar is drawn out, igniting the composition and firing the tube.

The hole pierced up the centre of the tube composition is important, it gives a passage for the flash, and causes the tube to act instantaneously, without it the mealed powder would burn like a squib and fail to ignite the cartridge.\*

**Issue.**

§§ 1810, 1871,  
2001, 2055,  
2217.

Copper friction tubes are now issued in tin cylinders, hermetically sealed by a tin strip soldered around the junction of the lid and cylinder, containing 25; formerly zinc cylinders holding 25, and secured by a varnished band of tape, were used, but no more of these will be made, as tin has been found superior to the zinc cylinder. The tin cylinder has a loop formed by a corrugated tin strip soldered around the inside, so as to form a rack for each tube.† Four cylinders of short tubes are placed in a wooden case.

On each cylinder will be found several labels, one on top shewing the nature of its contents and one on the side giving directions that it is "*not to be placed in the magazine on any pretence whatever,*" and also directions as to method of opening, and that the cylinder is "*not to be opened until required for use or for special inspection.*"

**§ 2405.**

For garrison service, a tin tube box 4" × 4" × 3" with strap is used for serving the gun, it contains 100 tubes. A Mark II. box is issued which takes the long tube.

**§ 1622.**

For field service a leather tube pocket with strap is used.

**Quill friction tubes.**

§§ 1148, 1613,  
2192.

*Quill Friction Tubes* of two sizes, about 2½" and 4" long are used by the navy. The general principle of construction is nearly similar to that of the copper friction, but differs slightly in several details; a little mealed powder is added to the detonating composition which is put on one side only of the friction bar, the bar passes through the tube. To support the tube when the lanyard is pulled, a leather loop is attached which fastens on to a crutch or pin screwed into the gun near the vent.

**Tube, friction, quill, short. Use.**

*Quill Friction Tube short* is used for Naval S.B. and rifled guns, except when firing reduced charges of 8-inch R.M.L. guns and over, and using waterproof cartridges; it is also used for the signal rocket gun and with life-buoy portfires.

\* Foreign nations employ friction tubes constructed on a similar plan but containing large grained powder, the interstices between the grains act the same part as the hole in the mealed powder, giving free passage to the flash.

Some tubes made on this principle were tried in the R.L., using Curtis & Harvey's No. 6 powder, they did well, but as our own tube answers equally well no extended trial was made. Possibly the grained powder would resist damp better than the mealed.

† The loops were introduced to prevent the tubes exploding when the cylinder fell. A cylinder exploded in 1870, prior to the introduction of the present mode of packing, on falling a height of about 20 feet on asphalte.

## QUILL FRICTION TUBE, MARK II. \*

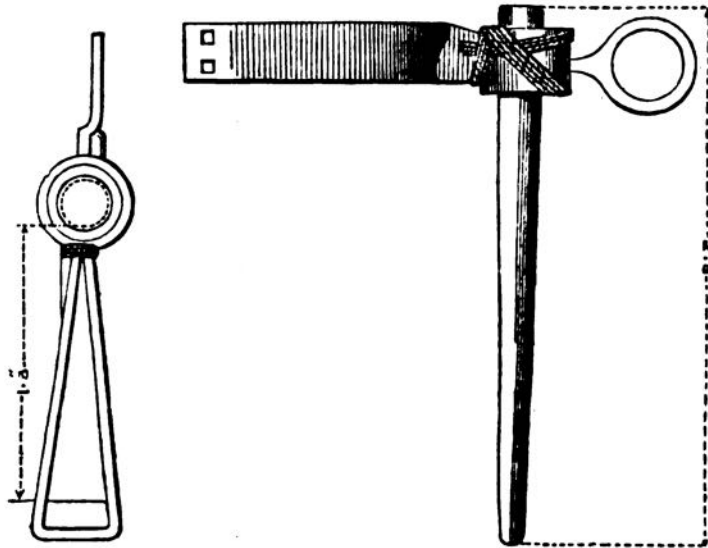

*Quill Friction Tube long* formed by cementing two quills together, is used for firing reduced charges in R.M.L. guns of 8" calibre, and over, and also for the 24-pr, Hales war rocket for sea service.

Quill friction tubes are packed on their sides by 25, in tin cylinders. On each cylinder will be found labels, one on top giving nature of contents, and one on the side directing that it is "*not to be placed in the magazine on any pretence whatever*"; also directions for opening the cylinder and when it should be opened, with instructions for fitting the lanyard and using the tube.

Friction tubes are fired by means of lanyards, of which there are five descriptions. They differ chiefly in length. Those for the navy are made of white instead of tarred line, and have a loop to allow of "half cocking," and a wooden toggle at the end.

Garrison lanyard short, 7' 6" long, having a loop at one end and a hook spliced on at the other.

Garrison lanyard long, for guns of 6 tons weight and over, length 12 feet. This will supersede the short one for all garrison guns. A Mark II. garrison lanyard has been introduced; it has a line with a loop at the end spliced on about 3' from the hook. The loop is made fast so as to prevent the hook from flying back when the gun is fired.

Field service lanyard, length 5' 4"

† Naval lanyard, length 8 feet.

" " " 9 feet 6 inches.

*Common Quill Tube*, about 3" long, can hardly be considered a service tube; it is used when the gun is fired by a portfire. It would be easily manufactured on an emergency. The point of the quill is cut off and a head is formed by slitting the top into 7 prongs and passing a piece of worsted alternately over and under each prong, so as to

\* Mark II., quill friction tube, is shown in sketch.

Mark II. differs from I. only in having a leather wad which keeps the loop open fastened by a single wire.

Mark III. differs from II. in being  $\frac{1}{4}$ -inch longer to ensure more certainty in its action.

† A naval lanyard has been introduced for the 64-pr. R.M.L. converted gun, § 2609. Also a naval lanyard, 18 feet long, for turret vessels, § 2623.

§ 1148.

§ 2192.

form a small cup about  $\frac{1}{4}$ -inch in diameter. The tube is driven with mealed powder, damped with methylated spirits, and a hole pierced by a wire, the cup filled with a priming of mealed powder, gum and water, made into paste, and sprinkled on the top with dry mealed powder. A paper cap is twisted on to the head of the tube, and the wire passed up again after capping to ensure the hole not being choked up. The tubes should be thoroughly dried. They require to be uncapped before firing.

Match or  
Fynmore's  
tubes.

*Match, or Fynmore's Tubes*, have been used as primers for B.L. guns. They are the same as common quill tubes, having in addition 8 strands of worsted covered with a paste made of mealed powder, gum arabic, and methylated spirits fastened to the cup.

Paper tube.

*Paper Tube*, about  $2\frac{1}{2}$ " long. A strip of paper rolled into a cylinder of  $\cdot 2$ " diameter; on to the top of the tube another piece of paper is rolled spirally, so as to make a cup. The tube is driven with mealed powder, damped with methylated spirits, and pierced, and the cup filled with priming of mealed powder and water. The tube is capped by a piece of paper soaked in saltpetre and water, and tied on by silk. After capping, a wire is passed up to ensure the hole not being choked. The tubes should be thoroughly dried. The cap need not be removed before firing. This tube is not a service one, but might be made on an emergency to be used with portfires.

Coated with black varnish, shellac dissolved in methylated spirits would answer.

§ 2484.

#### ELECTRIC FUZES, TUBES, AND DETONATORS.

Patterns of the undermentioned fuzes and detonators, Nos. 2, 3, 5, 6, 7, and 8, have been sealed to govern future manufacture.

In order to facilitate reference and identification, the whole of the electric fuzes, &c., including the fuze, electric, Abel, Mark II, and tube electric, Abel, Mark III, now in the service, have been numbered from 1 to 8, they are also painted different colours, as shown below, viz. :—

(No. 1.) Fuze, electric, Abel, Mark II, § 1512. Painted black.

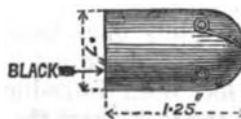

(No. 2.) Fuze, electric, submarine, Mark I. (for instructional purposes only). Wood head painted black, tin part lacquered.

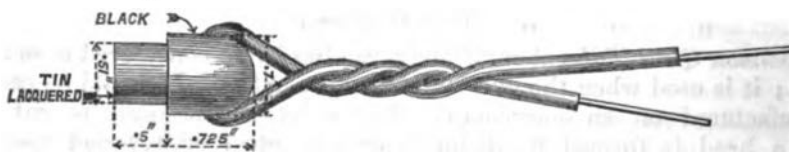

(No. 3.) Fuze, electric, platinum wire, Mark I (for instructional purposes only). Painted white and stamped with letter "P."



(No. 4.) Tube, electric, Abel, Mark III, § 2384. Painted black.

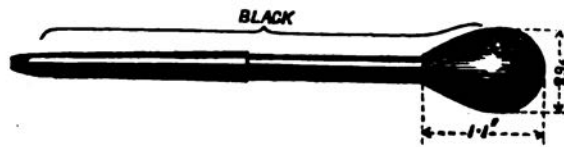

(No. 5.) Detonator, electric, Abel, Mark I. Painted red.

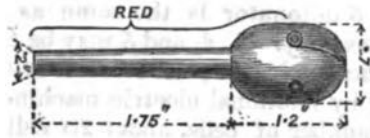

(No. 6.) Detonator, electric, submarine, Mark I. Wood head painted blue, tin part red.

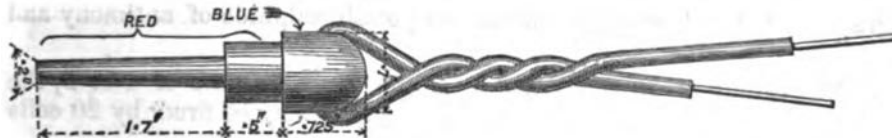

(No. 7.) Detonator, electric, platinum wire, Mark I. Wood head painted white and stamped with letter "P," tin part painted red.



(No. 8.) Detonator for Bickford's fuze, Mark I. Painted red.

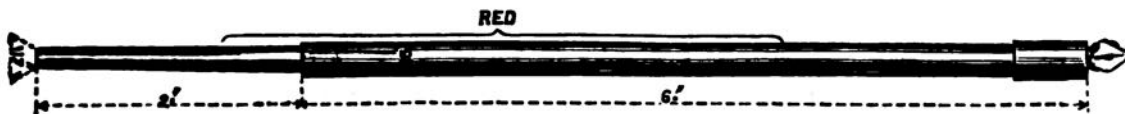

(No. 4.) *Abel's Electric Tube.*—Two fine copper wires pass down Abel's electric tube through the head, covered with gutta percha, except very small pieces at the ends. These uncovered pieces are fixed at a distance of  $\frac{1}{8}$ " from one another, and the space between them filled with a composition of sub-phosphide and sub-sulphide of copper and chlorate of potash; the other ends of the two wires are bent back and brought in contact with the copper lining of two holes passing through the head of the tube. When the wires of a battery are inserted in these holes, the current passes through the wires and the composition between them, igniting the composition in its passage. The quill tube attached to the head is driven and pierced as usual. Any kind of electricity will ignite these tubes; they are used for proof of guns, firing time-guns by electricity, &c. Use. A fuze on the same plan will be used with torpedoes, though a different



composition may be employed. A magnetic exploder is the handiest way of igniting these tubes for L.S.

Issue. In tin cylinders containing 25 each.

Though either frictional or voltaic electricity will fire this tube, it is essential that it should be at a high tension, therefore, when a battery is employed, a number of cells must be used.

The priming of No. 1 fuze is the same as that of No. 4 tube, given above; the body contains mealed powder. It is only used for drill purposes.

The priming of No. 5 detonator is the same as 1 and 4; the tube contains fulminate of mercury. 1, 4, and 5 may be fired by Wheatstone's or Browning's magnetic exploders; (the latter is the most powerful), by dynamo electric, or by frictional electric machines, and by batteries composed of a large number of cells, about 20 cells of Walker's\* will fire them. They may be tested by 24 cells of a water battery, for this purpose no acid must be used. The plates employed are about 4 inches square.

No. 2 fuze. The priming of No. 2 fuze, consists of fulminate of mercury and graphite, the body contains chlorate of potash, sulphide of antimony and sulphur.

No. 6 de'to-nator. The priming of No. 6 detonator is the same as that of No. 2, the tube contains fulminate of mercury. 2 and 6 may be fired by 20 cells of Walker's battery, and may be tested by one cell.

No. 3 fuze. The priming of No. 3 fuze, consists of a thin platinum wire surrounded by gun cotton, the body contains mealed powder.

No. 7 de'to-nator. The priming of No. 7 detonator is the same as that of 3, the tube contains fulminate of mercury.

They may be fired with two, and tested by one cell of Walker's battery.

---

\* INSTRUCTIONS FOR THE USE OF WALKER'S BATTERY.

1. The cells are to be filled with diluted sulphuric acid up to the red line on the plates, and a small quantity (about 4 oz.) of mercury is to be placed in each cell.

2. The acid should be in the proportion of 1 sulphuric acid to 8 water by measure, and should be kept in a bottle when not required for use. The battery cannot be used until the mixture of acid and water has become cool, the same mixture will remain efficient for some months.

3. In testing fuzes or detonators, platinum wire, with the detector galvanometer; this instrument must be placed so as to be included in the circuit. The movement of the index needle shows that the fuze, &c. is correct. When the battery is used without the galvanometer, the platinum wire will become red hot, and the fuze or detonator will be fired.

4. Either one or both cells of the battery may be used. In the firing test the wires should not be longer than necessary; one at least should be insulated with gutta percha, or other material, in order that the circuit might not be accidentally completed. After the operations are over the cells are to be emptied and the plates dipped in water before being replaced in the box.

5. Three distinct wires are required when the detector is used, one to proceed from one pole of the battery to one of the binding screws of the detector, another from the second binding screw of the detector to one of the wires of the fuze, and the third from the other pole of the battery to the other wire of the fuze.

6. When detonators are being tested it is advisable, on account of the greater intensity of the bursting charge, that the detonator should be covered up by a box and be at a safe distance from the operator.

7. When the firing key is used it must be made a part of the circuit, and of course an additional wire will be necessary.

**N.B.**—One cell will generally fire them when the galvanometer is not in the circuit.

No. 8 detonator contains fulminate of mercury in the small part of the tube, quick match is led from the small tube into the larger one. When required for use, Bickford's fuze is inserted into the larger tube, the paper cap being removed, and pressed well down, so as to ensure contact with the quickmatch. No. 8 detonator.

For Bickford's fuze, *see* p. 80, a sufficient length must be employed to allow the operator to get out of the way.

This detonator will be suitable for such work as destroying stockades bridges, &c.

The firing batteries given above are only suited for firing the fuzes and detonators through short circuits, much heavier firing batteries are employed in connection with torpedoes.

The instructions given above will enable firemasters to ascertain the condition of electric tubes, &c., if called upon to do so.

Of the above fuzes, tubes and detonators, the Abel electric tube is the only one directly used in connection with artillery, in the Sea Service it is used for firing simultaneous broadsides, in the Land Service it is in use for proving guns.

Mark III. tube only differs from II in being 1.35 inch longer so as to ensure ignition of the cartridges in the heavier natures of guns. Mark II. is to be retained for L.S. § 238.

Mark II. differed from I, in having the top of the tube brought nearer to the priming, thus making ignition more certain. § 1237.

Though the fuzes and detonators of this class are not used with artillery, they are indispensable for mining purposes. For issue, *see* p. 309.

*Tube, Rocket, Life Saving*, consists of a quill about 1½" long, driven and pierced as usual. Into the top is cemented a pigeon quill, containing detonating composition, chlorate of potash, sulphide of antimony, and ground glass. Tube, rocket, life saving.

In tin cylinders containing 150 each.

Issue.

*Dummy steel friction tube*, issued for drill, consists of a steel pin which fits the vent, having a prong in the head, into which a V shaped spring fits, representing the friction bar. The lanyard is spliced on to the spring, which can be drawn through the prong. Dummy steel friction tube. §§ 802, 918.

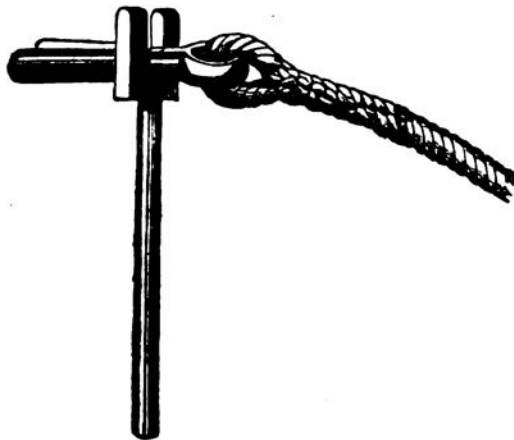

Apparatus for  
proof of tubes.  
§§ 2031, 2101,  
2296.

Apparatus for the proof of tubes are issued to inspectors of warlike stores, and directions are issued with the stands. See Appendix, p. 266.

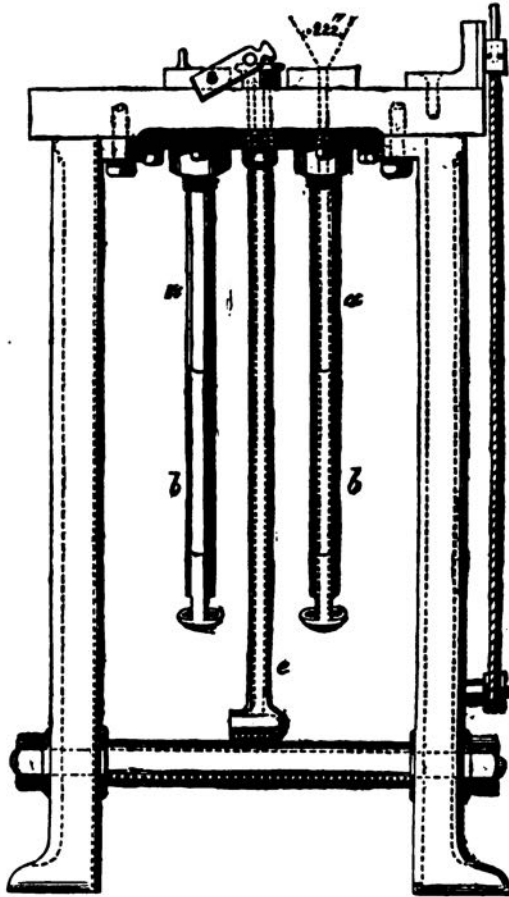

Stand for proof of tubes and primers.

When tubes for general service are tested, *b* is removed. *a* and *b* are used when testing the long tube. *e* is used to test the primers for Shrapnel shell.

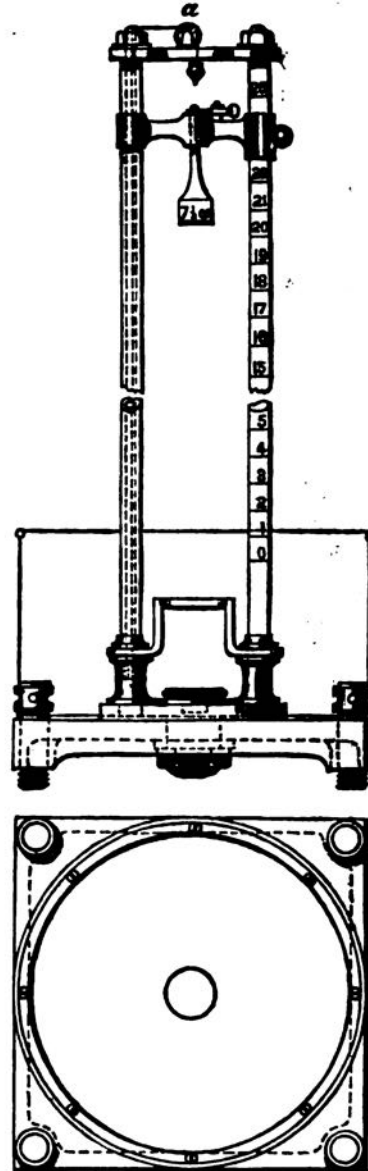

Stand for proving detonators of Pettman fuzes, and of B.L. time fuzes.

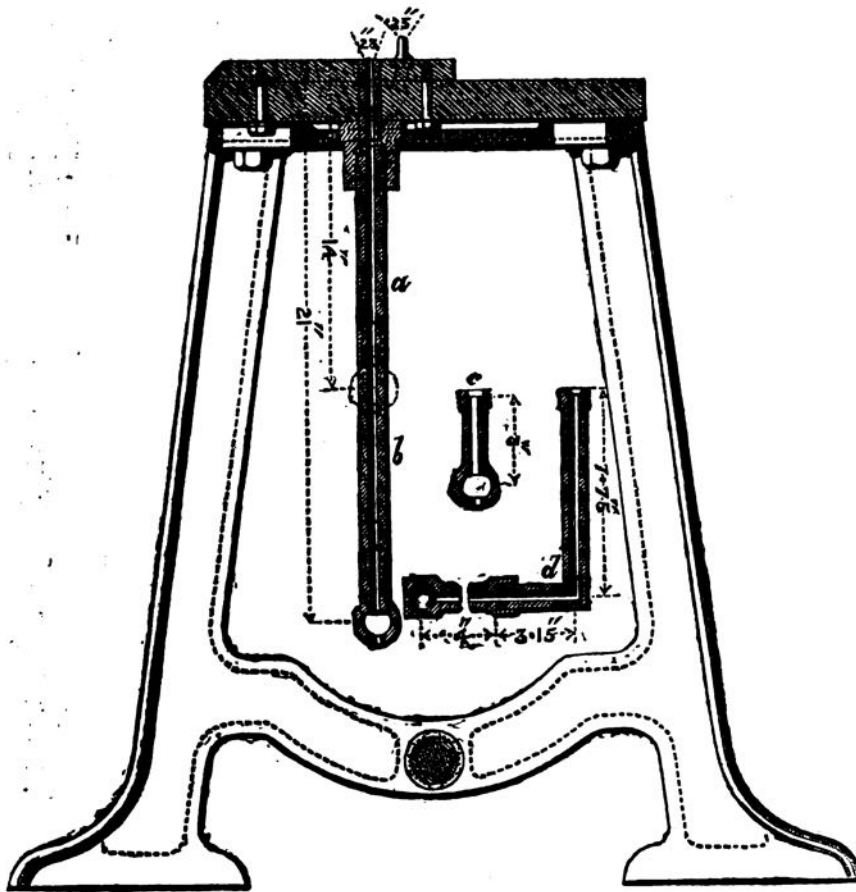

Section of stand for proof of tubes and primers.

*c.* is used to test the special tube for the 7-pr., *d* to test the primers for the vent pieces of B.L. guns.

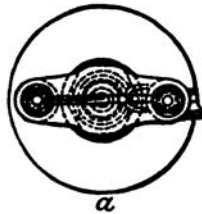

Stand for proof of B.L. plain and R.L. screw percussion fuses, Mark I.

Common portfire.

\* *The Common Portfire* consists of a cylinder 16" long, and rather more than half-inch in diameter, made of stout paper pasted, rolled up,† and when dry turned in at one end to form a bottom. The empty case or cylinder is supported in a mould and driven with portfire composition, consisting of saltpetre, 6 lbs., sulphur, 2 lbs., mealed powder, 1 lb. 4 oz.

The top has a small hole bored in the composition, and is primed with mealed powder to make it light easily; the exposed end is secured by a paper cap, tied on with twine. They burn from 12 to 15 minutes, and are generally lighted by slow match.

Issue.

In bundles of 12, packed in deal boxes.

Miners' portfire. § 2624.

Is longer, thinner, and more lightly driven than the common portfire; it burns about seven minutes. It is removed from the list of service stores.

Slow or blue portfire. § 2624.

*Slow or Blue Portfire* could be easily made on an emergency, and has the advantage of not showing flame at night or dropping sparks. Made of blue, porous, unsized paper (any porous paper would do, blotting paper, &c.), saturated with a boiling solution of 3 oz. saltpetre dissolved in one or two quarts of water; the more porous the paper the more water is required. When dried the paper is rolled into a solid cylinder, about 16" long, and a little over half-an-inch in diameter. Burns two to three hours. It is removed from the list of service stores.

Coast Guard light. § 1724.

*Coast Guard Light*, Mark I., has superseded the coast guard portfire; it burns about five minutes. The spike at the end is to enable the light to be struck in the ground, as a man holding it might be fired at by smugglers. The light is ignited by placing a G.S. primer in the hole in the head marked with a black dot, the wedge-shaped paper covered part of the primer is inserted and the pin projects; a sharp blow struck with this pin on any hard substance ignites the light.

G.S. primer. § 1725.

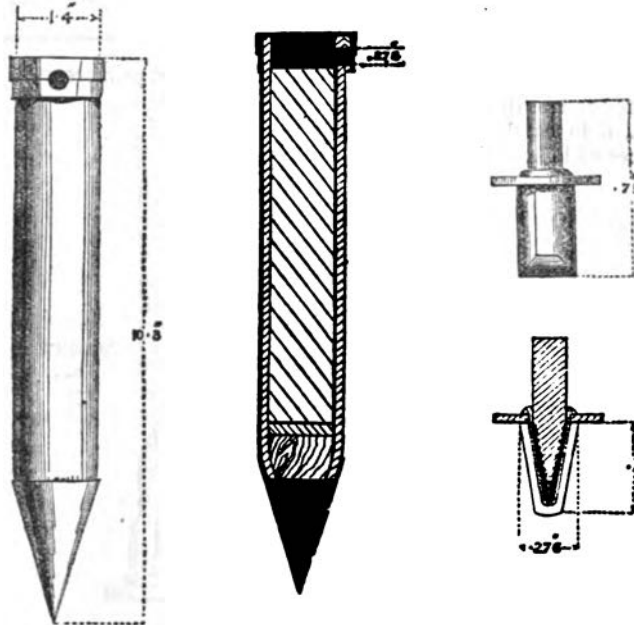

The primer is made on a similar plan to the friction tube, the pin is roughed and coated with the friction tube composition, and the blow driving it through the wedge-shaped copper case explodes it. The case is

\* Issued in the proportion of four per 100 rounds.

† The case is rolled on a steel former, but any smooth cylindrical stick would do.



open at one end and protected by varnished paper. Primers are issued § 1727. in tin boxes holding five or ten.

The composition is saltpetre 7 lbs., sulphur 1 lb. 12 oz., red orpiment 8 oz. The cap of this light need not be removed before lighting. The top of the composition is primed with mealed powder and the flash blows off the cap.

In tin cylinders containing 4.

*Life Buoy Portfire*, burns about 20 minutes ; they are ignited by a quill friction tube which is so arranged that on pulling the trigger to release the buoy, the tube is fired and the portfire ignited.

*Light Long G.S.* burns about five minutes, ignited by G.S. primer as described with coast guard light, it has about  $6\frac{1}{2}$ " of the same composition. A hollow wooden handle with a screw at the end holds eight primers, the handle fits into the projecting socket of the light and is fastened by a wooden pin which is tied on to the handle. The old long light was lit by a cap.

They are used for signalling and illuminating both in L.S. and S.S.

In tin cylinders containing 4.

*Light, Signal, Magnesium*, burns one minute with a very brilliant white flame ; its method of ignition, &c. is the same as described with the coast guard and long light, it has about  $2\frac{1}{4}$  inches of composition, containing, saltpetre 14 lbs., sulphur  $3\frac{1}{2}$  lbs., red orpiment 1 lb., magnesium containing 25 per cent. of paraffine,  $\frac{1}{2}$  lb. The handle is the same as that for the long light. They are used for signalling or illuminating.

In tin cylinders containing 4.

Patterns have been sealed to govern supplies for the Board of Trade.

The light is about  $28\frac{1}{2}$  inches in length and 2.65 inches in diameter.

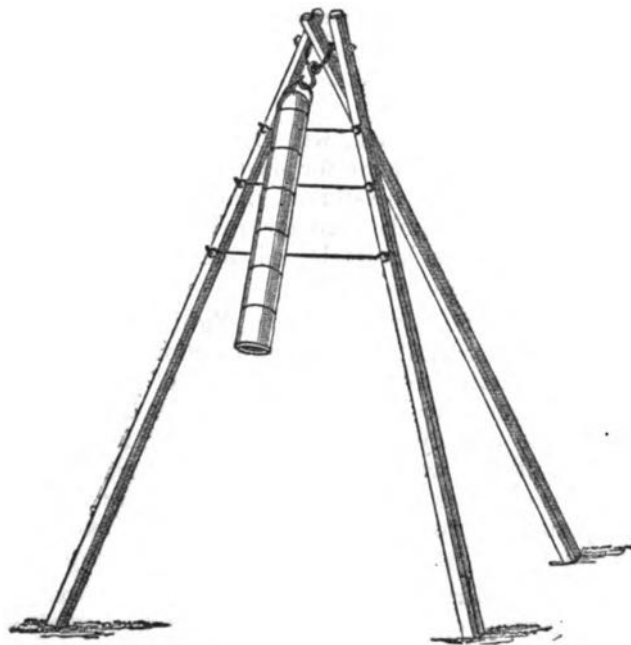

It consists of a cylindrical case of 1 X tin sheet in 6 lengths of  $4\frac{1}{2}$  inches each, fitted together and connected by small bands of tin sheet, half an inch in width, soldered over each joint.

Issue.

Life buoy portfire.

Light long G.S. § 1721.

§ 1726.

Issue.

Light, signal, magnesium.

§ 1723.

Issue.

Light for illuminating wrecks.

(Mark I.)

Stand for ditto.

(Mark I.)

§ 2488.

The case is filled with the following composition, viz. :—

Saltpetre, ground	.. ..	7 lb.
Sulphur, sublimed	.. ..	1 $\frac{3}{4}$ lb.
Orpiment, red	.. ..	0 $\frac{1}{2}$ lb.

§ 2598. One end is fitted with a piece of wood, with a loop of iron wire attached to it for suspending the light ; the other end is primed with mealed powder, and covered with a kit plaster.

The stand is a simple tripod, consisting of three wooden legs about six feet in length, connected at the top by a piece of iron wire, having a small hook attached to it, on which the light is suspended ; there are three iron rods which are hooked to and connect two of the legs, forming an incline for the light to rest on, so as to hang in a sloping direction—not vertically downwards.

The light, if hung as described, clears itself of dross when burning, and is kept further clear by the case separating at each joint, as the heat of the burning composition successively melts the soldering of the bands.

The time of burning is about 30 minutes.

This light must not be roughly handled or thrown about, as it is liable to be broken across at the junction of the segments.

Care must be taken in removing the cap before lighting.

The case must be grasped firmly at the capped end whilst the cap is torn off by means of the string loop ; if there is any difficulty in removing the cap it must be eased off round the edge by inserting the blade of a knife.

Quick match. *Quick Match.*—Is made of cotton wick boiled with a solution of mealed powder and gum.\* For proportions *see* Table, p. 296.

Unenclosed it burns at the rate of about 1 yard in 13 seconds ; when enclosed in a tube of any kind it burns much more rapidly, being as instantaneous as a train of gunpowder, the pressure causing the gas to rush forward and fire the mass explosively. Quick match is made up in paper tubes when this rapid action is required, and when so made up is termed a “leader.”

The proportions of powder, &c. will vary with the number of threads in the wick, those given above are for six-thread wick. Quick match is demanded by weight, 1 lb. of six-thread match would be about 360 feet long. Quick match is largely used for priming fuzes, &c.

Issue. Either in long packing or in metal lined cases, and should be demanded by weight.

Slow match. *Slow Match.*—Is made of pure hemp slightly twisted and boiled in a ley of water and wood ashes in the proportion of water, 50 gallons, wood ashes, one bushel ; this serves for 100 lb. of yarn. It burns at the rate of one yard in eight hours, it is used for lighting portfires, &c. Slow match may be equally well made by boiling in a solution of 8 oz. saltpetre to one gallon of water.

Issue. Loose in skeins or parts of skeins placed in a case with other stores. When large quantities are demanded it is issued in bales or casks. It should be demanded by weight ; about four yards goes to 1 lb.

Bickford's patent fuzes. *Bickford's patent fuzes,* burn at the rate of about one yard in 70 seconds, they are made of flax with a column of fine gunpowder in the middle. There are about nine kinds, which vary in the amount of protection given to the flax according as it is wanted to burn in the air, dry

\* A portion of the powder is kept dry and dusted over the quick match.

or damp ground, or water. A portfire is the readiest way of igniting this fuze.\*

The following is a brief description, mainly taken from W.O. Circular 406, of the fuzes most generally used in the service.

*No. 2 Patent Safety Fuze.*—The flax is protected by a coating of tar, and the fuze “is adapted for all blasting in dry ground, being made with an ample quantity of the best materials. When kept at a moderate temperature and carefully used, its certain operation is warranted.” No. 2, patent safety fuze.

*No. 2\* Patent Safety Fuze* “is the same fuze as the preceding, and is only adapted to the same kind of blasting, but is specially varnished for any given climate. That varnish which is suitable for a cold country becomes soft and sticky if exposed to much heat, while that which is suitable for a hot country becomes hard and brittle if exposed to great cold. This inconvenience is remedied as much as possible by the special preparation of the varnish to suit any given temperature, and which should be specified in the order.” No. 2\* patent safety or dry soil fuze.

*No. 5 Patent Taped Sump Fuze* is covered with varnished tape, twisted round the fuze over the tar. It “is adapted for use in wet ground, and is specially protected, so as to operate efficiently even when the tamping is saturated with water. In such cases the charge of gunpowder should be placed in a cartridge, the end of the fuze should be inserted into the centre of the charge, and the junction of the fuze with the cartridge should be properly protected with a waterproof varnish. If employed in this manner, its certain operation is warranted.” No. 5 patent taped sump or wet soil fuze.

*No. 7 Patent Gutta-Percha Fuze* is covered with gutta-percha, and “is adapted to subaqueous blasting, where it is not liable to much motion from waves or currents, nor subjected to much pressure. It has answered its intended purpose after it has been under water for 24 hours, with a pressure of 40 lbs. to the inch; this is equivalent to the weight of water at the depth of 88 feet.” No. 7 patent gutta-percha, or water fuze.

*No. 9 Patent Taped Gutta-Percha Fuze.*—“This is the same fuze as No. 7, and is adapted to the same use and duty; but, having an exterior coating of tape and varnish, which delays the oxidation of the gutta-percha, it retains its efficiency for a much longer time. It is therefore well adapted for service in distant countries.” No. 9 patent taped gutta-percha or water fuze.

In tin cases of three sizes, containing 8, 24, and 50 fathoms.

Issue.

Bickford's fuze when required for issue to the navy will be packed in tin cylinders containing two lengths of four fathoms each. This order does not affect the use of the case for boat magazines (§ 1701). §§ 2438, 2217.

*Ord's Mining Hose*, has quick match protected by paper and calico hose cemented together with solution of india-rubber and coated by plaited cotton yarn. It is used for firing mines, and acts as a waterproof leader, having instantaneous action. Ord's mining hose. §§ 1102, 2619.

In lengths, as required packed in a zinc or tin cylinder, or any suitable case. Issue.

\* The gutta-percha covered fuzes must have the gutta-percha removed and the powder laid bare where the fuze is placed in contact with the charge, the same must be done at the end which is to be lit by the portfire. Old fuzes should be tested, as the fuze sometimes deteriorates. Instances have occurred where the fuze has burnt very much too rapidly.

It seems at first sight strange that the action of Bickford's fuze should be so different from the action of quick match enclosed in a leader, its slow action is probably due to the small amount of powder and to the space allowed for the expansion of the gas in the flax coating. Accidents may occur from people supposing the fuze to have become extinguished, and, going up to look, thus exposing themselves to the explosion.

## CHAPTER IX. — PROJECTILES AND CARTRIDGES FOR SMOOTH-BORE GUNS.\*

SHOT, SHELL, AND MISCELLANEOUS PROJECTILES. — GAUGES. — WOOD BOTTOMS.—CARTRIDGES.

### SHOT.

- Service shot.** 1. Shot, solid, spherical, common.  
 2. „ case.  
 3. „ grape.  
 4. „ sand.
- 1. Solid shot.** 1. *Solid Shot* are made of all calibres except the 10", from 3-pr. to 100-pr. inclusive.  
 They are attached (*see* p. 91) to wood bottoms for bronze guns and guns of position, but smooth-bore guns having disappeared from the field batteries and batteries of position, shot with wood bottoms are almost obsolete.  
 Shot are used against masonry, wooden shipping, and masses of men.  
 Hot shot may be considered obsolete as the furnaces are withdrawn.
- § 2375. Shot are fired from guns and carronades and the 12-pr. S.S. bronze howitzer, they are not fired from shell guns 8" and 10".  
 Shot bearers for painting shot are made in the Royal Laboratory.
- Issue.** Loose for garrison service. Loose, prepared for bottoms for Indian F.S. Riveted and boxed for F.S.  
 Steel and chilled iron shot were issued for 100-pr., and 68-pr. guns for use against iron-clad ships, but as smooth bores are powerless against the iron-clads of the present day, these shot have become obsolete and are to be used as common shot. Steel shot have an S stamped on them, and are painted white. Chilled shot are painted black with a white belt.
- 2. Shot, case.** *Case Shot* are made of all calibres; they consist of sand shot made up in cylinders, and packed in wood shavings or saw dust.  
 1192. The 100-pr. 10", 8", or 68-pr. and 32-pr. have the cylinder made of sheet iron with iron ends and handle; the 10", and 8", or 68-pr. are rounded at the bottom to facilitate loading. The 56, 42, 24, and 18-prs. have the cylinder made of tin with an iron bottom and rope handle. The bronze guns and howitzers and iron guns of the same calibre, viz., 6, 9, and 12-pr., guns, 4½", 12-pr., 24-pr., and 32-pr. howitzers have the cylinder made of tin with a wooden bottom to avoid injury to the bore of the bronze guns, and for the sake of similarity of pattern in the case of the iron guns. The case shot for the 5½" iron howitzer has also a wooden bottom.  
 Carronade case is not issued. Gun or howitzer case is used instead. Case for bronze howitzers has H stencilled in white, an inch and a half long, to distinguish it.

\* The calibres of the S.B. guns are—100-pr. 9", 68-pr. 8·12", 56-pr. 7·65", 42-pr. 6·97", 32-pr. about 6·85", 24-pr. about 5·82", 18-pr. 5·29", 12-pr. 4·62", 9-pr. 4·2", 6-pr. 3·67", 3-pr. 2·913. The windage generally lies between ·1 and ·2".

† All service projectiles are painted black; such as are issued with wood bottoms, together with case shot, grape shot, and filled mortar shell are packed in boxes, otherwise they are issued loose.

**Paint.** † When fired under 3° of elevation, grummet wads are used, consisting of rope bent in a circle, and held in position by two cross pieces of small rope. The cross pieces go outside next the rammer head, otherwise they may be withdrawn by the rammer. Junk wads are made up of old junk beaten into a solid cylinder and woolded over. They are now only used in connexion with tampions.

In loading, the rule is always to put the handle away from the charge, except when it is made of rope, when the reverse is the case. The wood bottom goes next the charge.

Case shot are filled with sand shot, which vary in weight from 1 lb. to 8 oz. with heavy guns down to 32-pr., and vary from 8 oz. to 2 oz. with the smaller guns.

Case shot are fired from all natures of guns, howitzers and carronades, against troops in masses, for flanking ditches, &c., and against boats and rigging of ships. They are effective up to 350 yards. Case which have wood bottoms follow the rule laid down as to shape given in page 91.

Case are issued in rough deal boxes with elm ends; the number in a box varies with the calibre of the shot.

3. *Grape Shot* of all calibres from 6-pr. to 10 inch inclusive is being superseded by case. The pattern at present in use is "Caffin's" pattern.

The sand shot are held in position by four iron circular plates pierced with holes to grip the shot, an iron spindle passes through the plates, and a nut which screws on to the head of the spindle binds the plates and shot together.

Carronade grape is to be broken up when returned to Woolwich, it was made up in tin cylinders and painted red. At out stations it is retained for local issue if serviceable.

The 10" gun has special grape made up in cylinders like case, but has larger balls; it is known by having G. stencilled on it in white, an inch and a half long.

The sand shot vary in weight from 4 lbs. to 13½ oz.; it will be seen that they are heavier than the sand shot used for case, and consequently there are fewer of them.

Grape was used for the same purpose as case; it is effective at longer ranges than case, and would probably be more destructive to boats and rigging. It may be used up to about 600 yards.

Made up in boxes, the number in a box varies with the calibre of the shot.

4. *Sand Shot* are seldom used as projectiles by themselves; they may be fired out of a mortar as pound shot, in which case a wooden bottom is necessary. They are cast-iron balls varying in weight from 4 lbs. to 1½ oz.; their chief use is in the manufacture of case and grape and also Shrapnel for the Woolwich rifled guns.

Black if used for grape, otherwise unpainted.

When issued as pound shot they are packed in boxes containing 100 or 50.

*Hollow Shot* may still be met with; no more will be made. They are to be used up at practice, and are known by their weight.

#### SHELLS.

All filled shell have "filled" stencilled on them in red, and if filled in any arsenal or dockyard would have the monogram of the station and the date of filling in addition, the boxes also would be marked "filled" in red. Shells for field batteries are carried filled in the limbers and wagons.

1. Common.
2. Naval.
3. Mortar.
4. Hand Grenade.
5. Diaphragm Shrapnel.

Classes.



1. Common shell.

1. *Common Shell*, gauge, common. \* Fuzes, common time and Pettman's L.S. percussion. They are fired from guns, howitzers, and carronades, and 5½ and 4¾" mortars, and are made of all calibres from 12-pr. to 10" inclusive, except 100-pr., which has naval shell; they are about ¼th of their diameter in thickness, and weigh empty about ¾ the weight of solid shot of the same calibre; the 10" is ¼th in thickness; they have wood bottoms in accordance with rule on page 91, and have a fuze-hole of the common gauge tapped throughout, so as to take Pettman's L.S. fuze, the fuze-hole is closed with a gun-metal plug marked with a × to show that the thread is tapped throughout; the plug has a shoulder fitting into a recess, a leather collar fits under the shoulder to make the joint tight, the fuze-hole is countersunk, which enables them to be used as shot without bottoms.† Mark II. common plug differs from the previous pattern in having no shoulder, and may be known from the G.S. plug by having a + marked on it.

§ 1603.

The 12-pr. shell has a gun-metal socket fitted into the fuze-hole extending some way into the interior of the shell. Without this the shell failed to burst as the powder was not sufficiently confined, the size of the fuze-hole being large compared to the size of the shell.

Blowing charges.

All common shell are completely filled with powder (L.G. shell), see page 51. For practice in places where the full charge might be dangerous, blowing charges are used, 3 oz. up to the 24-pr. inclusive, and 4 oz. for the higher natures; they are put in loose, except when the small mortar fuze is used with the 12 and 24-pr. shells when fired from 4¾ and 5½" mortars, in which case the charge is placed in a small red shalloon bag, *vide* p. 86.

§§ 1698, 1841.

Full directions for filling shell and securing them are given on p. 51. It may be pointed out that a shell with its plug and wad in it is secure against being ignited by an explosion near it;‡ the wad alone has been found to protect the powder when the plug has been shaken out. It is also to be remarked that the wad does not require removal before inserting the fuze, as the fuze drives it in on being set home; directions for boring and fixing fuzes are given on page 53.

12 and 24-pr. common shell are used with the 4¾ and 5½ mortars; they are to be of small gauge, and it is directed that at out stations shells for this purpose are to be tried by testing them with the mortars themselves; the common fuze would be used with these shells when fired from mortars, except at long ranges, when the small mortar fuze would be used.§

The 10" being a weak gun causes some exceptional arrangement with its shell, thus the gun may not be double shotted; so with 10" naval shell a special bottom is used, having two rivet holes, besides the ordinary hole for L.S., in order that it may be attached by either the naval or L.S. method; also its common shell is thinner, as the gun has a light charge; it has no Shrapnel, as the weight would strain the gun too much. 10" shell which weigh over 85 lbs. are to be condemned, and may be converted to mortar shell.

Use.

Common shell are used against men in masses, houses, buildings, shipping, and material generally; they may be used either by bursting

§ 773.

\* Proportion of fuzes. One common fuze to two common shells and 20 per cent. spare; and one Pettman's L.S. percussion fuze to every two shells.—Revised Equipment, p. 10.

† Plug, common, with lanyard attached, is issued for drill purposes.

‡ They might, however, explode if struck directly by a projectile, or by a piece of a burst shell.

§ The proportion of fuzes issued for 5½" shells is one common fuze to three small mortar fuzes for 4 shells; for 4¾" nine common fuzes, and one small mortar fuze for 10 shells; 20 per cent. to be spare in all cases.—Revised Equipment, p. 16.

them in flight, when they act both by the velocity with which the shell is moving and by the force of the bursting charge; but they scatter too much in this way, and are not so effective against men as Shrapnel. They may also be used by bursting the shell when at rest, when they act as a mine; they are most destructive against wooden shipping; they would also be available against men in hollows or sheltered by buildings, where Shrapnel would be powerless.

Recovered shell that have been fired at practice may be used again, §§ 1610, 1778. filled with sand only; they should have a red ring round the fuze-hole to show that no powder is to be used (recovered mortar shell may be used with blowing charges), and also the yellow line for practice. Recovered 32-pr. naval shell are not to be used because of the projecting bush.

Empty, loose, prepared for bottoms for garrison service, and for India, Issue. garrison, and field service.\*

Filled, riveted, and boxed for field or boat service. When for boat service, issued fuzeed with Pettman's L.S. percussion.

*Naval Shell.*—Calibres, 100-pr., 10", 8", or 68-pr., 32-pr. Gauge, Naval shell. G.S. Fuzes, 9 or 20 seconds M.L. Mark I. and Pettman's G.S. percussion. Naval shell differ from common in having the G.S. gauge (an adapter converts them from the old Moorsom gauge), and in having their bottoms attached by two rivets.

The fuze-hole is closed by the G.S. plug, which has no shoulder. The object of having the bottoms hollowed out is to have the iron of the projectiles in contact, otherwise they are likely to split when double shotted. The 100-pr. has a top attached in place of a bottom. Space in stowage is saved by this plan, and the fuze is well protected.

Naval shells are generally issued filled, riveted to bottom or top, and fuzeed with G.S. percussion fuze; those with bottoms are boxed. For L.S. would be issued empty, prepared for bottoms.†

The adapter for naval spherical shells is made of gun-metal, tapped externally to fit the Moorsom gauge, and internally with the G.S. gauge.

*Mortar Shell.*—Calibres, 8", 10", and 13". Gauge, large mortar. Mortar shell. Fuze, large mortar.‡ Fired from 8", 10", and 13" mortars. The fuze hole is not regularly tapped, but is roughed, except a small part at the bottom. The 8" is roughed throughout. The gauge is much larger than the common gauge. The fuze-hole of the 8" is a little smaller than the others, as otherwise the fuze would touch the bottom of the shell before it was fixed in the fuze-hole. Of course this makes the fuze protrude farther. The 10" and 13" shell have lugs; hooks Hooks, beam and hand. fit into the lugs to enable the shell to be carried. The 13" have the hooks hung by chains from a beam, and are called beam hooks. Hand hooks are used with the 10". In future manufacture lewis holes would be used. The holes incline inwards, and the iron plugs at the end of the chains bite into them, when the chain to which the plugs are attached is tight, and can be removed when the chain slackens. The advantage of lewis holes is that there is nothing projecting which is liable to be broken off in piling or transit. The 8" shell weighs  $46\frac{1}{16}$  lbs., the 10",  $87\frac{2}{8}$  lbs., and the 13",  $195\frac{3}{8}$  lbs.

As these shells require no bottoms they have no rivet holes.

For L.S. they are issued loose, the fuze-hole closed with a beeswaxed Issue. cork. This cork may be driven in in the 10" and 13", but must be

\* For 10", 8", and 68-pr. guns two wood shell boxes are provided to carry the shell up to the gun.—Revised Equipment, p. 12.

† Naval shell may be issued for L.S.—Revised Equipment, p. 11.

‡ Proportion of fuzes issued is one per shell and 20 per cent. spare.—Revised Equipment, p. 14.

- pulled out with the 8", as it might otherwise hinder the fuze from being driven home; a corkscrew is provided for this purpose. For sea service they are issued filled and boxed. The fuze-hole is closed with a cork and kit plaster. Kit plaster is stout canvas prepared with pitch, tallow, beeswax, and rosin. See table, p. 297.
- Kit plaster.** To prepare shell, see page 55.
- Blowing charges.** Mortar shells are completely filled, see page 55. For practice, where full charges would be dangerous, blowing charges are used, which are made up in red shalloon bags, narrow at the mouth, and with a brass ring to prevent the bag falling into the shell. They are jammed into the fuze-hole by the fuze.
- 4 oz. used for 8", 10", and 13".  
3 oz. used for 5½" and 4¾".
- Use.** Mortar shells are used for vertical fire, and employed for the bombardment of towns, forts, entrenched positions, &c. They may be employed against shipping, but are too inaccurate to give good results on a small object. The 5½" and 4¾" mortars are used against troops under cover. For this purpose the fuze should be bored rather short to ensure the shells bursting before penetrating the earth. On the other hand, the larger shells used against material should have their fuzes bored long.
- Hand grenades.** *Hand Grenades* are of two sizes, 6-pr. and 3-pr. They resemble common shells, but the walls of the shell are not so thick, being about ¼th of the diameter. The fuze-hole is much smaller, and is not roughened.
- Issue.** They are generally issued empty, loose, for L.S., and filled and fuzed for S.S., the fuze being covered with a kit plaster. These are boxed.
- Use.** They are used chiefly for the defence of places against assault, being thrown among the storming parties in the ditch. They are useful in the defence of houses; sometimes they are fired out of mortars instead of pound shot. They can be thrown by hand about 20 or 30 yards.
- Diaphragm Shrapnel shell.** *Diaphragm Shrapnel Shell.*—Gauge, common. Fuze, diaphragm.\* For all calibres except the 10'.† Fired from guns, howitzers, and carronades. The shell is a thin cast-iron shell (see plate, p. 329), weakened by four grooves down the sides to make it open out, thickened at the junction of diaphragm and shell, as otherwise it would split into two pieces instead of four or five, as desired; thickened at the fuze-hole to support the socket, and thickened at the base in all natures above 12-pr. to withstand the shock of discharge.
- A wrought-iron cup or diaphragm divides the shell into two unequal parts, the smaller forming the powder chamber, and the larger being filled with lead and antimony bullets‡ (lead six parts, antimony one part) packed in coal dust. The antimony hardens the lead and prevents the bullets losing their form by being pressed together.
- The diaphragm has a hole in the centre, through which a gun metal socket passes, which serves to contain the fuze. This socket is not countersunk, as is the case with common shell, but is flush with the surface of the shell. (These shell would not be used as hollow shot so countersinking is not necessary.) Through this socket the bullets are introduced and the bottom of the socket is then screwed in. The socket communicates with the powder chamber by a fire hole. The gun-metal
- 
- \* Proportion issued is one per shell and 20 per cent. spare.—Revised Equipment, p. 10.  
† Shrapnel made prior to 1858 are not serviceable; they may be known by their projecting socket. The details of construction were not matured until 1858. Many of earlier manufacture were made by contract and were liable to break up.  
‡ Musket balls mixed with pistol, to fill up the intervals, are used with the larger natures of Shrapnel, viz., to 18-pr. inclusive, and carbine balls with the smaller.  
As lead is half as heavy again as iron it is much better suited for bullets; sand shot lose their velocity quicker.

plug which screws into it has a wooden plug covered with serge attached which prevents powder working in and filling up the space for the fuze. The powder chamber is filled with pistol or F.G. powder through the § 2286. loading hole. The loading hole varies in size, being smaller for the lower natures of shell up to 18-pr. inclusive.

The main advantage gained by separating the powder is to avoid premature explosions.

For instructions for preparing shell and fuzes, see pages 52, 53.

As a small charge of powder is used merely to open the shell, the Use. effect depends wholly on the velocity with which the shell is moving. The shell should be burst at a distance of 50 to 20 yards in front of the object, and from 15 to 10 feet above the plane. It is most destructive when used against columns, but may be used against troops in line. As the quantity of powder which the chamber holds is only just sufficient to open the shell, it is necessary to measure or weigh the charge to ensure the shells having the full amount of powder.

Empty, loose, prepared for bottoms for India.

Issue.

Empty, riveted, and boxed generally.

Filled, for field, naval, and boat service, and boxed.

N.B.—Shrapnel are always issued with their balls. Mistakes seem to have arisen from Shrapnel being demanded "filled" under the idea that this term referred to balls, whereas it refers to the powder.

Improved Shrapnel have long been discontinued, but may still possibly Improved Shrapnel. be met with at out stations. They may be recognized by their projecting socket and the large hole in the side of the shell through which the bullets were introduced. They scattered the bullets too much, owing to the position of the powder. They are now obsolete.

#### MISCELLANEOUS PROJECTILES.\*

Carcasses.

Ground light balls.

Parachute light balls.

Smoke balls.

Carcasses.—Of all calibres from 12-pr. inclusive upwards, except the Carcasses. 100-pr. Fired from all natures of guns, howitzers, carronades, and mortars.

They are shells with three vents (see plate, p. 329) rather thicker than common shell (about  $\frac{1}{2}$  diameter) to compensate for the weakness caused by the vents. They are a little heavier than common shell of the same calibre. They are filled with composition consisting of—

Saltpetre	-	-	-	6 lbs. 4 oz.
Sulphur	-	-	-	2 " 8 "
Rosin	-	-	-	1 " 14 "
Sulphide of Antimony	-	-	-	0 " 10 "
Turpentine	-	-	-	0 " 10 "
Tallow	-	-	-	0 " 10 "

This composition is put in hot, and three holes made in it in prolongation of the vents. These holes are driven with fuze composition, and matched with quick match to ensure ignition. The vents are plugged with brown paper and further secured by kit plasters.

Before firing, the plasters and plugs must be removed and the priming Preparation. exposed. They burn with a violent flame and are difficult to extinguish.

\* Are not now included in equipment, and would only be issued on special demand, showing for what purpose they are required. These stores are specially apt to deteriorate, hence the rule. Martin's shell was made obsolete by Cl. 18, A.C. 1869. It was introduced to contain molten iron, and was intended to destroy wooden ships.



Water does not put them out. Earth is the best thing to check their action.

Carcasses have been known to burst.

**Use.** To fire buildings, shipping, &c. Carcasses fired from 13" S.S. mortar and 10" gun are to be fired with charges not exceeding 16 lbs. and 8 lbs. respectively to avoid straining the pieces with such heavy projectiles.

13" carcasses burn 12 minutes and the others a shorter time down to the 12-pr. which burns three minutes.

**Issue.** Carcasses are generally issued filled in boxes marked in red as given above for shells.

**Ground light balls.** *Ground Light Balls.*—Calibres, 10", 8", 5½", 4½", fired from mortars only.

**Construction.** They have a wrought-iron skeleton frame (*see* plate, p. 329), partially covered with canvas, filled with composition, consisting of saltpetre, sulphur, rosin, and linseed oil, which is put in hot, and holes made in it, driven with fuze composition and matched as given above for carcasses.

The body is woolded over with twine. The 8 and 10 inch have five vents in the top; the others have four. The vents are secured with plugs and kit plaster, which have to be removed before firing. The 10" and 8" have lugs to facilitate loading.

**Use.** They are used at night to discover working parties, &c., of the enemy, and might, failing carcasses, be used in their place.

As they are required to remain where they fall they are only suited to vertical fire.

The composition is not a very good one but is hard to extinguish, water having little effect on it. A few shovelfulls of earth will hide its light.

Sometimes shells have been placed in light balls to deter men from putting them out, therefore light balls of foreign or doubtful origin should be examined and burned with caution.

Ground light balls weigh from ½ to ¾ the weight of common shell of same calibre.

Time of burning varies from 9 to 16 minutes.

They are fired with very reduced charges, varying from 2 lbs. to 1 oz.

	10"	8"	5½"	4½"
	lbs. oz.	lbs. oz.	lbs. oz.	lbs. oz.
200 yards - - -	0 10	0 4	0 2	0 1
300 " - - -	0 11½	0 6	0 3	0 2
400 " - - -	0 18½	0 8½	0 4½	0 3
500 " - - -	1 0	0 11	0 5½	0 4½
600 " - - -	1 2½	0 14½	0 8½	0 6½
700 " - - -	1 6	1 3	0 12	0 9½
800 " - - -	1 12	1 10	1 0	—
850 " - - -	2 0	1 14	—	—

**Issue.** Ground light balls are issued filled and finished and packed in boxes, No. per box varying with nature.

**Parachute light ball.** *Parachute Light Ball.*—Calibres, 10", 8", 5½", fired from mortars.

Consists of two outer and two inner tinned iron hemispheres, the two outer are lightly riveted together, the two upper hemispheres are connected by a chain, the inner upper hemisphere has a depression at the top to admit the bursting charge and fuze. A quick match leader



conducts the flash from the bursting charge to the fuze composition in the lower inner hemisphere; the inner upper hemisphere contains the parachute tightly folded up; to ensure its opening, a cord is passed between its folds and through a hole in the top of parachute, and is fastened to the upper inner hemisphere, so that when the hemisphere is blown away, the cord is pulled through and the parachute expanded.

Ball, Light, Parachute.

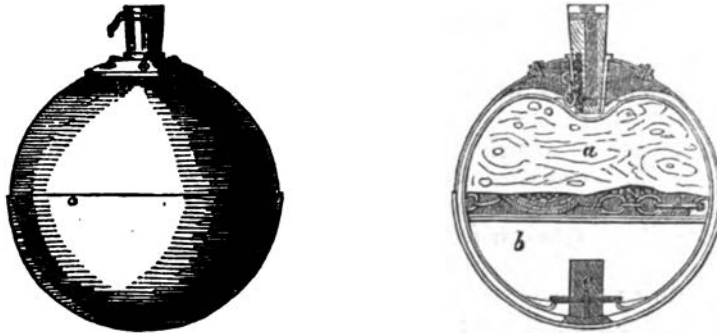

The lower inner hemisphere contains a composition of saltpetre, 7 lbs. ; sulphur, 1 lb. 2 oz. ; red orpiment, 11 oz. A hole is bored and driven with fuze composition and matched as usual, this hemisphere is connected with the parachute by cords and chains.

Parachute open after firing.

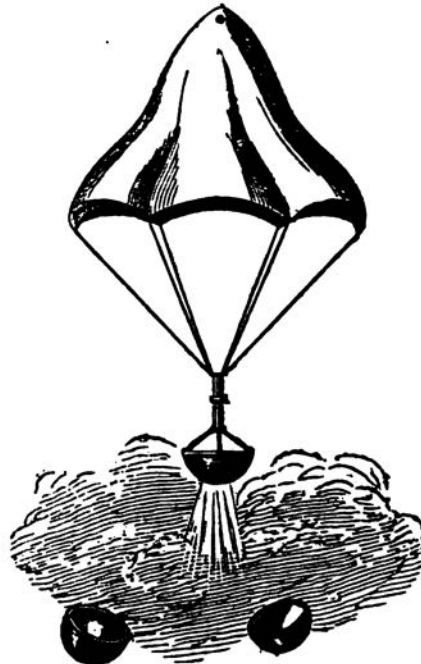

The bursting charge is issued in the parachute, the fuze is bored to Preparation. the required length and well hammered in, the parachute placed in the mortar and fired.

The fuze ignites the bursting charge, the outer hemispheres are blown Action. away, and the inner upper hemisphere which is chained to the outer one is blown away with it, the parachute is opened by the cord and expands,

the composition in the lower hemisphere being ignited by the quick match leader which ignites the fuze composition.

The composition burns about 3 minutes in the 10", 1 minute 40 seconds in the 8", 1 minute in the 5½". The 10" weighs about 30 lbs.; the 8", 15 lbs.; and the 5½", 6 lbs.

The fuze should be so regulated as to open the parachute just as it begins to descend. No fuze tables have been laid down, but about half the length of fuze should be given which is given to a mortar with similar charge.\*

**Use.** Extreme charge for 10", 2½ lbs.; range 1,400 yds.; 8", 1 lb.; 5½", 8 oz. To throw light on the enemy's working parties, &c. at night; it has the advantage of being out of reach, so cannot be extinguished. Careful allowance for wind must be made.

**Issue.** In wooden boxes, one in each.

**Smoke balls.** *Smoke Balls.*—Calibres, 13", 10", 8", 5½" and 4½", may be fired out of mortars with very light charges.

**Construction.** A paper shell filled with L.G. powder, saltpetre, coal dust, pitch and tallow, the vent driven with fuze composition, and matched, and covered with kit plaster, a layer of sulphur, and coal dust is sprinkled in three times during filling; in burning, this clears the vent.

These balls appear to be useless as projectiles, they are intended (1) to put in enemy's mines, (2) to conceal operations from the enemy, (3) for signals in the Arctic regions; they burn from one to eight minutes.

**Issue.** It is very doubtful whether smoke balls have ever been fired.

Filled, finished, and boxed, number per box varying with nature.

**Manby's shot.** *Manby's Shot.*†—Calibres, 24-pr., fired from 5½" mortar.

**Construction.** An elongated shot with 4 holes for fuzes or lights, having a shank to which a stout hide thong is attached. Its use is to carry a line to a shipwrecked vessel, the line being attached to the thong. The shot is placed in a mortar, shank to the front, and the line so coiled as to run out freely is placed to leeward.

Maximum charge, 12 oz., giving 400 yards range.

Superseded by life saving rocket.

**Gauges.** *Gauges*, high and low, see table, p. 299, are issued for every kind of S.B. gun, and for stations of inspection; they are simply iron rings with handles, the high gauge should pass over the shot, the low should not.

§§ 1314, 1698. All S.B. projectiles are below their nominal diameter, while the gun is a little above it, thus an 8" shot or shell has a mean diameter of 7.85".

**Windage.** *Windage* is necessary not only to allow the shot to load easily, but also to allow for the increased size of the shot caused by rust, &c. With shells windage is useful by allowing the flash of discharge to ignite the fuze.

When shot are repainted it is necessary to scrape off the old paint, which can be done with knives or a piece of an old sword or cutlass. See table, p. 297.

---

\* The fuze for a 10" mortar with a charge of 1 lb. is 1.9", the time of flight is about 10 seconds. So firing a parachute light ball with a 1 lb. charge we should bore the fuze about five seconds; the first number marked on the 10" parachute fuze is six seconds, so the fuze has to be bored to six.

† Manby's shot are at present being broken up on return to Woolwich. They are now obsolete.

## WOOD BOTTOMS.

Used with shot fired from bronze guns to save the guns, with shot carried with iron guns of position to steady them in the limbers, also used with all shells except mortar shells, and the 100-pr. naval shell which has a top, and with carcasses except when fired from mortars. They are necessary with shells to keep the fuze, and with carcasses to keep the vents, in the proper position. They are shaped so as to fit the pieces of ordnance for which they are intended; thus, they are conical as a general rule, for all the shell guns and howitzers which have gomer chambers, and for all unchambered ordnance of corresponding calibre, (the 68, 32, 24, and 12-pr. gun shell would have conical bottoms though the guns have not gomer chambers); hemispherical for the 5½" and 4¾" howitzers which have cylindrical chambers, and cylindrical for all other ordnance. Carronades have cylindrical chambers, but if shells were required to be used with them any kind of gun or howitzer shell would be used without regard to the shape of its bottom.

They are made of well seasoned elm or alder, or of teak for tropical climates. The grain runs plankways, except for Shrapnel up to 24-pr., where the grain runs endways, the bottom is carried higher up on the shell, and is secured from splitting by a tin strap, this ensures the bottom breaking up, and so there is less risk when firing over troops in front, also the shooting is said to be improved by the bottom quitting the shell readily.

Common and  
Shrapnel  
bottoms.

It is hardly necessary to mention such an unimportant exception to the rule as the 4¾ and 5½" Shrapnel shells, which have the same hemispherical plank bottoms as the common shells, but the 4¾" has the small Shrapnel rivet hole.

Bottoms for land and boat service are fastened by a single expanding gun-metal rivet; the rivets are of two sizes, small for Shrapnel up to the 18-pr. and large for all other shells, and also for shot; these rivets being hollowed out at the base expand into undercut holes in the shell or shot.

Rivets.

For naval service, to allow of the practice of double shotting, it is found advisable to have the metal of the shells in contact, otherwise they are liable to break up. The single rivet cannot therefore be used, a piece being cut out of the centre of the wood bottom. The bottom is fastened to these shells by means of two inclined rivets, which are simply cylindrical pins of copper not hollowed out and having no heads.\* Here the weakness of the 10" gun leads to its having a peculiar form of bottom, it would be dangerous to double shot the gun, so the bottom is not hollowed out, but it might be inconvenient to have a different plan of riveting for the naval service, so the bottom is prepared to take naval rivets, and to avoid having two kinds of bottoms for this gun it is also prepared for the L.S. central rivet.

Naval bottoms.

10" bottom.

To fasten on bottoms, No. 2 set Garrison is used.

When not issued fastened to the shells they are strung by 20 on an iron rod for land, and on a wooden rod for sea service; 10 per cent. over the number of shells are allowed.

Issue.

Mortar bottoms, 13", 10", and 8" are hemispherical in shape, they are a special store required on firing pound shot or bouquets of small shell from mortars of above calibre.

Mortar  
bottom.  
§ 1582.

Tops were introduced for naval service, they save space in stowage, protect the fuze and facilitate loading, but owing to the introduction of rifled guns they have only been applied to the 100-pr., they are fastened to the shell by four rivets of the same description as are used for naval bottoms.

Tops.

\* Naval rivets are of two sizes. Medium for 100-pr. tops and 32-pr. bottoms; short for 10" and 8" bottoms.

## CARTRIDGES.

**Cartridges.** *Serge* has been used for cartridges owing to its consuming fairly in the gun and standing travelling well ; it is, however, not perfectly safe when fired as blank, because in this case there is not so much pressure and heat as in shotted guns, and the cartridge may not be entirely consumed.

Cartridges are made conical for ordnance with gomer chambers ; cylindrical for all other ordnance. The cylindrical cartridge is made in one piece, the conical in two ; the edges are made to overlap and are sewed together, which avoids the risk of having three thicknesses of *serge* under the vent.

**Filling cartridges.** All cartridges are now filled by weight instead of by measure as formerly. A funnel of copper called the royal naval funnel is used in filling them.

They are hooped and choked with worsted ; the choke is cut off to 1" for all guns except the 100-pr., which is limited to 3".

**Choking.** Choking consists in drawing together the mouth of the cartridge into several pleats with a brass needle threaded with three strands of worsted, 3 turns being taken round the pleats ; the choke thus formed being further secured by passing the needle 5 times through it, alternately above and below the turns of worsted, thereby stitching down the worsted at 4 points equidistant from one another.

**Hooping.** Hooping is necessary to preserve the shape of the cartridge ; it is done as follows :—In making the last stitch in choking, the needle is turned downwards and carried through the powder and out at the seam, dividing the space between the shoulder and bottom of the cartridge according to the number of hoops required ; the worsted is then carried tightly round the cartridge, forming a hoop, which is stitched to the cartridge at 2 or 3 points in the same way as the turns of worsted at the choke were secured ; one, two, or three hoops as required are thus made.

The 100-pr. cartridge is hooped with braid like the cartridge for rifled guns, p. 128.

The diameter of the cartridge is less than the diameter of the bore, to admit of easy loading, and also because the flash would not penetrate so rapidly a cartridge which completely filled the bore ; this rapid burning causes the powder to act more violently, as the charge is consumed before the shot has had time to move far, and the more confined the space in which powder is burned the stronger is its action ; this consideration shows that a limit is soon reached beyond which elongating the cartridge will diminish the force developed by the powder.

Cartridges are painted in black with the weight of charge and nature of gun ; those for howitzers, mortars, and carronades are marked "how." "mor." and "carr."

Cartridges for mortars are issued of a size to hold the maximum charge ; thus a S.S. mortar, 13", has a 20-lb. cartridge, and also a 16 lb. for carcasses. See p. 304 for highest charges.

The 10 lbs. cartridge for the 65 and 60 cwt. 8" guns, and the 10 lbs. cartridge for the 58 and 56 cwt. 32-pr. gun, are marked D. (distant) to show they are not to be used for lighter guns of these calibres.

Cartridges not filled by the R.A. have the monogram of the station at which they were filled marked on them.

For charges for various guns and packing, see table, pages 300, 304.

The following are approximate rules for the ratio of weight of charge to weight of projectile :—\*

Shot guns, service charge from  $\frac{1}{3}$  to  $\frac{1}{4}$  weight of projectile.

Shell guns,  $\frac{1}{8}$ th to  $\frac{1}{12}$ th.

Carronades,  $\frac{1}{12}$ th.

The 5 lbs. charge for the 8" gun is too short for the chamber, and is brought up to length by a coal dust wad contained in a blue serge bag.

Serge bags are used for containing 10 or 15 lbs. of loose powder or less for filling shell.

Cartridges are issued filled to the navy and empty to the artillery, **Issue.** except for field service, when they are issued either empty or filled according to circumstances; the filled cartridges for field service are issued in gun ammunition boxes. Empty cartridges are made up in bales pressed together by hydraulic pressure, covered with oiled canvas, and outside with stout Hessian stitched together. It may be remarked that the cartridges are not nearly so liable to be attacked by moths as long as the bales are unopened.†

The bales are marked with the nature of cartridge, weight of charge, number of cartridges, and date.

*Cartridges, Silk Cloth*, are used for blank charges, as they are not so liable to carry fire as serge; they would be used whenever a gun has to be loaded again after firing a blank charge, unless a long interval of time should intervene, as in the case of morning, mid-day, and evening guns; they diminish the risk of firing blank charges. **Cartridges, silk cloth.** §§ 1780, 1868.

The rule laid down is that silk cartridges are to be used, (1), saluting where the number of guns is less than the number of rounds fired; (2), where garrison guns are allowed to be fired at reviews by special order; (3), for exercise in dismissing recruits. § 1829.

Silk cartridges are at present made up for all S.B. guns, except the 100-pr. and 3-pr.

They are choked and hooped with silk.

*Drill Cartridges* are hollow blocks of wood, covered with raw hide and fitted at one end with an imitation choke and rope handle; they are marked like the service cartridge, which they are intended to represent. **Drill cartridges.**

"*Gauges, filled Cartridge Brass Ring*" are made of 14 different sizes. The gauge is a gun-metal ring with a handle, on which is stamped the nature and size. They are used in the examination and making up of filled cartridges, over which they should pass freely. **Gauges, filled cartridge.** § 1695.

Loose, in numbers, as demanded.

	Diameter, inches.	<b>Issue.</b>
100-pr. gun	8.25	
10-inch gun and howitzer, and 68-pr. gun	7.76	
8 " and 56-pr. guns	7.2	
8 " howitzer and 42-pr. gun	6.67	
32-pr. gun	6.09	
24 " "	5.52	
5½-inch and 24-pr. howitzer	5.1	
18-pr. gun	5.02	
32 " howitzer and 12-pr. gun	4.39	
12 " "	4.2	
9 " gun	4.02	
6 " "	3.5	
3 " "	2.78	
4½-inch howitzer	2.2	

\* Reduced charges used when firing at angles of depression; half charge from 15° to 30°; quarter from 30° to 50°, in order not to dismount the pieces.

† The Navy carry a certain proportion of empty cartridges, except for boat guns.



## CHAPTER X. — INTRODUCTION TO AMMUNITION FOR RIFLED ORDNANCE.

THE great advantages resulting from the use of elongated projectiles fired out of rifled guns have for some time been duly recognised, and accordingly steps have been taken by all civilized nations to ascertain experimentally the system of rifling best adapted for the various requirements of field, garrison, and naval guns.

The two systems of rifling best known among European nations are:—

- (1.) A breech-loading system, using a soft-coated projectile slightly larger than the bore of the gun, which is forced by the explosion of the charge to take the rifling, which usually consists of a large number of shallow grooves cut spirally in the gun: for example, the Armstrong and the Prussian systems.
- (2.) A muzzle-loading system, using projectiles with studs or ribs, shaped to the same general form as the spiral grooves in the gun, but with sufficient play to allow of facility and celerity of loading: for example, the British R.M.L. field guns and Woolwich guns, which are modifications of what has been called the French system.

The principal object aimed at in these or in any other system of rifling is to "centre" the projectile in the gun, and to give the projectile sufficient spin to ensure its travelling approximately *point first* throughout the entire range.

By this means the resistance of the air to an elongated projectile of given weight is greatly reduced, and a higher velocity is maintained at all ranges, higher than in the case of a spherical projectile fired under similar circumstances: hence result greater accuracy, harder hitting, a flatter trajectory, and greater penetration.

Other collateral advantages arising from the construction of an elongated projectile must also be mentioned, (1.) the head may have any shape according to the purpose for which it is required, *e.g.*, if penetration is required, the head may be pointed and made ogival. (2.) The capacity of the projectile for powder or bullets is increased. (3.) Percussion fuzes may be made of a more simple character, as it is only necessary to provide for action in one direction. (4.) The weight of the various projectiles fired out of the same gun may be assimilated by varying the length. (5.) A great saving of powder is effected, *e.g.*, from  $\frac{1}{2}$  to  $\frac{1}{4}$  the weight of projectile instead of  $\frac{1}{2}$  in S.B. guns.

It has been found necessary to protect the bursting charges of powder against the risk of premature explosions arising from the rotation of the shell, either by lacquering the interior of the shell or by placing the powder in a separate case or bag. Red lacquer is now used, but some shell may be found with black lacquer.\*

Lacquering has not been found a sufficient protection to the powder in R.M.L. common shells of 7" and upwards. Serge bags are now used, *see* p. 25, 151.

The bursting charges of common, garrison segment, and Palliser shell and Palliser shot follow the same rule as those for spherical shell, *i.e.*,

\* The black lacquer was discontinued as it was found to cause prematures. Vol. III., Extracts, pp. 143, 240.

the shell are completely filled with powder.\* Shrapnel bursters are to be weighed or measured to ensure their having enough powder. Segment bursters are loosely filled with shell F.G. powder for field service shells. § 1580.

To insure good shooting the projectiles should at least be 2 calibres in length, the length of the projectile will be limited by the twist of the rifling; thus we find that the 12", 25-ton gun, which has an exceptionally slow twist is unable to fire as long projectiles as the other Woolwich guns, consequently its common and Shrapnel shell cannot be brought up to the weight of its Palliser projectiles. Length of projectile.

It is desirable that projectiles for the same gun should approximate to the same weight, as otherwise range tables would vary with the different projectiles when the same charges are used.

Case shot for all rifled guns under 7" inclusive is to weigh about  $\frac{3}{4}$  the service projectile. For guns over 7", case is to weigh the same as a spherical shot of the same calibre, one or two may be used according to distance. In loading case, the iron handle is to be away from the charge. Case shot.

All rifled common shell of 64 lbs. and upwards made between March, 1869, and February, 1873, have unloading holes, closed with gun metal-plugs and papier mâché wads in the head. These holes are used in unloading the shell when it is found difficult to extract the percussion fuze. Experience has shown that the unloading hole was very rarely of use, and to simplify manufacture it has been discontinued. If there is any difficulty in extracting the fuze, the shell may be fired from a gun, or thrown into the sea, or otherwise safely disposed of.† §§ 1764, 2426.

Projectiles for rifled guns are painted black. The heads, however, of the field service Shrapnel are painted red, and the tips of the Palliser shell are painted white. The lead coating of B.L. projectiles is left unpainted, except about half an inch over the lead at either end of the projectile; for instructions as to painting see Cl. 81, 115, Army Circulars, 1868, and table of paints, p. 297, 293. Paint.

Grummet wads are supplied on special demand for use when firing rifled projectiles at angles of depression. Grummet wads.

At practice when it is not desired to burst the shells, blowing charges are to be used. § 1973.

7"	-	-	-	-	6 oz.
64-pr.	-	-	-	-	4 "

Blowing charges.  
§ 2099.

A calico bag made with a neck to fit the fuze-hole will be used, the shell is first to be filled with dry coal dust, leaving a space for the blowing charge; the bag will be inserted and filled with the proper charge of powder, and the wooden time-fuze will then be driven firmly into the fuze-hole. Blowing charges for the larger natures of shell are given in § 2099, but the use of time-fuzes has been discontinued with these shells.

As the shot from rifled guns always strikes point first the arrangement of percussion fuzes is much simplified; even the ordinary time-fuze will act percussively if the shell strikes a solid obstacle. The arrangement of Shrapnel shells is improved, the powder chamber being

---

\* When rifled common shells are fired at practice as blind shells, the gun-metal plug is to be removed and returned to store, a wooden plug, supplied on demand, being substituted for it. The shell is to be filled with a mixture of sand and sawdust, or any similar material available, to make an equivalent weight to the bursting charge. § 2089.

Shell so issued from Woolwich are stencilled "sand" in white, and are marked with a yellow band.

† With large shells the method given in the Appendix, p. 283, may be followed. A shell thus treated is unserviceable.

placed behind the balls. The best form\* and material of head can be used for the special purpose for which the shell may be intended; thus in the Palliser projectiles the head is much harder than the body, the latter having greater tenacity. All projectiles, hollow or solid, can be brought to the same weight for the same gun, or if wished, specially heavy projectiles can be used.

§§ 1126, 1162, 1545. In all ammunition for rifled guns the pattern or mark is shown by a Roman numeral; this is important, as by quoting the numeral the nature of store in a fort or field battery can be identified.†

Issue. As a general rule it will be found that common and segment shell of the garrison calibres are issued loose whether filled or empty, the F.S. calibres are issued loose when empty, except for transit to India when they are boxed, and boxed when filled.‡

Shrapnel shells are generally issued boxed.‡

Case shot are issued loose when made of iron, and boxed when made of tin plate.§

Cl. 95, A.C., 1872. It is desirable when practicable to store Shrapnel shell under cover, they should never be kept standing on their bases when exposed to the weather.

Projectiles should not be stacked in contact with the ground, but a base should be formed of old shot or shell.

§ 2206. A plank is issued to facilitate stacking projectiles, it is made of elm, Cl. 58, A.C., 1872. is 7 feet in length, and bevelled off at one end; it is bound near the ends by two iron bands. A tray for raising projectiles is issued to wharfs where there are cranes.

Clip for lifting rifled M.L. projectiles from 7-in. to 12-inch (Mark I.) § 2418. A pattern of this clip has been sealed to govern supplies. See p. 97. The studs on the inside of the arms fit into the extracting holes in the head of the projectiles, and are retained in their place by the screw-bolt which passes through both arms.

The common and segment shell above the F.S. calibres have a gun-metal bush screwed into the fuze-hole of the shells; this is necessary when shells are kept filled and fuzed with a metal percussion fuze, as otherwise the fuze would become fixed in the fuze-hole by rust. The bush is countersunk in the later patterns about  $\frac{1}{2}$  inch;¶ this protects the fuze and also allows room for the wads used in the navy.

\* The ogival form of head has been found the best, both for overcoming the resistance of the air and for penetrating armour plates. The heads of Woolwich projectiles of recent manufacture are struck with a radius of  $1\frac{1}{2}$  the calibres, for example, the head of a 10" projectile would be struck with a radius of 15". Shrapnel have a head struck with a radius of 1 calibre.

† The system of marking commenced in January 1866. In 1867 the word "mark" was directed to be substituted for "pattern." § 1545 states "consecutive numerals will still be applied to stores on every change of manufacture, but these are to be considered merely for the purpose of identification; and while therefore they should be quoted in all reports having reference to any particular store, they are not to be quoted in demands for stores, except in the few cases that may arise which may call for special supply to suit the existing store at the station. It is to be understood that no store becomes obsolete by the mere introduction of a later pattern. The condemnation of stores as obsolete will always be followed by their withdrawal on specific orders to that effect."

In some cases, however, marks are not interchangeable: thus, in demanding R.L. percussion fuzes for a 64-pr. R.M.L. gun, Mark II. should be demanded.

‡ Rifled projectiles used to be issued in jute bags, but this practice was discontinued in 1871. Grummets are to be attached to studded projectiles issued to naval stations where there is no controller. So far as present experience goes the studs do not suffer any material injury in transit when unprotected.

§ In future (March 1874) the iron of which the envelopes of the larger natures of case shot is made will be tinned. The term tin is limited to thin sheets of wrought-iron brought to a high polish and coated with tin. Tin sheet for case shot is obtained by contract, the thickness being regulated by the trade mark or brand. Tinned iron has not the brilliant surface of tinned plate.

¶ In the 40-pr. R.M.L. common shell the socket is flush.

## CLIP, LIFTING R.M.L. PROJECTILES.

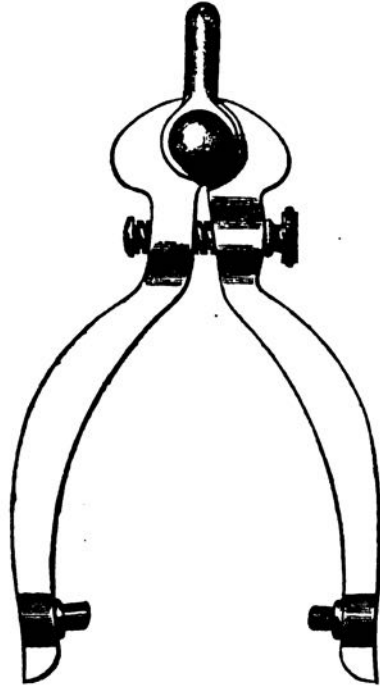

Empty shell having a bush, as above, are issued to the navy with a §§ 1346, 2370, "wad, papier mâché, fuze-hole, naval, plain" painted blue, placed over 2421. the plug; this wad serves to protect the plug from wet.

Filled shell are issued to the navy fuzed with the Pettman G.S. per- §§ 2370, 2413, cussion fuze, and having a "wad, papier mâché, fuze-hole, naval, with 2421. loop" cemented in over the fuze, with red cement. Shell with the fuze protected in this way have been placed for a day under water without injury to the fuze.\*

The filled shell can readily be distinguished from the empty ones in the dark by the loop on the wad.

Experiments carried on at Shoeburyness in February 1869 proved that filled and plugged shell were exploded when struck by a Palliser shell. (A 9" Palliser shell was used with a striking velocity equivalent to that due to a battering charge at a range of 1,000 yards; the shell fired at were 9" common shell.) Great destruction was caused in the casemate by the explosion.

The Committee concluded:—

- (1.) That it is absolutely necessary to provide magazines proof against horizontal as well as vertical fire for storing shells.
- (2.) That when shells are brought into the batteries for use, the greatest care should be taken to place them in positions where they may be secure from the danger which attends their exposure either to direct fire or to the impact of fragments of burst shells.

In May 1870 further experiments were carried on by firing 9" Palliser shells, with a striking velocity equivalent to that due to a battering

\* Directions for fixing:—

1. The edge of the wad is to be well covered all round with cement.
2. The wad is to be driven well into the recess over the fuze.
3. The cement is then to be spread over the whole surface of the wad and round the edge, putting it also on the rivet and under the loop.

N.B.—The cement must be well stirred before it is used, and if it has become too thick a little spirits of wine must be added.

33683.

G

§ 2370.

charge at a range of 200 yards, at filled Palliser shells and filled common shells fuze with the Pettman G.S. fuze, placed behind a "Warrior" target ( $4\frac{1}{2}$ " of iron, 18" of wood). Both common and Palliser shell were exploded; in several cases the fuze of the exploded common shell was recovered and found not to have fired.

The Committee concluded:—

- (1.) That the circumstance of filled shell being fuze does not render them more liable to be exploded by a shell striking them than if they had been only filled and plugged.
- (2.) That the best method of diminishing the havoc arising from a shell striking or bursting among rows of shell placed behind the bulwarks of an iron-clad ship is to place live and empty shell alternately, an arrangement which apparently confines the explosion to the shell actually struck.

§§ 1349, 1880. As a general rule all filled shell have the word "filled" stencilled on them in red. Shell which have their bursting charges contained in bags have the word "bag" stencilled on in addition to the word "filled." Shell filled in an arsenal would also have the date of filling and the monogram of the station. F.S. shells filled in an arsenal would be marked in accordance with the above rule, but when the shell are issued empty and filled by the battery this mark would not be found; all shells carried in the limbers and wagons are filled, so the mark is only of use when shell are returned into store.\*

Stencil plate,  
filled shell.  
§ 2204.

G.S. plug.  
Drill plug,  
G.S., with  
lanyard.  
§ 2090.

B.L. field  
service plug.

Moorsom  
gauge plug.

Primers,  
Shrapnel shell.

§ 1395.

§ 1975 and  
errata. 1/1/71.

A stencil plate for marking shells "filled" has been sealed for issue.

The G.S. plug is used with all rifled shells except the B.L. field service segment and common shells; it is a conical plug with no shoulder, having a square hole in its head to take the G.S. keys, p. 56. A G.S. plug with lanyard attached is issued for unloading field service R.M.L. shells at drill.

The B.L. field service plug is used only with the 6, 9, 12, and 20-pr. F.S. common and segment shells; it has a shoulder and may also be easily known by having a coarse left-handed screw thread. The 20-pr. plug has a loop† attached to it. Leather collars are issued with these plugs, and 5 per cent. spare are issued to field batteries.

The Moorsom gauge may still be found in some B.L. shells. The large plug with a cylindrical body is easily recognised. The shells are to be converted to the G.S. gauge by fixing in an adapter. See p. 103.

*Primers, Shrapnel Shell.*—In shrapnel shell a primer is used; it serves to convey the flash from the fuze to the powder, and also prevents the powder from working up into the fuze socket.

For method of fixing it in the shell, see p. 52.

Mark I. primer consisted of a metal cylinder tapped to screw into the pipe of the shell, the bottom was solid, pierced with a fire-hole, the top was open. It contained mealed powder, driven and pierced like a tube.

This construction was found defective as the flash had a tendency to pass upwards, and blind shell frequently occurred when it was used.

\* In 1868 experiments were carried out which showed that it was safer to carry the F.S. shell filled in the limbers than to carry the bursting charges separately in bags. The bags were therefore returned into store and the shell carried filled. Extracts, Vol. VI., p. 104, also § 1581, Changes in War Stores.

† All the plugs had loops but they were ordered to be cut off except the 20-pr.



Mark II. primer was introduced to remedy the defect.

§ 2268.

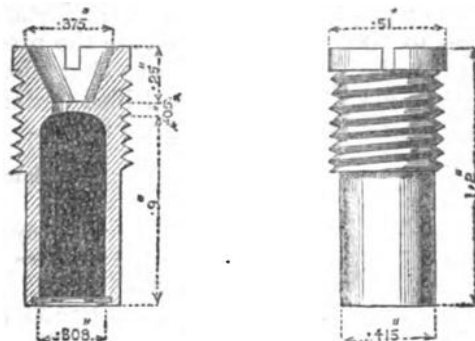

The top of this primer is solid, with a conical cup-shaped recess; the bottom of the cup is perforated with three small holes, communicating with loose powder, with which the body of the primer is filled. The bottom is closed by a thin annular disc covered with shalloon.

There are two slots in the head for the screw-driver. Mark I. had four slots, and in unscrewing a tight primer the head was apt to give under the screw-driver.

Mark II. is found to act well. Mark I. primers are to be returned § 2521. except those fixed in shell.

Primers are issued in a tin cylinder holding 10, closed by a tin band.

The proportions of ammunition for rifled guns supplied to garrison batteries of the R.A. for practice will be found in the Appendix to C. 54, A.C., 1873.

---

## CHAPTER XI. — AMMUNITION FOR ARMSTRONG BREECH-LOADING GUNS.

---

SEGMENT, COMMON, AND SHRAPNEL SHELL.—GAUGES.—CASE, SOLID, AND DRILL SHOT.—CARTRIDGES, AND MISCELLANEOUS STORES CONNECTED WITH THEM.

---

The systems of rifling now in the service are as follows :—

1. Breech-loading, Armstrong, polygrooved.
2. Muzzle-loading, Armstrong, shunt.
3. „ „ Woolwich.
4. „ „ French.

### ARMSTRONG BREECH-LOADING SYSTEM.

The Armstrong breech-loading system adopted for the service in 1858, comprises 7-inch, 40-pr., 20-pr., 12, 9, and 6-prs., in each of which the breech is closed by a vent-piece supported by a breech screw, and the 6½-pr. and 40-pr. guns, which are closed by a stopper and wedge. The different methods of closing the breech only affect laboratory stores to a very limited extent, as will appear hereafter.

In the Armstrong B.L. system a soft-coated projectile is forced through a polygrooved bore of such diameter that it can only receive it by the lands cutting their way into the soft coat.

Calibre of  
Armstrong  
guns.

The calibres of Armstrong guns are the diameters taken at the smallest part of the bore immediately in front of the seat of the shot; this part is called the "grip," it extends a short distance up the bore, which then enlarges to  $\cdot 005$  inch, so as to ease the projectile.

The dimensions of the powder chamber, shot chamber, grip, and barrel will be found in the "Text Book of Rifled Ordnance," p. 61.

The calibres and twist of rifling of the guns are :—

		Diameters of Shell.			
		Calibre.	Twist.	Body.	Back end.
7 inch	-	7 inch	Uniform 1 in 37 cal.	7·036 in.	7·0875 in.
6½-pr.	-	6·4 "	" 1 in 40 "	6·433 "	6·4875 "
40 "	-	4·75,"	" 1 in 36½,"	4·78 "	4·835 "
20 "	-	3·75,"	" 1 in 38 "	3·78 "	3·841 "
12 "	-	3·0 "	" 1 in 38 "	3·029 "	3·0705 "
9 "	-	3·0 "	" 1 in 38 "	3·029 "	3·0705 "
6 "	-	2·5 "	" 1 in 30 "	2·531 "	2·5705 "

From the above dimensions it will be seen that the compression undergone by the shell at the grip varies from  $\cdot 09$  inch in the 20-pr. to about  $\cdot 07$  in the 12-pr.

The twist is in all cases rapid and uniform.

Windage is done away with, hence the accuracy is great, the projectile is detained in the bore until the force of the powder is more fully developed than where there is less initial resistance.

The absence of windage entails the necessity of a percussion arrangement for igniting the time fuzes; a considerable amount of force must be expended in overcoming friction in the bore, but there is a great advantage in the gun being preserved from "guttering," *i.e.*, the destructive action of the gas rushing over the projectile, and also in the shot being properly centered, which accounts to some extent for the great accuracy of B.L. guns.

The soft coating is a disadvantage where penetration into iron plates is required, probably it increases the friction.

As might have been expected, this system has been more successful with the smaller calibres than the larger, where the great difficulty of closing the breech effectually becomes aggravated by a system which saves powder at the expense of increased strain on the gun; this question has affected the ammunition considerably, for it has been found necessary in some cases to reduce the weight both of the projectile and charge.

It will be seen hereafter that the opposite plan has been adopted in the large muzzle-loading guns where the projectile is allowed to move directly forward at first, and rotation is gradually impressed on it after the gun has become relieved of the initial strain due to the inertia of the projectile, this being done at the expense of an increased charge of powder, since the gas presses on the shot in inverse ratio to the volume of the space in which it is generated (*i.e.* the portion of the bore behind the shot), and the same object is still further carried out by the employment of pebble powder, which consumes more slowly than the powder used in the breech-loading guns.

There are certain advantages connected with the service of all breech-loading guns, which scarcely belong to this course, that of enabling any unconsumed matter left in the bore after firing to be readily seen, should, however, be mentioned; this especially applies to blank firing.

It is due to the breech-loaders to notice particularly the great accuracy mentioned above, which at the time of their introduction insured such good results in practice, that deficiencies or faults which might otherwise have been obvious to many were so little allowed to exist, that for some time one single projectile (the segment shell) was held to be efficient as shot, common shell, Shrapnel, and case.

The projectiles that are now in the service in connection with this system are as follows:—

- A. Shell.
- B. Shot.

A.—*Shell.*

- 1. Segment Shell.
- 2. Common „
- 3. Shrapnel „ (Boxer's).

1. *Segment shell* (calibres, 7-inch, 40-pr., 20-pr., 12-pr., 9-pr., and 6-pr.) consists of a very thin cast-iron cylindro-conoidal shell, lined with cast-iron segments, built up in layers, having a cylindrical powder chamber in the centre. The base is closed with a cast-iron disc.\*

A thin coat of an alloy of lead extends from base to shoulder; the alloy also flows in between the segments and lines the powder chamber, giving great weight and solidity. The lead flows over a recess in the base of the iron disc which forms the bottom of the shell, thus retaining it in its place. The thick rim of lead at the base is the most certain way of distinguishing segment from common shell, which they closely resemble externally.

The head has been struck with various radii; the curve will be found generally more abrupt than that employed in common shell. Some are finished off with a nozzle.

The shell is strong against external pressure, while a small bursting charge opens it.

The coat (generally termed the lead coat) was at first made of the following alloy:—8 parts soft lead to 1 part antimonial lead, and 2 parts tin; but in June 1862 this was superseded by an alloy of 19 parts lead to 1 of antimony on the score of economy.

§ 543. Lead coating.

The lead coating is .05" deep over body, and .1" over base, a can-nelure running round the shell to take any lead stripping off the front part.

The increased diameter at base is intended—

- 1st. To prevent windage.
- 2nd. To enable the projectile to be gripped simultaneously at shoulder and base on ramming home.
- 3rd. To retain the grip until the base leaves the muzzle.

Uncoated portions (head and bottom) are painted black, the paint extending over the edge of the lead to prevent corrosion, &c.; one coat of common paint and one of Brunswick black being used.

The lead coat has been attached in three ways:—

- 1st. By tin solder and square cut grooves in the shell. This stripped very much. Attachment. § 271.
- 2nd. By mechanical means, viz., undercut grooves. This was better. § 330.
- 3rd. By zinc solder, no grooves.

\* Very few 64-pr. segment shells have been made; they were issued to Canada, and it is possible that they have all been expended or returned to Woolwich.

The zinc amalgamates sufficiently with the iron and lead to give a very complete attachment. To compensate for the absence of grooves on the outside of shells with zinc attachment, similar grooves are cast on the inside.

The 7-inch and 9-pr. have also grooves running round the outside of the base and inside edge of the body; that is, in the surfaces of base and body which are in contact, for the lead to enter and seal up the joint.

Every segment shell has four longitudinal grooves in the interior of the head.

Classes.

Segment shells are of two classes :—

1. Garrison or naval.
2. Field or boat.

Class 1.

*Garrison or Naval.*—7-inch and '40-pr. gauge, G.S.\* Fuzes, 9 seconds or 20 seconds, B.L., and Pettman's G.S. and R.L. Screw, Mark II. percussion.

§ 1120.

These shells have their powder chambers coated with red lacquer (see p. 298) in order to prevent premature explosions.† Originally

§ 2621.

40-PR. SEGMENT SHELL (WITH MARK I. ADAPTER).

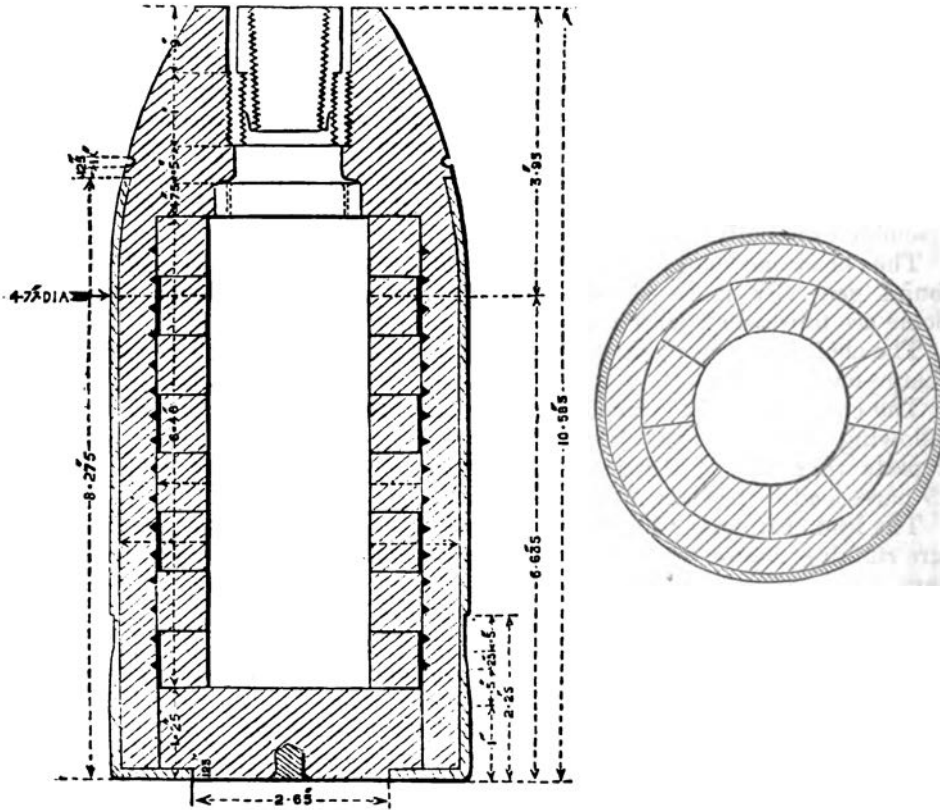

\* The Pettman G.S. fuze would answer well when the segment shell is used against wooden ships or against troops behind a thin wall or parapet, but for troops in the open, a fuze which acts on graze like the R.L. Screw percussion, Mark II., is required. The latter fuze answers well with the B.L. guns, so far as some limited trials show.

§ 492.

† Black lacquer, consisting of coal tar and pitch, was found to fail; it was generally rough and apt to become detached from the shell, as the lacquer melted in hot weather, even when shell were exposed to a hot sun in England. For prematures ascribed to this cause, see p. 25, also Extracts, O.S.C., Vol. III., pp. 142 and 240. Many shell exist which have black lacquer. See Table of Patterns, p. 113.

these shells were made with a gun-metal bush of the Moorsom gauge, now obsolete; they are now issued with an adapter screwed in and permanently secured,\* converting them to the G.S. gauge, *see* p. 16. § 1427.

For weight, bursting charge, dimensions, &c. of shell, *see* table, p. 113. The length approximates to a little over two calibres.

For filling and securing shell, *see* p. 51.

Shells filled in the R.L. are marked as given on p. 98.

Empty, loose for garrison service.

Issue.

Filled and fuzeed with Pettman G.S. fuze, and issued loose for S.S. § 1089.  
*See* p. 97.

**Field Service Segment Shell.**—Field service gauge,† Fuze B.L. plain percussion (navy, E. time in addition) calibres, 20, 12, 9, and 6-prs. In the shells the powder “shell F.G.” is contained in wrought-iron gas pipe bursters, the pipe is dropped into the powder chamber, which is of the same diameter as the fuze-hole, the brown paper cover in which the burster is issued is retained, the top end being torn off to allow ignition, the ends of the burster are closed by serge and paper discs fastened to metal rings.† *See* plate, p. 330. § 1954.

Class 2.  
Field service  
segment shell.  
§ 754.

§ 1954.

\* “Apply a coating of red lead to the screw part of the adapter, and screw it home. After screwing the adapter into rifled shells, fill the space between the plain part of the adapter and the nose of the shell with the following composition:—

Rosin	-	-	-	12 lbs.
Spanish brown	-	-	-	2 „
Plaster of Paris	-	-	-	1 lb.
Turpentine	-	-	-	$\frac{1}{2}$ pint.

The composition should be poured in whilst very hot, a plug of wood being fitted into the adapter to prevent any of the composition running inside. No special tools are required.”

† As the field-service gauge is tapped with a coarse quick screw the plugs are apt to unscrew from the jolting of the limber, care must be taken to examine the plugs frequently, and to screw up any that have become unscrewed. The thread is left-handed.

‡ The present pattern is Mark I.; the 6-pr. burster is of cast iron, and smaller at the bottom to fit the chamber which contracts at the base. B.P. or B.C. on the burster shows that it is of a proper length for the brass percussion fuze, which used at first to be called concussion.

In 1865 the present pattern of bursters, Mark I., was introduced and bursters of former patterns were ordered to be returned. § 1115.

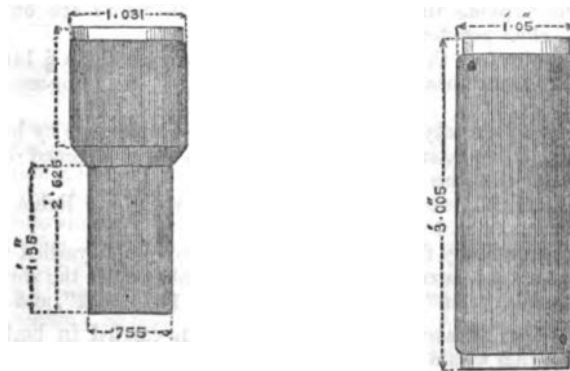

In 1868 it was ordered that the powder of the bursting charge in these bursters should not be shaken down as previously directed, it having been found to cake and § 1580.



Field service shells are now carried filled, over the burster is placed a wooden plug covered with serge to keep it from shaking about, the B.L. field service gun-metal plug with leather collar (no loop at present, except 20-pr.) is then screwed in.

To prepare the shell for firing, the gun-metal plug is unscrewed, the serge covered plug taken out, and the fuze dropped in rim to the front; the safety pin being withdrawn (in most segment shells it is impossible to put the fuze in wrong as the rim comes in the way), the gun metal plug is again screwed in. Since the use of the time-fuze has been discontinued it has been found necessary to insert a lead disc at the bottom of the shell to keep the percussion fuze from having play in the shell, owing to the screw thread in the gun-metal plugs being shorter than the time-fuze. Shell which have these discs permanently fastened in are marked with the letter D on the lead coat. This does not apply to shells for S.S.

§ 1981.

§ 2028.  
§ 2050.

Issue.

These shells are about 2 calibres long. For weights, &c., see p. 113.

1st. Filled and boxed for S.S.

2nd. Empty, loose for transit, or filled and boxed, for F.S. If issued empty, they are filled before placing them in the limbers.

Issue of  
bursters.

Bursters are wrapped singly in brown paper, and packed in No. 6 packing case for Laboratory stores; in the following numbers, or less: 20-pr., 72; 12-pr., 88; 9-pr., 120; 6-pr., 154.

Distinctive  
marks on B.L.  
projectiles.

With reference to distinctive marks indicating the peculiarities of each pattern, the most important is the numeral (*vide* p. 96). This is stamped on the coat of B.L. projectiles made since the commencement of 1866.

Very large numbers of shells, however, will be found without any numeral, having been made previous to this date, and many of a pattern previous to that identified by Mark I.

As a rule, shells made at Elswick are marked on the heads, and Laboratory made shells on the bases; both may carry marks on the coats.†

§ 601.

Shells for the service were at first made by the Elswick Ordnance Company. Such shells are generally marked E OC on the head, and if passed by the Inspector of Artillery, I  $\uparrow$  A † on the coat, besides the marks agreeing with the sealed pattern.

Shells made in the Royal Laboratory have R L on the base, and generally Z, indicating zinc attachment. A few have Z on the coat.

sometimes fail to explode the shell; the bursters therefore are only to be filled loosely with F.G. shell powder.

The method of altering the old pattern bursters is given in § 1464, but as this was approved in 1867 and has since been carried out it is unnecessary to give the details.

The proper pattern is easily known from those made obsolete by having the ends secured by serge and paper, and by having the brass ends fastened in by punching three indentations in the iron tubing.

The bursters which had their ends closed with a wad were liable to cause blind shells.

Bursters are occasionally found to leak; this may be remedied as a temporary measure by inserting the burster in the shell, or, if already in the shell, by reversing it. The 6-pr. burster is 2.6" long, the 9-pr. 3", the 12-pr. 4.2", and the 20-pr. 5.3".

§ 1581.

\* These shell must be assumed to be filled when carried in limbers. Batteries equipped at Woolwich would have the shell filled and marked in accordance with rule, p. 98. For transit to India the shell would be issued "Empty, boxed."

† Some E OC shell, re-leaded in the Royal Laboratory, carry Laboratory marks on their coats.

‡ Some shells of very early manufacture have  $\uparrow$  only.

U on a lead coat signifies the undercut method of attachment, but § 669. many of the undercut shells (especially 20-pr. segment) and all shells with tin attachment are without any mark of this kind.

Shells with the lead and antimony coating, made in the Royal Laboratory, are marked  in the cannellure, a few have been made at

Elswick with the same coating, but there is no mark to indicate this.

*Marks which should be on coats are frequently found deficient.*

All shells with I  A on the coat may be assumed to have lead and tin coats (the attachment may be tin, undercut, or zinc).

Segment shells are very effective against troops in column, and <sup>Use.</sup> should be burst close to them. A percussion fuze which acts on graze is necessary; the Dartmoor experiments showed that a time fuze was nearly useless with a F.S. segment shell. When the ground is favourable and hard enough to make a percussion fuze act the effect would probably be very great. It is necessary to burst the shells close to the object, as they scatter very much, also the shape of the segments is unfavourable to flight. Segment shells have given good results when used against troops behind a thin wall, the shell bursting just as it passed through proved very destructive; the larger calibres would probably be effective against wooden ships. The distance up to which segment shell is effective will vary with the gun, the 12-pr. gun gave very good results at about 1,700 yards at Dartmoor, (10 rounds gave 1,194 hits on targets in column at 1,670 yards, bursting within 10 feet of the targets,) and no doubt would be effective up to 2,000 yards. Beyond 2,000 yards their destructive effect would probably diminish rapidly; from garrison guns the effective range would of course be greater.

## EXPERIENCE WITH SEGMENT SHELL.

### *Shooting on Active Service.*

Most of the reports on the segment shell in active service have been favourable.

In New Zealand it was spoken of as very valuable in searching out men in rifle pits.\*

---

\* Extracts from Report of Capt. Mercer, R.A., to D.A.G., R.A., 6/4/61. See R.A.I. Proceedings, Vol. II., page 393:—

“The guns were loaded and laid, and the gunners with lanyard in hand waited for the word from the officer, who was watching until some heads appeared above in that direction, or a puff of smoke revealed their presence, when the gun was instantly fired, and the shell, entering just below the crest of their pits, burst inside.

“The following evidence has been given concerning the action of the Armstrong shell with the concussion fuze (*i.e.*, percussion fuze) only:—Colour-Serjeant J. Morant, Royal Engineers, was at the head of the sap, and saw an Armstrong shell go through a rifle pit, about four feet of earth, and burst inside, and heard the enemy shout as in pain; he also observed that the shell from the Armstrong gun entered the rifle pits as soon or sooner than the report was heard, so that the natives had not time to get out of the way. Bombardier J. Singer, No. 3 battery, 12th brigade, R.A., was at the head of the sap, and in the advance parallel with the Coehorn mortars, when he saw several shell from the Armstrong gun go through the enemy's rifle pits and burst inside. After the cessation of hostilities one of the natives told my serjeant-major that they were sometimes able to get out of the way of the mortar or large shells, but never out of the way of the shell (whether with time and concussion, or

In China it was especially praised for its action when fired with percussion fuzes to burst through brickwork.\*

concussion fuze only) from the gun 'all the same as the rifle,' meaning the Armstrong guns, as the shell was amongst them as soon as they heard the report. These natives have designated the Armstrong shell 'the quick shell.'

"The different statements made both by those who were in the sap as well as by the natives themselves corroborate the observations taken from the battery, viz., that the Armstrong shell with concussion fuze only entered the crest of the enemy's rifle pits and burst inside; whether there were few or many natives in the pit at the time cannot be ascertained."

*Extracts of Evidence given by Captain Seymour, C.B., R.N., before Armstrong and Whitworth Committee, page 74.*

"Saw the Armstrong guns worked in New Zealand the whole time, and almost every shot that was fired from them.

"I have seen a report by Captain Mercer of the Royal Artillery, who commanded the Armstrong battery, and I am only expressing the feelings of the officers and men of the three regiments of the line and of the naval brigade engaged there when I say that we by no means concur in Captain Mercer's statement in his report. We were all most anxious for the success of the Armstrong principle; we had also heard of what it had done in China, but I cannot say that the practice was as satisfactory as we hoped it would have been, I mean from the 12-pr. 8 cwt. guns. Captain Mercer succeeded to a certain extent in driving shell through the earth so as to burst with the concussion fuze inside the rifle pit."

\* *Extracts of Evidence given by Captain R. Harrison, R.E., before Armstrong and Whitworth Committee, p. 69.*

"The shell from the Armstrong guns in China were very destructive. By one shot that was fired at an action that we had near Pekin I think there were as many as 13 killed. It was at a very long range (about 1,500 yards), and there were two or three horses, and, I think, 13 men killed at one single shot. The effect was produced by a segment shell with concussion fuze. It was not hilly ground, but ground dotted over with small jungles and villages, comparatively level; there were deeply sunk roads and gullies here and there. You could see a good deal over the country if you got on the top of a little mound or of a house. The shell struck in a roughish field, not hard ground, it was dryish ground. This one shot was very much noted, because we had been fighting with the Tartars all the day, and they had halted in a place which they thought was quite out of range. Then Sir Hope Grant said he wanted to try the effect of one shot at them, and he ordered one gun to be fired, and the effect was very striking. Everybody was surprised, and the Tartars particularly so. There was a large body of 500, I should think, and it completely dispersed them. That was the most remarkable shot I witnessed against men, and we all noted it. The chief effect that I saw with Armstrong guns was against the village of Tang Ku. That was a large fortified village. The guns were all brought up in line, and at a range of from 1,000 to 1,200 yards, opened against the guns of the enemy. There were about 60 enemy's guns firing on the Armstrong batteries and the other batteries which were brought up in line, and I noted where the Armstrong guns fired. There was a battery of Armstrong's on the right. There were 16 or 18 gunners of the Tartars killed at one gun. The shells hit a small crenelated wall on the top of the parapet, about 3 feet 6 inches high and 1 foot 3 inches to 18 inches in thickness where they burst, and soon all the Chinese gunners were killed. We counted at one gun from 16 to 18 bodies. The effect was very destructive against those men who were concealed behind this parapet. The parapet was just sufficiently thick to explode the shells. We saw where the shell struck the parapet and broke, that the men were all killed by the Armstrong shell. There were some, of course, in the line that were killed by other shell, but the ones that I noted were killed by the Armstrong shell.

"Certainly the Armstrong guns, we all thought, were terribly effective, and they saved a great deal of loss on our side. Photographs were taken showing how the bodies lay about inside. There were an immense number killed by the Armstrong guns. I am quite sure that the great impression in the army was that almost all the effect thus produced on the fort, as well as on the village of Tang Ku, was by the Armstrong guns. I am sure that the wounds were caused by Armstrong guns. I saw the segments of the Armstrong shells lying about just inside the casemates, and the wounds, you could see, were made by them. Sometimes you found a bit in the wound; you cannot mistake the wound."

Its accuracy has been much commended,\* also its range,† these being

\* *Extracts from Captain, now Colonel, Milward's Notes on Armstrong 12-prs. on Service in China, p. 214. Select Committee on Ordnance, 1862.*

"11th August 1860. In action at Singho. The battery fired an average of 18 rounds per gun at 1,200 and 450 yards, besides two shells at 2,100 yards, all with most excellent effect. The concussion fuzes acted admirably; the practice was entirely against cavalry in open order, and quite prevented their forming for a charge, which they attempted more than once. The effect of the shells was all that could be desired. The two fired at 2,100 yards, dispersing a large body of cavalry instantly.

"13th August. Fired 30 rounds per gun, 25 time fuzes, remainder concussion. Time fuzes did not succeed. The concussion fuzes acted well, but one burst in ramming home. No damage to the gun.

"21st August. Capture of Peiho forts. Fired 85 rounds per gun, all with concussion fuzes, making excellent practice at various ranges from 1,600 to 400 yards. The practice at one of the south forts at a range of 1,200 yards was most excellent, several shells in succession bursting on the terreplein of the cavalier. The firing at the north fort at 1,600 yards was also very good, and most effective. Some shells have been picked up only partially burst; generally, I hear (I have only seen one) the bottom half of the shell is unbroken. The concussion fuzes are also liable to suffer from damp, but can be easily repaired if time permits."

*Captain, now Lt.-Col., Hay, R.A., B.M. to R.A. in China. Extracts from his Report to Brigadier-General Crofton, R.A., 6/9/60, p. 216. Select Committee on Ordnance.*

"Those (Armstrong shell) that struck the parapets in places where more than three feet thick, appeared to be blind, whilst the others passed through scattering their segments on the other side.

"On our first advance from Pehtang I assisted in laying the gun on bodies of cavalry, at distances varying from 1,600 yards and upwards, and found that those that burst as desired were most efficient. The same day I had also an opportunity of seeing the gun fired at very long ranges, viz., about 2,700 yards; this was at an enemy retreating at Sinho along a narrow causeway; only one shell that I observed burst at that range; they grazed well. I observed in many instances that the shells had not broken into segments, but had broken in two, or the head or bottom was merely blown out; they (the segments) certainly at present do their work, as, although I found many dead, I never found a man wounded by a segment, they appear to pass right through, stopped by nothing."

Concussion fuzes, a great number were blind. \* \* \* I also observed some premature explosions with them, which must have done some mischief to our troops.

† *Extract from Remarks of Lt. Pickard, R.A., Vol. 4; Proceedings of R.A. Institution, p. 371.*

"From these plans and descriptions two sections were constructed, one of which similar to the pahs constructed in the northern part of the island, consisted of two rows of young trees, or strong spars, about 18 inches in diameter, placed upright side by side from 8 to 10 feet high in the clear, the rows being about 3 feet apart.

"The other description of pah consisted of strong spars about 18 inches in diameter, placed upright in the ground about 8 feet apart; cross bars connected them, and on these were hung smaller spars from 4 inches to 6 inches in diameter; these were placed close to one another, and their ends were kept about a foot above the ground. No nails were used, but as is customary with the natives, flax secured everything. The line of stockading was again double. The natives used to fire out of pits dug out behind the second row, and made deep enough for them to fire under the stockades.

"These latter pahs were used by the southern natives in the war of 1860-61, and on one occasion one 8-inch gun and two 24-pr. howitzers, besides a 9-pr. gun, failed to make a practicable breach in a pah formed as above stated, after two hours' firing, at a distance of 200 yards.

"The battery of six 12-pr. Armstrong's took up a position 900 yards from the stockade, and after rather more than an hour's firing made a breach in the section constructed after the northern fashion large enough to allow a section of men to go through abreast.

"The southern description of pah was more difficult to breach, as it gave more to the shell on bursting; and the debris, supported by the flax, was most difficult to clear away. With both descriptions of pahs, salvoes were found most effective, all the guns being laid on the same part of the stockade, until the posts which seemed to afford most support were destroyed.

"The great accuracy with which these guns could be fired, and the tearing damage



of course exhibited in a marked degree when compared with its spherical predecessors.

Some failures and dangerous accidents occurred with percussion fuzes, and some segment shells failed to open properly (noticed in notes below).

### *Shooting, Home Service.*

Its action has been investigated by the Armstrong and Whitworth Ordnance Select and Dartmoor Committees, this being done in comparison with the Boxer shrapnel shell.\*

It would indeed be difficult to sum up concisely and impartially the results of all these experiments, or to select extracts from the proceedings of the committees; however, the following statements will hardly be contradicted. The shrapnel bullets form a smaller "cone of dispersion," that is, carry much closer than the segments, and hence the shrapnel is effective when burst at a much greater distance in front of the object† than the segment shell; it allows of wider limits of error

---

done by the shells on bursting contributed greatly to effect a breach in the latter description of pah. About two hours were employed in making a practicable breach, and concussion fuzes were chiefly used.

"The guns at Whangamarino then annoyed the Maories at Mere-Mere as much as possible. It was found that the best way to damage canoes at great distances was to fire shells with concussion fuzes, to strike rather short of the canoes, the shell burst on striking the water and the pieces ricocheted forward among the canoes. It was found also that by firing with time fuzes fixed to burst at the extreme range of the fuze, the pieces of the shell all went over 2,600 yards if the gun was laid with about half a degree more elevation than the actual range required. The shells thus fired high in the air, and the pieces being propelled forward and downward went to a great distance.

"When the assault was ordered the rapidity of fire was increased, shells had been prepared in expectation of the assault, and the guns were loaded as fast as they were fired.

"The shells burst beautifully and prevented the Maories taking any aim at the advancing troops, but, when from the near approach of the storming party to the works, the shelling was stopped, the soldiers suffered severely.

"When a long range or great precision is required, the Armstrong shell is most effective, but it would fail if used as a substitute for a howitzer shell in breaching field parapets, and in ricochet fire at short distances."

\* *Vide* extracts from Proceedings of Ordnance Select Committee, report of Armstrong and Whitworth Committee, and report of a Select Committee on Ordnance, House of Commons, reprinted together in 1869.

† *Report of Armstrong and Whitworth Committee given on page VI.*—After a careful consideration of this practice the Committee have to report that when the shells are burst at only 10 yards in front of the targets, the concentration of the fragments with all the guns is greater than is desirable when fired against troops in line, almost the whole effect having been produced in each case upon a front of 18 feet. Where the shells were burst at 25 yards the distribution was better, and the effect of the three guns was about equal when fired against troops in line, but when burst at 50 or 100 yards in front of troops in line, Col. Boxer's shrapnel shell has a marked superiority, due to the bullets maintaining their velocity and direction better than the segments of Sir W. Armstrong's shell.

When fired with the time fuze at columns of troops, the greater penetration of the bullets of Col. Boxer's shrapnel shell make it a much more formidable projectile than Sir W. Armstrong's segment shell.

*Ordnance Select Committee Report, No. 4,190, Minute 18,928, 8/6/66*—"The result of this comparison (*i.e.* a comparison of 12-pr. shells burst in air at rows of targets) is much in favour of Col. Boxer's shrapnel shell, in respect to the total number of balls and splinters striking the targets. This is in some measure accounted for by the actual number of segments being less than that of bullets in the proportion of 48 to 70, but making allowance for this, the proportional number is still greater at every distance.

"Reviewing the whole of the experiments with the 12-pr. gun, the Committee are led to the conclusion that if the segments in the segment shell were reduced in size



in setting the fuze,\* the bullets have also a decided advantage in penetration,† and it will hardly be denied that they are a better form for flight and ricochet.

and increased in number to equal the number of bullets in the shrapnel shells, the latter would have no great advantage when burst in air by a time fuze at short distances from a line of troops, but would still possess a material advantage when burst between 20 and 100 yards in advance.

"The foregoing results (i.e. of 64-pr. shells burst through screens placed at varying distances in front of rows of targets) exhibited very marked superiority in the shrapnel shell when burst in the air by a time fuze at a suitable height and at any distance within 200 yards of the targets."

*Ordnance Select Committee, Minute 22,108, Report No. 4,602, 29/5/67.*—Further to elicit the full merits of the shrapnel, a few rounds of each of the M.L. calibre under trial were fired through screens so placed as to burst the shells at distances varying from 250 to 500 yards short of the targets, or in other words, at distances known to be unfavourable to the effect of the shell, although within the limits of variation which might occur in actual service, from the difficulty of accurately judging distances, and the amount of error which may reasonably be expected in elevating the gun, combined with the errors incidental to all time fuzes.

The results of this practice are most satisfactory, and afford conclusive evidence of the formidable nature of the shrapnel shell. It is apparently most effective when burst within 100 yards of the target, and at about 10 feet above the plane, but its efficiency in the larger natures is still retained even when the burst takes place at so great a distance as 300 yards short of the objects, a condition which the Committee believe would not be realised by projectiles constructed on the segment principle.

A further experiment on a small scale was also made in April last, to elicit more fully the relative merits of 7-inch B.L. shells on the shrapnel and segment principle of construction, the special object being to ascertain how far the segment shell would be effective, if the burst did not take place comparatively close up to the object aimed at. On this occasion the shells, both shrapnel and segment, were burst artificially on a wooden screen, placed at 55 yards distance from the front row of targets. Unfortunately it so happened that the two segment shells which struck the screen burst under unfavourable conditions; the results therefore cannot be taken as decisive of the relative merits of the two projectiles; still, the absence of effect from the segment shell shows that the segments are too widely dispersed for efficiency against troops in column, unless the shell be actually burst close up.

The Committee are, therefore, prepared to recommend that, in future manufacture, shrapnel be substituted for segment shell, for 7-inch and 40-pr. B.L. guns.

\* In the Dartmoor experiments on Friday, 18th June 1869, three segment shells bursting from 40 to 45 yards in front of a row of targets, gave altogether only two throughs and one strike.

† *Ordnance Select Committee Report, No. 4,190, Minute 18,928, 8/6/66.*—In respect to penetrative powers, it appears, on examination, that the proportion of bullets, segments, and splinters which penetrated 2-inch deal targets, was as follows:—

	Shrapnel.			Segment.		
	Total Effects.	Through.	Per cent.	Total Effects.	Through.	Per cent.
Bursts by passing through first row of targets - - - - - 4	496	382	0·77	(3 rounds.)		
Burst by passing through the screen				233	110	0·47
15 yards in front of first row - 5	913	696	0·76	549	298	0·54
Do. 55 yards in front - - 5	458	314	0·69	128	60	0·47
Do. 105 yards in front - - 5	258	144	0·56	45	14	0·31

Notwithstanding therefore the less weight of the bullets than of the segments a larger proportion of the former penetrated 2-inch deal boards than of the latter.

On the other hand when bursting quite close on the object, the wide spread of the segments tells well.\*

In short, the action of the Boxer shrapnel is rather adapted to time fuzes, and that of the Armstrong segment to percussion fuzes, exploding close on the object, hence it will generally be found that the defenders of the segment shell advocate the use of the latter description of fuze, and those of the shrapnel the former.†

\* The Committee have to observe that this practice, *i.e.* grazing on sand to act on three rows of targets took place on the level ground at Shoeburyness, which presents more favourable conditions for such practice than would generally be met with on service. It appears from it, that Col. Boxer's shrapnel shell, as fired from Mr. Whitworth's gun, is far inferior to Sir W. Armstrong's segment shell when burst by grazing on the ground, both as to the number of fragments which hit and their distribution, but the Committee observe that, even under the most favourable conditions when burst by grazing more than 50 or 60 yards in front of troops, their effect is comparatively small, thus showing the importance to be attached to a good time fuze, and that it should invariably be used with these shells in the field in combination with the percussion fuze.

Upon reviewing the whole of the practice with Sir W. Armstrong's segment and Col. Boxer's shrapnel shells, and taking into due consideration the fact that the principle of the shrapnel shell is not confined to the form of shell used in the Committee's experiments, but may be applied to any form of projectile, also that the description of fuze best adapted for ricochet practice may be used with it, the Committee are of opinion that the shrapnel shell is the more formidable projectile of the two.

*Vide* Report of Armstrong and Whitworth Committee, Segment shell *v.* Shrapnel.

These results, *i.e.* obtained with percussion fuzes acting on graze at, from 9 to 60 yards in front of targets, show that the segment shell is very considerably the more reliable when burst on graze a very short distance in front of the object aimed at, and confirms the conclusion arrived at in this respect by the Armstrong and Whitworth Committee, although that body on the whole preferred the shrapnel construction.

“In that case, however, (*viz.*, on increasing the number of segments) the effects on graze would be still more in favour of the segment shells, and this is the use to which the Committee contemplate segment shells being principally put on moderately level ground.

“This comparison, *i.e.* of shells bursting on graze at, from 0 to 108 yards in front of a line of targets confirms the conclusion deduced from the 12-pr. practice, *viz.*, that Col. Boxer's shrapnel shells are generally very inefficient when burst with percussion fuzes.

“The 64-pr. segment shell with its present large charge is also very indifferent, unless when quite close up, and absolutely useless when burst on graze at more than 50 yards distance.” *Vide Ordnance Select Committee Report, No. 4,190, Minute 18,928, 8/6/66.*

At Dartmoor, the most wonderful success of the 12-pr. segment was on 2nd July against targets in column, when 10 effective rounds gave 529 throughs, 234 lodges, and 431 strikes; total 1,194. Ranges 1,670 yards. On this occasion every effective shell burst within 10 yards in front of a target.

† “The segment shell should be used only as a percussion shell where the range is unknown; the burst on graze gives a valuable datum to judge by.

“The shrapnel on the contrary should be used when the range is tolerably well ascertained and steady deliberate fire required. The fact of having to judge of the range by the burst in the air rendered it necessary to be deliberate in its use. Rapidity of fire from a single gun may appear to be very important, but the steady and continuous fire of a battery, or of several batteries together, render the difference of a few seconds of time with each individual round of less practical importance.” “Remarks by Gen. Wilmot, commandant of School of Gunnery.” *Vide Ordnance Select Committee Report, No. 4,862, Minute 24,005, 10/1/68, §§ 2, 3, 5, 8, and 2nd of 10 of opinion of (Dartmoor) special Committee on Shrapnel *v.* Segment shell, which deal with this matter, are as follows:—*

It appears to the Committee that the segment shell with the percussion fuze, has, on the whole, given far greater results per effective round, as well as for the total number of rounds fired, than the shrapnel with the wood time, or the segment shell with time and percussion fuzes; and that in the special comparison of the shrapnel with percussion fuze, and segment with percussion fuze, the latter has a superiority.

Considering, therefore, the segment shell when used as a percussion shell and under circumstances favourable for the action of its fuze—such as on columns of

The very serious evil of premature explosion has frequently occurred in segment shells (as at Dartmoor). If the time fuze is not screwed home so as to press on the percussion fuze and burster, premature explosion may follow, and as such accidents occurred at Dartmoor, particularly in independent firing, and especially with one battery, it is difficult to divest oneself of the idea that this may have been one cause, in one instance 9 and another 10 prematures occurring out of 27 rounds.

Since the above was written the Freeth and Dyer fuzes have been withdrawn, owing to their liability to prematures; the only fuze at present used with B.L. segment shell F.S. is the B.L. plain, which is very free from the defect of causing prematures.

#### EXPERIENCE.

##### *Stripping (on active Service).*

Complaints have been made of lead-coated projectiles stripping in such a manner as to render it dangerous to fire over the heads of troops; \* this objection, however, was made against shells with tin attachment, and can hardly apply to undercut or zinc attached shells.

With the zinc, although it is the best method, the coat has occasionally become detached in spots where the lead has risen up into blisters from the formation of gas underneath it.

Such blisters are generally very small, and may be pricked and then hammered down, when they will in no way affect the fitness of the shell

---

infantry, against cavalry, abattis, buildings, &c., to be a most formidable projectile, the Committee are of opinion that as a percussion shell it should be retained in the equipment of field artillery.

On comparing the number of "effective" rounds with the number of rounds fired, it will be seen that the shrapnel has greatly the advantage, in consequence of its fuze being more reliable than that of the segment. The bullets of the shrapnel also range further, and are more destructive at longer distances from the burst than the segments of the segment shell; its fuze, too, is more easily manipulated than the E or F fuzes. Therefore, at unknown distances, and as the rapidity of fire increased, or in other words, the conditions of actual service were approached, the shrapnel proved itself decidedly superior as a *time* shell to the segment, and would still be so were even a perfect time fuze made for the latter. To recapitulate, the Committee attribute the superiority of the shrapnel as a time shell to the two following causes, viz. : I. The greater permissible error in the distance of its burst from the target. II. The great reliability of the wood time fuze. And considering that it is essential in the equipment of any field artillery to have an efficient time shell, they recommend the adoption of the shrapnel for this purpose.

The Committee therefore recommend,—

- 1st. The retention in the service of the segment as a percussion shell, conditional upon a reliable percussion fuze being provided for it.
- 2nd. The introduction of the shrapnel as a time shell, to be used with the Boxer wood time fuze.
- 3rd. That in the future equipment of field artillery, the proportion of shells should be 40 per cent. of shrapnel to 60 per cent. of segment.

\* Capt. F. B. Seymour, R.N., gave the following evidence on this subject to a special committee of the House of Commons on Ordnance, 1862-3. See No. 2300.

On the 6th of March 1862 "out of 14 rounds three shots stripped in such a way as to look more like canister falling on the water than anything I ever saw before. In March 1861, while the force under General Pratt was attacking the Te Are Pa, near the Waitara River, in New Zealand, I was in the advanced sap, when a fire was opened over our heads from an Armstrong gun mounted in a redoubt about 600 yards to our rear; on that occasion also some of the shots stripped, the metal from which fell about the sap in a manner which might have endangered the men at work in the sap and in the trenches."

for service. If left to develop themselves they have been known to attain a large size.\*

As has been noticed before, a place on a shell where the coat is detached is detected by the flat double sound heard on tapping it, instead of the ring that comes from a sound spot; if the detached portion be encircled with a cut made with a chisel, dividing the coat through, it comes away from the shell showing in the case of a zinc attached shell, a yellowish green corroded surface beneath.

\* Mr. Abel, chemist to the War Department, has written a paper on this, with the title "A curious instance of Electrolytic Action."

I gather the following from this paper and from information given me by his assistants, Mr. Brown and Mr. Dent, with reference to the chemical changes occurring on the performance of successive manufacturing operations:—

In order to get a clean metallic surface for the zinc to adhere to the shell is dipped in sal-ammoniac solution, by which means any oxides of iron become converted into chlorides (say according to the following equation:— $\text{FeO} + \text{NH}_4\text{Cl} = \text{Fe Cl} + \text{NH}_3 + \text{HO}$ ), such chloride of iron is probably left in the bath into which the shell is dipped; but any sal-ammoniac adhering to the shell may cause a similar formation of chloride of zinc, in the next operation, which consists in dipping the shell into molten zinc; this chloride has the property of retaining water at a very high temperature, hence a medium is provided for the commencement of voltaic action between the different metals present (suppose the chemical change so brought about to be illustrated by the following equation:— $\text{Zn} + \text{Zn Cl} + \text{HO} = \text{ZnO}, \text{Zn Cl} + \text{H}$ ); the hydrogen so given off forms the blister, and this blister increases gradually if an escape be not provided for the gas.

Mr. Abel has in his possession two shells with curiously large blisters; one blister would nearly cover two half crowns at the present time (September 1870).

(Note by Captain C. O. Browne).

SEGMENT SHELL.—B.L. GUNS.

Calibre, and Mark of Pattern.	Date of Approval.	Changes in War Stores.	Length, inches.	Diameter at Base.	Number and Nature of Segments.	Weight, mean empty.	Approximate bursting Charge.	Gauge of Fuze Hole.	Attachment of Lead Coat.	Marks.			REMARKS.	
										Head.	Coat.	Base.		
7-inch (no Mark)	21/2/61	211, 1116	14.23	7.0875	112, 3.86 oz. each.	97 15	Shell I.G. powder. 3	Moorsom	Tin - Undercut	E. OC. A.	I ↗ A -	E. OC.	Black laquer.	
" Mark I.	30/12/61	405, 1116	13.75	"	"	97 13.4	"	"	Undercut	E. OC. Z. B.	I	"	"	
" Mark I.	2/12/61	405, 1116	14.48	"	"	88 9.1	"	"	Zinc	E. OC. C.	Z, date, and I	"	"	
40-pr. (no Mark)	21/2/61	211, 1116	10.68	4.835	72, 2.47 oz. each.	89 9	0 " 13	"	Tin - Undercut	E. OC. C.	Z, I	R. L.	Red	
" Mark I.	20/12/61	405, 1116	10.62	"	"	88 9.1	"	"	Zinc	E. OC. C.	"	R. L.	Red	
" (no Mark)	30/12/61	405, 1116	10.88	"	"	88 15	"	"	Undercut	E. OC. C.	"	"	Black	
20-pr. (no Mark)	17/12/61	405	8.16	3.841	56, 1.7 oz. each, and 14, 1.06 oz. each.	19 10 1/2	Shell F.G. Armstrong Fd. Service. 700 grs.	Armstrong Fd. Service.	Undercut	E. OC. probably.	I ↗ A.	"	"	"
" Mark I.	9/5/63	784	8.1	"	"	19 10	"	"	Zinc	E. OC. Z. B.	I	"	"	
12-pr. (no Mark)	13/4/60	90	6.82	3.0705	42, 1.33 oz. each.	10 9	650 grs.	"	Tin - Undercut	E. OC. Z. B.	"	"	"	
"	17/2/61	210	6.82	"	42, 1.33 oz. each, and 6, .86 oz. each.	10 8	"	"	Tin, probably.	"	"	"	"	
"	2/12/61	405	6.72	"	"	10 6 1/2	"	"	Undercut	E. OC. Q.	"	"	"	
"	9/5/63	754	6.75	"	"	10 8	"	"	Zinc	"	"	"	"	
" Mark I.	28/10/64	1001	6.75	"	"	10 8 1/2	"	"	"	"	"	"	"	
9-pr. (no Mark)	No record of approval		5.4	"	35, 1.5 oz. each, and 7, 1.2 oz. each.	8 3 1/2	300 grs.	"	Undercut	E. OC. V. Some shell have T.	date, and I.	"	For practice only.	
"	29/5/62	542	5.35	"	"	8 3 1/2	"	"	Zinc	E. OC. V.	"	"	"	
"	9/5/63	754	5.4	"	"	"	"	"	"	"	"	"	"	
" Mark I.	28/10/64	1001	5.4	"	"	8 3 1/2	"	"	"	"	"	"	"	
6-pr. (no Mark)	3/7/61	344	5.0	2.6705	12, 1 oz. each, and 18, 1/2 oz. each.	5 9	200 grs.	"	Tin.	"	"	"	"	
"	2/12/61	405	5.05	"	"	5 6	"	"	Undercut.	E. OC. E.	"	"	"	
" Mark I.	9/5/63	754	5.05	"	"	5 7	"	"	Zinc	"	"	"	"	

\* Br & 602 the following ± limits are allowed in the manufacture of segment shell. 7" 2 lbs., 40-pr. 1 1/2 lbs., 20-pr. 9 oz., 12-pr. 4 oz., 9-pr. 2 1/2 oz., 6-pr. 3 oz. ± 1/328 directs that existing shell with Moorsom gauge fuze hole are to be fitted with G.S. adapters permanently screwed in. New shell to have the G.S. bush. See p. 103 for directions for fixing the adapters. The 64-pr. segment shell does not appear in the equipment for the 64-pr. gun. See §§ 723, 1086, for details.

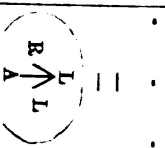



## 2. COMMON SHELL.

- Classes. Common shell are of two classes :—
1. Garrison or Naval.
  2. Field.
1. Garrison of naval. 1. *Garrison or Naval*.—7-inch, 64-pr., and 40-pr. Gauge, G.S. Fuzes, 9 seconds and 20 seconds B.L. and Pettman G.S. and R.L. screw percussion, Mark II.
- They are cylindrical in shape, the chamber is lacquered as usual to protect the bursting charge. Many of the earlier patterns have black lacquer. (*See p. 116.*)
- Their length is generally about  $2\frac{1}{2}$  calibres.
- For bursting charge, dimensions, &c., *see table, p. 116.*
- §§ 1038, 1119. It will be seen in the table that a light 7-inch shell has been introduced for S.S., the recoil of the heavy shell having proved inconveniently great on board ship. This shell may be met with in the L.S.; it is not suitable for use with the 7-inch gun of 72 cwt., charge 10 lbs., as the charge is not sufficient to ensure the lubricators breaking up properly when the light shell is used, the lubricant being blown out in lumps, instead of being evenly distributed along the bore; on an emergency, however, the shell might be used.
- Revised equipment, 1873, p. 7. The form of head adopted since 13/1/65 is ogival, struck with a radius of 1.5 diameters; prior to the above date various radii were used, and some of the shell are finished off with an abruptly curved nozzle.
2. Field. 2. *Field*.—20, 12, and 9-prs., gauge, Armstrong field service. Fuze, B.L. plain percussion (Navy, E. time in addition, except the 20-pr. S.S., which takes the 9 or 20 seconds and the R.L. screw percussion). They have a flanged gun-metal socket to take the fuze (Marks I. and II., 9 and 12-prs., are unserviceable, the first having no socket and the socket in II. having been proved to be too weak), the socket contracts at the bottom to prevent the fuze being put in with the rim down. *See plate, p. 331.*
- § 2061.
- § 1708. These shell have the B.L. field service plug; a papier mâché wad fits into the hole of the flanged socket to prevent the powder working up. This wad does not want to be taken out, as the fuze will blow it in on acting; the wads are pressed in by a wooden drift, the recessed side of the wad goes uppermost.



§§ 1345, 1426.

\* A 20-pr. shell with G.S. gauge has been introduced for S.S. Many 20-pr. shells have been converted from the Moorsom to the F.S. gauge by a flanged socket.

For bursting charge, dimensions, &c., *see* table, p. 116.

Common shell would generally be used against materiel, fuzed with Use. percussion fuses, but time-fuzes may be used if desired. It is well to remember that the fuzes with powder channels will generally act on impact, but the 20 seconds fuze is not to be depended on for this action.

Empty, loose, garrison service. Filled and fuzed with Pettman G.S. Issue. fuze, and issued loose for S.S.

*Field Service.*—Filled and boxed, or empty, loose, for transit.\*

---

\* For transit to India, the F.S. shell would be issued, empty, boxed.

COMMON SHELLS, B.L. GUNS.

Calibre and Mark of Pattern.	Date of Approval.	Changes in War Stores.	Length.	Weight, empty.	Approximate bursting charge, shell powder, L.G.	Gauge of Fuse Hole.	Attachment of Lead Coat.	Marks.			REMARKS.	
								Head.	Coat.	Base.		
7" (no Mark)	21/2/61	211	inches: 18-73	lbs. ozs. 95 14	lbs. ozs. 7 10	Moorson*	Tin	E. OC. F.				
"	30/12/61	405	18-75	± 2 lbs. 97 15	7 10	"	Undercut	E. OC. F.				Projecting bottom with flat centre plug; nozzle round fuze hole; black lacquer.
"	10/5/62	541	18-53	± 2 lbs. 98 2	7 10	"	Zinc		Z, date			Solid round bottom, nozzle; black lacquer.
"	26/3/63	753	18-53	± 2 lbs. 98 0	7 10	"	"					
Mark I.	15/9/65	1119	15-8	83 0	6 8	"	"					Flat solid bottom; black lacquer. For S.S.
"	11/5/67	1421	15-8	± 1½ lbs. 83 0	6 8	General service	"					Flat solid bottom; red lacquer. For S.S.
64-pr. (so called 70-pr. no Mark.)	6/12/62	664	14-7	64 0	4 12	Moorson	"	E. OC. C. Z.				Projecting bottom with flat centre plug; black lacquer. This shell is now issued from Woolwich for practice only.
64-pr. Mark I.	3/12/64	1042	13-88	59 8	4 8	"	"					Solid bottom, slightly rounded; black lacquer.
"	26/4/67	1423	13-88	± 1½ lbs. 59 8	4 8	General service	"					Solid bottom, slightly rounded; black lacquer.
40-pr. (no Mark)	22/1/61	209	13-87	37 10	2 4	Moorson	Tin	E. OC. C.				Projecting bottom with flat centre plug; nozzle; black lacquer.
"	30/12/61	405	13-87	± 1 lb. 38 7½	2 4	"	Undercut	E. OC. & C.				Projecting bottom with flat centre plug; nozzle; black lacquer.
Mark I.	10/5/62	541	13-52	± 1 lb. 37 14	2 4	"	Zinc		Z, date, I.			Flat solid bottom with flat centre plug; nozzle; black lacquer.
"	11/5/67	1425	13-52	37 14	2 4	General service	"					Flat solid bottom with flat centre plug; nozzle; red lacquer.
20-pr. (no Mark)	4/1/62	477	11-28	20 5	1 2	Moorson	Undercut	E. OC.				Projecting bottom with flat centre plug; nozzle; black lacquer.
Mark I.	4/1/62	477	10-91	± 9 ozs. 20 9	1 2	"	Zinc		Z, date,			Flat solid bottom, nozzle; black lacquer.
"	26/10/66	1342	10-875	± 9 ozs. 20 8	1 2	Field service	"					Flat solid bottom, flanged socket; red lacquer.
"	26/4/67	1426	10-5	± 4 ozs. 20 8	1 2	General service	"					Flat solid bottom, nozzle; red lacquer. For S.S.
12-pr. Mark III.	29/3/71	2061	8-35	± 4 ozs. 10 12	0 8	Field service	"					Flanged socket; red lacquer.
9-pr. Mark III.	29/3/71	2061	6-30	± 2½ ozs. 8 24	0 6	"	"					

N.B.—For 26-pr. now obsolete, see §1815. Marks I. and II. 12-pr. (§§1087 and 1345), Mark I. 9-pr. (not published) and Mark II. 9-pr. (1344) may be regarded as unserviceable; Mark I. had no socket, and the socket in Mark II. was too weak. See p. 103, for directions for fixing. For diameters at base, see table of segment shell, p. 113, that

## 3. SHRAPNEL SHELL.

1. Garrison or Naval.

Classes.

2. Field or Boat.

1. *Garrison or Naval*.\*—64-pr. and 40-pr. Gauge, G.S. Fuzes. 9 seconds, B.L. and R.L. screw percussion, Mark II. 1. Garrison or naval.

† Each shell consists of a hollow body with a head lightly attached to it. The body is of cast iron; it has a lead and antimony coat to take the grooving, in the case of the 40-pr. resembling exactly that of the segment shell Mark I., and in the case of the 64-pr. differing only in having the thick part of the coat, which gives the larger diameter, moved 2·5" forward from the base in order to cause the shell, in ramming home, to lodge 2·5" short of its intended seat, and so to bring it closer to the charge of powder which does not fill up the entire powder chamber; this arrangement makes the shell start more suddenly, and causes its fuze to ignite with greater certainty. Externally the 12 and 9 pr. shrapnel bodies nearly correspond with their respective segment and common shells.

The body is weakened internally by six longitudinal grooves running down the entire length of the interior, and forming lines of least resistance. The base is formed into a chamber to contain the bursting charge, the interior of the body is slightly conical, that is, it enlarges slightly towards the front, giving an increase of ·1" in diameter in larger, and ·05" in smaller calibres at the mouth; running round the mouth is a shoulder and groove forming a kind of recessed lip. A tin cup is placed in the chamber to contain the powder.

Over the mouth of the powder chamber rests a disc of wrought iron supported by a shoulder,‡ the disc is pierced in the centre and partly tapped to take a wrought-iron tube which is screwed into it, this tube itself being tapped at the top to take a gun-metal primer (*see* page 99) employed to assist in carrying the flash of the fuze to the bursting charge in the chamber.

On the diaphragm are placed bullets of lead and antimony, which are fixed by rosin being run in among them, brown paper being laid round the inside of the shell to prevent too firm adhesion of the rosin. Over the bullets and rosin is placed a kamptulicon disc.

The head is made of elm covered with a light shell, formerly of wrought iron, latterly, since 8/66, of Bessemer metal, the wood being bored out to contain a tin socket fitting round the iron tube of the body and holding in its mouth a gun-metal bush of G.S. gauge tapped to take the G.S. screw plug; this bush forms a small projecting socket above the apex of the shell.

---

\* 7-inch shrapnel has been made, but is not now included in equipment. (*See* Corps Equipment, p. 7, issued with A.C., January, 1873.)

§ 1609.

† In future manufacture of these shells probably they would be made similar to the later patterns of R.M.L. shrapnel of large calibres. *See* p. 154.

‡ The cast-iron disc used in early patterns was found to break up, and was liable to cause prematures.

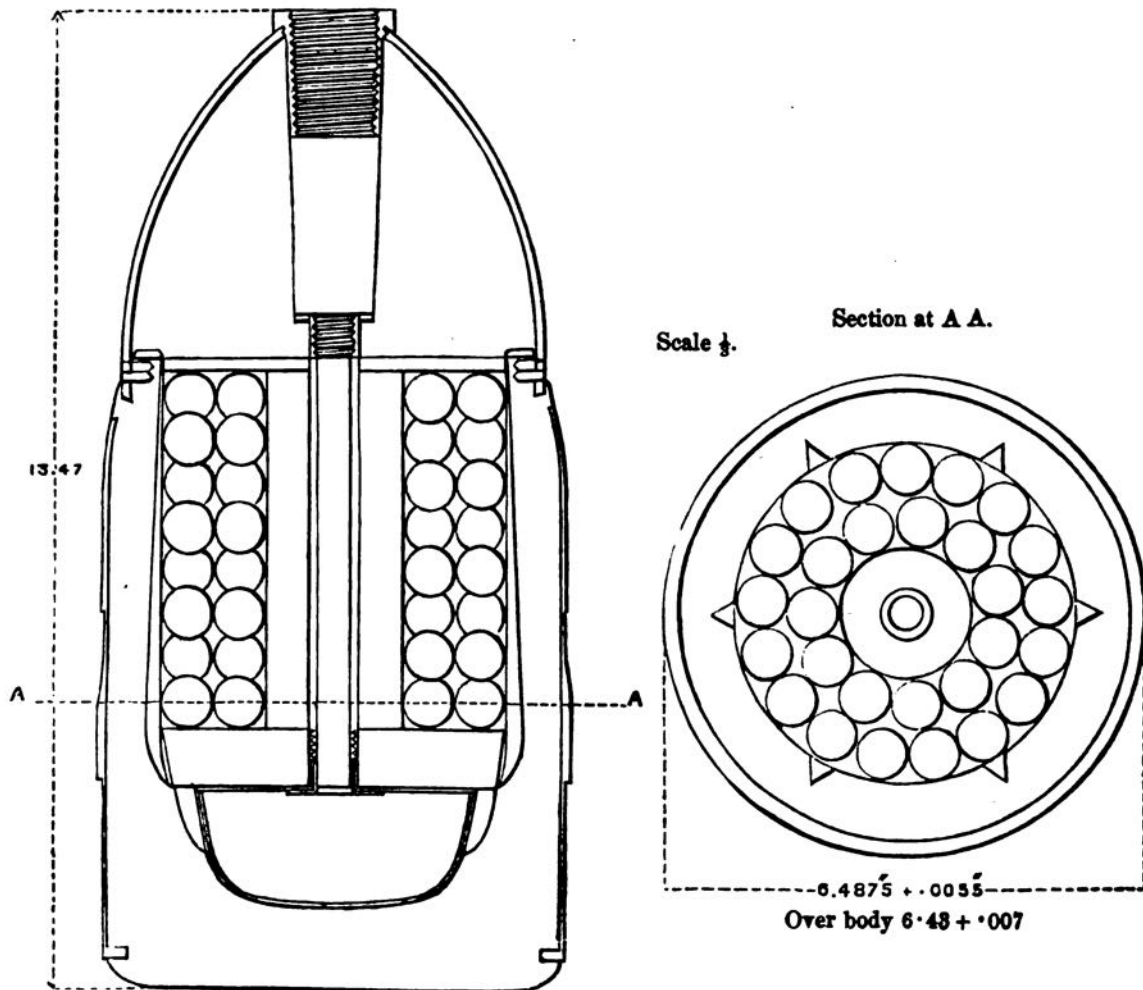

Boxer Shrapnel 64-PR. B.L. II.

It will be seen that the chief functions of the head are to cut through the air in flight and contain the fuze; being very light it brings the centre of gravity of the shell, which would otherwise come too far forward, to its proper position, and its inertia being reduced, it is possible to hold it to the shell by a light method of attachment, viz.; by means of steel rivets (12 in larger and 4 in smaller shells) and four steel twisting pins, these latter being rivets, sometimes fitted into slots instead of holes in the shell, so as to tend to prevent the head by its own inertia twisting away from the body, although in no way interfering with its liberation when blown to the front by the bursting charge.

The Bessemer metal head fits into a groove in the top of the body in the 64-pr., in the lower natures of shells the head is flush with the exterior of the body.

The 64-pr. has its tube surrounded by a hollow elm wood cylinder to enable its proportions to be good consistently with the calibre and weight required. All have weighed bursting charges of "service pistol powder," or "F.G.," as may be most convenient.\*

§ 2286.

\* R.F.G. may be substituted.



For bursting charge, dimensions, &c., see table, p. 122; and for instructions for filling, see p. 52.

1. Empty, loose, for L.S. with screw plugs.
2. Filled for S.S. with primers inserted and screw plugs, issued boxed.

2. *Field.*—12-pr. and 9-pr. Gauge G.S. Fuze 5 seconds B.L., and for long ranges, the 9 seconds B.L., also R.L. Screw percussion, Mark II.

The above description of garrison Shrapnel applies to the early patterns of F.S. shell. Experience showed that the attachment of the head in the smaller natures was too weak, the jolting motion of the limbers was found to loosen the heads, in some cases they came off, and frequently the rivets were loosened, occasionally the rim of cast iron to which the Bessemer metal head is attached broke off, the rosin was found to work up between the iron pipe and the tin socket, thus getting above the primer, and causing a liability to blind shell. Some of the primers

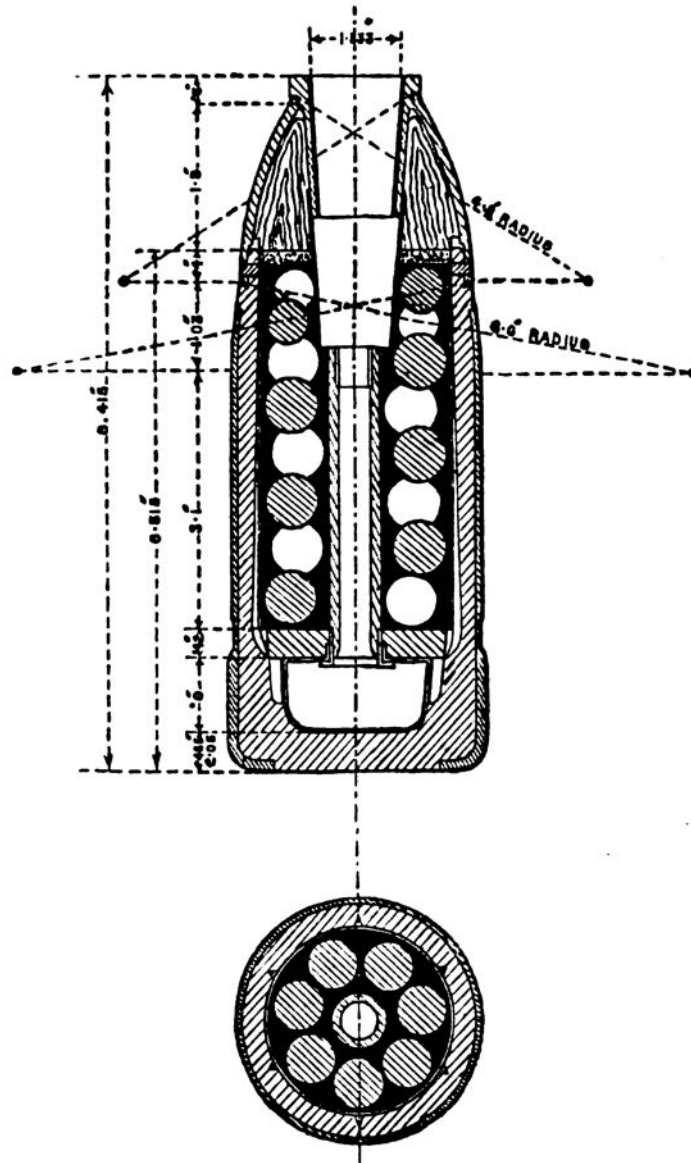

12-PR. SHRAPNEL, MARK I.

were found to be so tightly fastened by rust to the iron pipe, that it was impossible to unscrew them when the shells had to be emptied.

§ 2210.

In order to remedy these defects, the rim of cast iron was thickened while the Bessemer metal was turned down to a corresponding amount at the junction; the latter metal being so tough as to have a large margin of strength. The head is attached to the body by screws as well as rivets. A gun-metal tube with an enlarged head is substituted for the iron one, thus preventing the primer becoming fixed by corrosion, and to the head of the tube a tin socket is soldered, so as to prevent the rosin from working up. The felt or kamptulicon washer is soaked in kit composition, so as to keep the rosin better in its place.\*

For bursting charge, dimensions, &c., see p. 122.

For instructions for filling, &c., see p. 52.

Issue.

Filled and boxed, primers and plug screwed in. Sometimes issued empty, loose, and filled by the battery.†

Use of  
Shrapnel.

The effect of shrapnel like that of segment greatly depends on the correct estimate of the results that are being produced, and in most cases on the judgment displayed in the constant efforts to improve on the shooting: when used intelligently, the effect is most excellent.

It is possible generally from the gun to estimate the line and the height of the burst of the shell, but not the distance at which it occurs, and bad practice commonly arises from a too sanguine estimate of effects judging from the appearance of the smoke of the burst alone; particular attention should therefore be paid to any visible marks of the bullets grazing. On water, splashes will be seen, on dry ground, puffs of dust, on ice, very distinctly scored marks, on wet or boggy ground nothing is commonly visible.

Shrapnel should be burst closer to compact masses of troops than to more open formations.

F.S. Shrapnel should be burst well within 100 yards of the object; as a rule, about 50 yards off, and about from 10 to 15 feet above the plane; these distances will, however, vary with the object aimed at; these shell should be burst nearer to a column than to a line. In the Report of the Committee on Indian Field Equipment, page 53, it is stated that at 1,000 yards the dimensions of the cone of dispersion are as follows:  $A.B = \frac{1}{3} C.D.$ , the centre of the cone D. falls  $\frac{1}{2}$  of C.D.

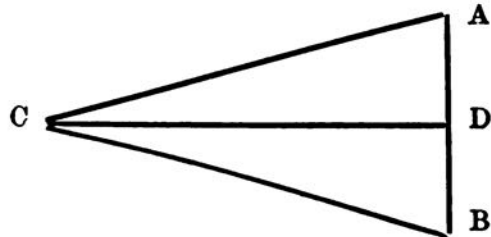

Suppose the object aimed at to show a front of 60 feet, then  $A.B = 60$  feet,  $C.D.$ , 180 feet, or 60 yards, the fall will be  $\frac{1}{3}$  of 60 feet = 15 feet, therefore, in the supposed case firing at a front of 60 feet, the range being 1,000 yards, we ought to burst the shell 60 yards off and 15 feet above the plane.

In order to get the best results from F.S. Shrapnel, it is necessary to have a time-fuze reading to very short intervals of time. We may say

§ 2210.

\* A few shells have been issued prior to the change of numeral which have the gun metal tube, &c. and some with the strengthened attachment of the head; they are marked on the lead coat with one star (\*), or two stars (\*\*) when all the improvements are introduced.

† For transit to India, the shell would be issued, empty, boxed.

that the shell from a 12-pr. B.L. gun travels at the rate of 300 yards in a second, this would give 150 yards to half a second, and 75 yards to a quarter second, thus, even the five seconds fuze would hardly read close enough, and this fuze is available only up to about 1,600 yards from a B.L. gun; above this range the nine seconds fuze must be used which reads to half seconds, corresponding to intervals of about 150 yards in range, with this fuze much of the effect of Shrapnel must be lost.

The necessity for a finely divided fuze is even greater for M.L. guns which have a higher velocity. As before pointed out, this object might probably be attained by making four powder channels in the fuzes, so causing the five seconds fuze to read  $\frac{1}{2}$  seconds, and the nine seconds fuze,  $\frac{1}{4}$  seconds.\*

Until the last few years Shrapnel were employed exclusively with time fuzes, but recent experiments have shown that where local effects are desired (when firing against dense masses of men, or perhaps against artillery), percussion fuzes may be employed with advantage. Very good results have been obtained in firing Shrapnel with the R.L. percussion fuze from the 16-pr. R.M.L. (see p. 208), and from the 9-pr. R.M.L., but percussion fuzes for Shrapnel shell are not included in the B.L. equipment, the R.L. percussion fuze would no doubt answer. At long ranges the percussion fuze does not answer well, as the shell descending at a sharp angle has a tendency to bury itself in the ground.

It is impossible to lay down the exact effective range of Shrapnel from field guns, probably with B.L. field guns they would be effective up to about 1,800 or 1,900 yards.†

---

\* Six nine seconds fuzes, having four powder channels, were fired at Shoeburyness, they acted well.

† Two thousand metres is given as the limit in "Recherches sur les Fusées par Romberg."

The report of the Special Committee on Shrapnel v. Segment Shells gives the result of a large amount of practice; the practice was generally carried on at ranges well under 2,000 yards. On page 31 the result is given of firing shrapnel at a range of 2,000 yards, the effect was very slight.

## SHRAPNEL SHELL B.L. GUNS.

Calibre, and Mark of Pattern.	Date of Approval.	§ Changes in War Stores.	Length, inches.	Number and Nature of Balls contained.	Weight of Shell empty, lbs. oz. ± 1.5 per cent.	Weighted bursting charge, Pistol, or F.G. powder.	Total weight of filled shell, lbs. oz.	Gauge of fuze hole.	REMARKS.
64-pr. Mark II* -	21/3/68	1,609	13.47	224, lead and antimony, 14 per lb.	lbs. oz. 65 14	lb. oz. 0 5	lbs. oz. 66 8	General Service	
40-pr. " I -	7/7/69	1,807	12.4	" " 16 per lb.	39 0	0 3	39 3	" "	
12-pr. " I† -	20/10/70	1,978	8.415	" " { 42, 18 per lb. } 14, 34 "	10 11	0 0½	10 11½	" "	
" " II‡ -	15/2/72	2,210	"	" " "	" "	" "	" "	" "	Junction of head and body stronger, and secured by screw as well as by plain rivets, centre tube of gun metal instead of iron.
9-pr. " I† -	20/10/70	1,979	7.15	42, " { 21, 18 per lb. } 21, 34 "	8 11	" "	8 11½	" "	
" " II‡ -	15/2/72	2,210	"	" " "	" "	" "	" "	" "	Same remarks as to 12-pr. II.

\* Mark I, 7" and 64-pr. (§§ 1422, 1391) with cast iron diaphragms and without tin cups are ordered to be broken up. There is a Mark II, 7" Shrapnel (§1609) but it forms no part of the equipment for that gun.

† Shells with stronger sockets sealed to govern future manufacture, without a change of pattern, marked "P.S." (plain socket), on the lead coat, § 2062.

‡ A few shells have been made and issued which have the junction of head and body stronger (*Vide* remarks), and some with all the improvements, viz.—strengthened head and gun metal tube, the former are distinguished by one small star (\*) and the latter, those with all the improvements, by two small stars on the lead coat, § 2210.

Diameters at base, same as Segment and Common Shell.

All Shrapnel have the zinc attachment.

The various natures of shell for F.S. are readily distinguished, one from another, by the following marks :—The Shrapnel have their heads painted red and the gun-metal socket projects; the common shells have the gun-metal of their flanged sockets showing as a ring round their fuze hole; while the segment has simply a fuze hole tapped in the metal of the shell. Distinctive features of B.L. shell.

The garrison service shells are more difficult to distinguish; the Shrapnel shells are known by their projecting socket, but it is sometimes hard to distinguish between common and segment shells; as a general rule the common are longer and have a more gradually curved head than the segment; however, the specially light 7" common shell is little longer than the segment, but by looking at the base of the shell it can be seen that the lead coating extends farther in the segment than in the common shell, as the base is secured by the lead coating. By unscrewing the plug, and feeling for the grooves in the head with a bent wire, the segment may be recognized.

The lead coating at the bottom of field service shells is rounded off to prevent their getting enlarged at the base by jolting in the limbers.

#### GAUGES, IRON, RING, SHELL OR SHOT, B.L. GUNS.

\* High and low gauges are issued to stations of inspection, the former passing over the projectile, the latter resting at the back end behind the cannelure. § 1313.

The high gauge passing over secures the shell loading, should the lead be a little set up, it can easily be filed down to the correct dimensions. This gauge is issued to Field Artillery.

The dimensions of the gauges are as follows :—

	High, Diameter.	Low, Diameter.
	Inches.	Inches.
7 inch -	7·095	7·08
64-pr. -	6·595	6·482
40-pr. -	4·855	4·83
20-pr. -	3·85	3·836
12 and 9-pr. -	3·10	3·067
6-pr. -	2·60	2·567

#### SHOT.

Are of the following classes:

1. Case Shot.
2. Solid "
3. Drill "

*Case Shot.*—Though apparently a simple projectile, it is difficult to obtain a really good case shot for rifled guns. It is necessary to preserve the bore from the iron sand shot used in the larger natures of case; 1. Case shot.

\* The high gauge was formerly called a "test ring." § 1017.

In manufacture five gauges are used, viz. :—

- 1 for commencement of taper near point.
- 1 high and 1 low for body.
- 1 " and 1 " for back end.

In gauging a B.L. projectile standing on a table, the high back end should descend over the entire projectile and lie on the table; the low back end gauge should stop at the commencement of the back end behind the cannelure (in 64-pr. Boxer shrapnel the front cannelure of the two); the high body gauge should descend and rest on the last-mentioned one. Gauging a B.L. projectile.

The proper position for the low body and commencement of taper gauges to rest is not so well defined, but the former should not pass over what is obviously the full diameter of the body, and the latter should stop at a point a little above it.



it is also necessary to make the case sufficiently rigid not to set up and expand, because if it does, the shot takes the rifling and scatters to such an extent as to be useless. It is necessary to make F.S. case sufficiently strong to stand knocking about in the limbers and yet weak enough to open when fired with a small charge. Experiments were carried on with case shot enclosed in discs of wood, proposed by Lieut. Reeves, R.A., but the manufacture of this class of case shot has for a long time been discontinued, though the 6-pr. still retains Reeves' Case as a service projectile.

§ 1241.

§ 1611.

The R.L. pattern of case is now adopted.

The general construction of B.L. and R.M.L. case is similar, but the former have solder studs to prevent their being rammed too far into the bore.\*

As before stated, page 95, the weight of case shot is less than that of other projectiles fired from the same gun, the rule laid down is, that case shot should weigh  $\frac{3}{4}$  the weight of the other projectiles for guns up to 7-inch inclusive, above that calibre case shot is to be regulated by the weight of the round shot of the calibre. This rule was laid down in 1864,† but is not strictly adhered to. For B.L. guns having a small charge of powder compared to the old S.B. guns, it is evidently desirable to keep down the weight of the case‡ shot. The rule is less important for R.M.L. guns, but even their charges are less than those of S.B. guns of corresponding calibre.

The balls of the earlier patterns of case shot are packed in coal dust, but equal parts of clay and sand are now used, the case thus made are found to give better results than those in which the coal dust was used.

Garrison  
case shot.  
§ 2602.

*Garrison case shot*, 7" 64-pr., and 40-pr., the case is sheet iron with fringed ends. The iron of those made since 3/3/74 is tinned to preserve the case from rust. An iron bottom is riveted to the lower fringe, on which rests a wrought-iron disc; on this stands a lining of three wrought-iron curved plates or segments; within are sand shot (8 oz.), packed in sand and clay and covered with an iron top fringed and soldered down. The 7" and 64-pr. have an iron handle.

The 7" case shot, both Reeves' and Laboratory pattern is made to suit both M.L. and B.L. 7" guns by having three large solder studs at one end, which cause it to stop in the shot chamber when ramming home in a B.L. gun, but find room in the three deep grooves of the Woolwich gun. This plan is not applicable to the 64-pr., for the calibre of the B.L. 64-pr. wedge gun is 6.4", while that of the M.L. shunt gun is only 6.3 inch. Mark II., 40-pr., has its case made of tin in 3 pieces.

For dimensions, &c. see tables (p. 127.)

Issue.  
Field  
case shot.

Loose, except the 40-pr. tin case, which is boxed.

*Field service case shot*.—20-pr. § 12-pr. 9-pr. and 6-pr.

For the field service guns the pattern is generally similar, except that the case is made of tin, with tin ends, the bottom strengthened with an iron ring riveted on, the top has a wood lining, the iron disc and linings of iron segments as before. In the latest patterns the tin cylinder is made of three pieces soldered together, in order to cause it to open more readily. The balls are lead and antimony packed in sand and clay.

The pattern of the 6-pr. has not yet been altered.

§ 2058.

\* Some B.L. F.S. shot have rings instead of studs, but these were abandoned.

† See Extracts, Vol. IV., p. 397.

‡ The 42-pr. S.B. had a charge of 10½ lbs. while the 40-pr. B.L. has only a 5 lb. charge, if the B.L. case weighed 40 lbs. its effect would be slight.

§ A 20-pr. case shot containing 162 lead and antimony balls, total weight 20 lbs. 1½ oz., has been approved for future manufacture; its construction is similar to the 12 and 9-pr. case shot.

## 12-pr. Case Shot, Mark IV.

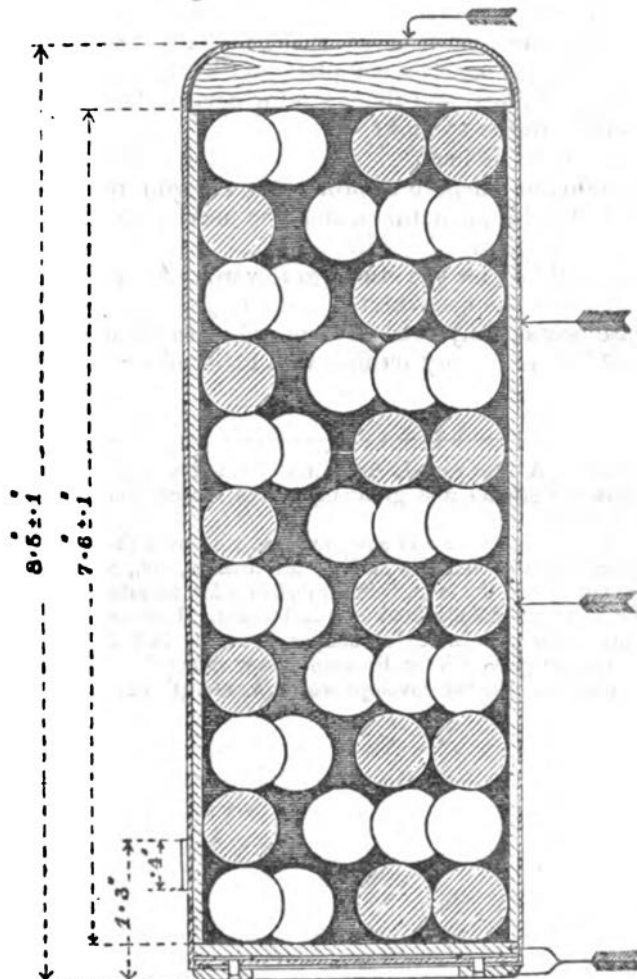

The lead and antimony balls, being much heavier than iron balls of a corresponding size, keep up their velocity better. Sand shot are used for economy in the garrison case shot.

Packed in boxes for transit.

The general use of case is when firing at troops at about 300 yards; when the ground is hard and level it is not necessary to give elevation from heavy guns at short ranges, as the bullets run along the ground, on soft or uneven ground the effect of case is much diminished, as the destructive effects depends mainly on ricochet; over such ground elevation should be given according to distance.\* Generally about 1° of elevation may be given from field guns at 300 yards.

Issue.  
Use of case  
shot.

\* Captain C. O. Browne states as follows:—

The effect of the case and grape fired on the English advancing on the Redan on September 8th, 1855, in the siege of Sebastopol, was such as will not readily be forgotten by those who saw it; the ground was fairly level, hard, and very dry. I happened to be in a battery well placed for view, and being ordered to discontinue my fire as the troops advanced I had full opportunity of watching the effects; each gun flash from the flanks of the work was followed by puffs of dust commencing perhaps 50 yards from the muzzle, and running along the ground in an accumulating shower which died away at some hundred yards distance, some stray grape of large size even ringing on the stony ground and entering batteries 1,000 yards from the

It will be seen by looking at the table (p. 127) that much of the weight of the shot is taken up by the exterior case, segmental iron lining, discs, &c., in some instances as much as half the total weight of the projectile ;\* this is nearly a complete loss to the efficiency of the shot, as the segmental linings, and the exterior part of the case generally, are of a shape unfavourable to flight.

It is, however, difficult to get rid of the segmental linings, which answer the double purpose of protecting the gun from the action of the iron balls in the larger natures, and also make the case sufficiently rigid to prevent their taking the rifling.

Loading.

In loading B.L. case the studs go towards the rear, thus bringing the strongest part of the case next to the charge.

F.S. case occasionally become damaged in the limbers, they can readily be repaired by the battery artificers ; a little solder is generally all that is wanting.

Russian works. A few rounds fired nearly simultaneously sufficed to sweep and regularly dust the ground, and gradually as the attack continued it became dotted with bodies of men.

The effects of the grape and case on June 18th over the same ground were very much greater, both the Generals leading the attacks, viz., Sir J. Campbell and Yea, and a large number of the men, being killed in a few minutes ; the column led by the former officer suffered chiefly from case and grape. I missed seeing this attack, but conclude the effect was increased simply from the fact that there were a larger number of Russian guns neither dismounted nor silenced.

\* In the old S.B. case the envelope weighed only  $\frac{1}{3}$ th the weight of the projectile.

CASE SHOT, B.L. GUNS.

Calibre and Mark of Pattern.	Date of Approval.	Changes in War Stores.	Length, inches.	Diameters, inches.		Number and Nature of balls contained.	Approximate weight of balls.		Approximate weight of case, linings, coal dust or clay and sand.	Total weight.	Marks on the top of the Case.	Number of Solder Studs at Base.	REMARKS.
				Over body.	Over studs.								
7 inch, Mark III.	24/3/68	1611 & 2444	10.25 ± .1	6.89 ± .03	7.097 - .08	74 8 oz. sand shot	lbs. oz. 36 5	lbs. oz. 30 11	67 0 ± 2 lbs.	III. W. ↗ D. 7 in. M.L. or B.L.	3	Balls packed in coal dust, surplus stores to be returned to Woolwich for alteration to IV. Balls packed in clay and sand. Balls packed in coal dust. Balls packed in clay and sand. Balls packed in coal dust. Balls packed in coal dust.	
" IV.	25/1/72	2188	"	"	7.006	70 "	35 0	34 0	69 0 ± 24 lbs.	IV. "	"	"	
64-pr. "	24/3/68	1611	9.0 ± .1	6.3 ± .03	6.487 - .005	56 "	27 5½	20 10½	48 0 ± 14 lbs.	I. " 64-pr. B.L.	6	"	
" II.	30/4/72	Not yet sealed.	"	"	"	49 "	24 8	25 8	50 0	II. "	"	"	
40-pr. "	24/3/68	1611	10.15 ± .1	4.715 ± .015	4.885 ± .015	37 "	18 8	11 8	30 0 ± 1 lb.	I. " 40-pr. B.L.	24	"	
" II.	30/4/72	2364	"	"	"	35 "	17 8	14 0	31 8 ± 1 lb.	II. "	3	"	
20-pr. "	25/9/68	1299	8.4 ± .05	3.705 ± .015	"	55 lead and antimony, 4 oz.	13 12	1 2	14 14	I. " 20-pr. B.L.	Studs.	"	
" II.	22/3/68	1611	9.3 ± .1	"	3.841 ± .015	41 4 oz. sand shot	9 12½	5 3½	15 0 ± 12 oz.	II. "	Divided ring.	"	
" III.	"	Not yet sealed.	"	"	"	232 lead and antimony bullets, 16½ per lb.	14 0	0 1½	20 1½ ± 8 oz.	III. "	3 studs.	"	
12 or 9-pr. "	9/3/68	1942 1900	10.5	2.97	3.074	77 lead and antimony, 7 per lb.	11 0	1 8½	12 8½	I. " 12 or 9-pr. B.L.	12 "	Reeves' pattern withdrawn from L.S. issued to S.S. only.	
12-pr. "	9/8/67	1467 1900	6½	"	"	70 lead and antimony, 1½ oz. each.	6 9	2 7	9 0	II. "	12 "	"	
" III.	24/3/68	1611 2058	8.5 ± .1	2.96 ± .015	3.12 ± .015	48, 2 oz. sand shot	6 0	3 0	9 0 ± 8 oz.	III. " (marked wrongly).	Divided ring.	"	
" IV.	15/2/71	2068	"	2.96 ± .01	3.117 ± .002	132 lead and antimony bullets, 16½ per lb.	8 1½	3 6½	11 8 ± 6 oz.	IV. "	3 studs.	"	
9-pr. "	29/1/70	1867 2058	6.85 ± .1	2.95 ± .01	3.07 - .003	35, 2 oz. sand shot	4 0	2 3½	6 9½	II. " 9-pr. B.L.	Divided ring.	"	
" III.	15.2.71	2059	"	2.87 ± .06	3.117 ± .002	101 lead and antimony bullets, 16½ per lb.	6 3	2 13	9 0 ± 6 oz.	III. "	3 studs.	"	
6-pr. "	25/9/68 Provly.	1299	5.8 ± .05	2.465 ± .015	"	61 lead and antimony bullets, 16 per lb. and one do. of ½ oz.	3 13½	0 6½	4 4 ± 2½	II. " 6-pr. B.L.	12	Reeves' pattern, balls packed in sawdust, wood lining.	

7" Marks I. and II. §§ 1241 and 1611 are by § 2444 ordered to be returned to Woolwich to be broken up. A few 6-pr. Mark I. were issued to Jamaica on urgent demand in 12/65 as Mark I., but no circular was promulgated, and no sealed pattern exists.

- Solid shot. *Solid Shot.*—Calibres 40-pr.,\* 20-pr., 12-pr., 9-pr., and 6-pr. They are only used for practice. They have much the same form and length as segment shells. They approximate closely to the nominal weight: various patterns exist having tin, undercut, or zinc attachment.
- Issue. They are issued loose, but might be packed in boxes if convenient for transit or for India.†
- Drill shot. *Drill Shot.*—For the larger guns, down to the 20-pr. inclusive, recovered shells, with their coating turned down, are used. For the 9 and 12 prs., special shot are used with the lead coating extending over the head, to avoid injury to the copper bush. The 6-pr. has a special drill shot.
- §§ 1742, 942, 1088. The shell used for drill shot may be known by the absence of cannelures.

#### CARTRIDGES, AND MISCELLANEOUS STORES CONNECTED WITH THEM.

- The weight of the charge is  $\frac{1}{3}$  of the weight of the projectile, except for the 7" and 64-pr. guns. The 7" of 82 cwt. has a charge of 11 lbs.; the 7" of 72 cwt. has a charge of 10 lbs.‡ In the L.S. the 98-lb. shell is used with both guns.
- § 1828. The 64-pr. has a charge of 9 lbs., a lighter charge having failed to ignite the detonator of the B.L. fuze.
- The powder employed is L.G., under the rule given on page 282, but R.L.G. will be resorted to when the stock of L.G. is used up.
- The cartridge is made of serge, the bottom is formed of a circular piece, and the cylindrical part from a rectangular piece; the seams are made to overlap and are sewn with three rows of stitches, except the seam forming the junction of the body and bottom in the 12-pr., and under, where two rows of stitches are used. The cartridges are hooped with blue braid; the empty cartridges are issued with braid inserted; one end of the braid has a loop through which the loose end is passed, and a single bend is formed with it on to the loop. Care is necessary, as men are apt to make the knot off the loop or a wrong knot, which slips and the hooping is rendered useless.
- Lubricators. § A lubricator, consisting of two thin cups of tinned iron soldered together, containing a mixture of equal parts of tallow and linseed oil, attached to a wad of felt, backed by millboard (the edges of the wad being coated with beeswax), is inserted into the cartridge. It is put on the top of the powder, just above the top hoop in all cases, except the 40-pr. S.S. and 7", which have their lubricators detached to save room in the magazine.
- § 1486. The lubricator proper is fastened to the wads by the stalk in the case of a detached lubricator, by a short stalk cut flush with the millboard

§§ 1038, 1815, 1347. \* The 7" and 64-pr. shot were withdrawn, as they were too heavy for the guns; hollow and hollow-headed shot may also be regarded as obsolete.

† The dimensions, &c. of the solid shot will be found in the Changes of War Stores 40-pr. § 209, 405; 20-pr. § 341, 405, 1298; 12-pr. § 162, 270, 405, 477; 9-pr. § 600; 6-pr. § 344, 405, 477.

§ 1038. ‡ These guns had at first heavier charges, but it was found necessary to reduce them to diminish the strain on the guns, hence the necessity for paper cylinders to enable the cartridge to be brought up to the required length to fill the chamber.

§ 1510. § The edge of the millboard wad of every inside lubricator is rounded off.



in the case of the 64-pr., and by a copper wire, in the case of every other inside lubricator, the wire being fastened to the closing disc.

The front surface of the felt wad is waxed when issued for India.

Lubricators are generally packed in "cases for Laboratory stores," as follows:—

7"	24 in No. 2 case.
64-pr.	20 in No. 5 "
40-pr. S.S.	48 in No. 3 "
40 pr. L.S.	66 in No. 3 "
20-pr.	99 in No. 4 "
12 or 9-pr.	168 in No. 4 "
6-pr.	224 in No. 4 "

With the 40-pr. S.S. and 7-inch, a wooden socket is choked into the neck of the cartridge, on to which the lubricator screws.\* The use of the lubricator is to prevent the guns leading; the cups being broken by the discharge the lubricant is squeezed out, and the wad following wipes and polishes the bore. All B.L. service cartridges are choked with twine; the 7" L.S. and S.S., and the 40-pr. S.S. have a running string in the mouth for choking in the socket for the lubricator. The chokes of all, except the 7" are cut to a length of one inch; the 7" choke is cut to 1½".

Sockets, wood,  
B.L. cartridges  
§§ 1939, 2170.

With the 7" 40† and 20-pr. a paper cylinder is used to bring the cartridge up to length, the cartridge is half filled with powder, the cylinder is next inserted, so as to be in the centre of the cartridge, and then the rest of the charge. One end is formed by choking up the

Paper  
cylinders,  
B.L. cartridges.  
§ 792.

*Cylinder for 7-inch, 10 lbs. charge.*

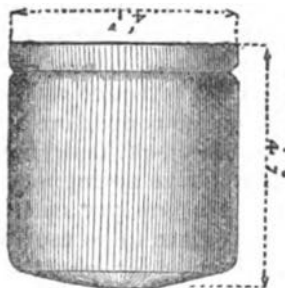

cylinder on a former and closing the hollow by a paper disc; the other end has a groove choked into it, so as to support a cardboard disc, which is glued in. The end formed of the cylinder itself is the strongest, and is placed downwards in the cartridge. These cylinders are issued separately in vats containing 220 for the 10 lbs. cartridge 7" gun, 390 for the 11 lb. cartridge 7" gun, or for the 40-pr., and 700 for the 20-pr. cartridge.

Issue.

\* A paper socket was used at first, but was abandoned as it was found to absorb moisture. The socket has a groove around its neck, smeared with kit composition and spanish brown, by means of which it is securely fixed in its place. §§ 406, 422.

† The same cylinder is used for the 40-pr. and the 11 lbs. charge of the 7", length 4.5", diameter 4.1". For 20-pr. the cylinder is 4.5" long, diameter 2.5". An early pattern existed which was found too weak, it was liable to be crushed in the cartridge, and portions of them were found to remain in the gun after discharge so as to impede loading for the next round. The weak pattern may be known by both ends being closed by paper discs. § 792.

§ 1939.  
Cl. 97 A.C.  
1870.

It was found necessary to varnish the paper, as otherwise it absorbed moisture and damaged the powder, for this reason also the paper socket for the lubricator was abandoned, as paper is very apt to absorb moisture\* when unvarnished; it is never desirable to have it in contact with powder.

§ 1998.

The cartridges are marked B.L. in addition to the nature of gun and weight of charge, thus the 12-pr. cartridge is marked "12-pr. B.L. 1 lb. 8 oz.," if filled with L.G. powder "L.G." is marked in red.

#### *Issue of Cartridges.*

Issue of  
cartridges.

For packing of filled cartridges, *see* table, p. 134, and also p. 93.†  
Empty cartridges are issued in bales in the following numbers or less:—

7-inch	{	11 lbs.	-	-	-	400
		10 lbs.	-	-	-	400
64-pr.,		9 lbs.	-	-	-	400
40-pr.,		5 lbs.	-	-	-	600
20-pr.,		2½ lbs.	-	-	-	800
12-pr.,		1½ lbs.	-	-	-	1,000
9-pr.,		1¼ lbs.	-	-	-	1,000
6-pr.,		12 ozs.	-	-	-	1,500

Those for detached lubricators have kitted choking twine run in round the mouth; all have the braids inserted.

The bales are cased in oiled calico and hessian.

Tin cups.

*Tin Cups* are used for all B.L. guns to prevent any escape of gas; they have a rim .32" deep, which is pressed back by the explosion of the powder against the sides of the bore, thus preventing the gas from getting behind them. The cups for wedge guns have a slight slit across the central hole to enable them to be fastened to the stopper, the central hole allows the flash from the tube or primer to reach the cartridge.

§ 1794, Cl. 197  
A.C. /71 and  
errata A.C.  
December /71.

The tin cups are only used for practice and exercise with field guns and the 40-pr., as they have got a copper bush which stands the escape of gas better than iron, but the 64-pr. and 7" guns require them also as a service store, as these guns have no copper bush.

For the 7" and 64-prs. one tin cup per cartridge is to be issued for service, and as many as required are to be used at practice.

Issue.

They are packed in packing cases for laboratory stores.  
See table, p. 131.

---

\* See Extracts, Vol. VIII., p. 30, where an account is given of the deterioration of B.L. cartridges having unvarnished cylinders in magazines where M.L. cartridges kept well. Army Circular, July, 1870 directs that the unvarnished cylinders be replaced by varnished ones, and the paper socket to be replaced by a wooden one.

#### *Instructions for varnishing Paper Cylinders used in Cannon Cartridges.*

The cylinder should be placed in a warm and dry room, or stove, or closet (temperature not to exceed 80°), until thoroughly dry, and then varnished with two coats of the under-mentioned composition, using an ordinary paint brush for the purpose, viz. :—

Shellac -	-	-	4 lbs.	{	To be placed in a can or bottle and frequently stirred and shaken until the shellac is dissolved.
Spirit, methylated	-	-	1 gall.		

After the first coat has become dry (which will be in about one hour) the second coat is to be applied, and allowed to remain until thoroughly dry.

The coatings should be thinly and evenly laid on, and worked into the folds as much as possible.

† The 12 or 9-pr. B.L. gun carries four filled service cartridges in the axletree boxes, packed in copper cylinders.

DETAILS OF PATTERNS OF TIN CUPS FOR B.L. GUNS.

Nature of Gun for which intended.	Date of Approval.	§ of Changes in War Stores.	Diameter.	Marks.	Remarks.
7"	11/1/62	489	ins. 7.253	7 IX. BL. 7.253. I. LO. RL. W $\nearrow$ D.	Low gauge cup to suit greater rigidity of the wrought-iron bush ring, also used for copper bushes at first.
All 7" except the above has become obsolete by § 1815, published 7/9/69.					
64-pr. wedge	19/11/64	1018	6.662 to 6.658	64 PR. BL. 6.66. L. RL. W $\nearrow$ D.	---
40-pr. wedge	{ Provsly. 15/1/63	735	5.001 to 4.997	Nil	Finally approved 27/1/66, see § 1209.
40-pr.	6/7/65	1163	4.96	L. 40-PR. 4.96. RL. W $\nearrow$ D.*	Approved for general issue for broadside guns, 21/2/66, vide § 1208.
20-pr.	6/7/65	1163	3.94	L. 20-PR. RL. W $\nearrow$ D.*	Approved for general service for broadside guns, 21/2/66, vide § 1208.
12 or 9-pr.	6/7/65	1163	3.197	L. 12 OR 9 PR. RL. W $\nearrow$ D.*	---
6-pr.	6/7/65	1163	2.622	6 PR. 2.622". RL. W $\nearrow$ D.*	---

\* These cups may be found with the letters M.G. (for medium gauge) stamped on them.  
 N.B.—§ 736 approves of 40, 20, and 6-pr. high and low gauge cups, both of tin and copper, for testing endurance, but these are not service articles and need not be particularly noticed.  
 § 1014 directs that tin cups are to be employed in firing guns for the proof of vent pieces, approved 8/2/64.

Primers,  
vent piece.  
§ 943.

Issue.

§ 913.

*Primers* are used for the 7" and 40-prs.; they consist of tubes of leather paper about 2½" long, driven with mealed powder and pierced like a tube, having strands of red worsted attached, which keep the primer in the hole in the vent piece. These are the only special primers made; they are painted black, and packed 25 in a tin cylinder. Field batteries, however, carry 15 blank muzzle-loading small-arm cartridges in a blue serge bag with each sub-division; they are only to be used if the friction tubes are found to fail to fire the charge. The powder is poured into the hole in the face of the vent piece, and the paper of the cartridge placed on top, to prevent its falling out; it is very seldom necessary to use them.\*

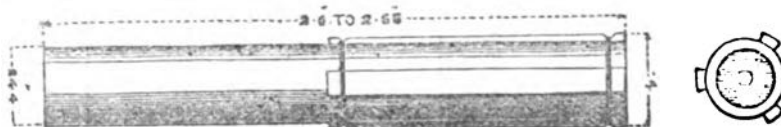

Saluting  
charges.

*Saluting, or Exercise Cartridges* are generally similar to the service cartridge, except that they contain less powder, have no lubricators or paper cylinders, and are choked with worsted, as twine is liable to carry fire, they have a becket of braid sewn on behind to facilitate unloading if necessary; the braid is sewn down for 1" at each side on the edge to prevent jamming with the vent piece. The 9 and 12-prs. have worsted instead of braid, which was found to obstruct the flash.

The charges are 7", 7 lbs.; 64-pr., 5 lbs.; 40-pr., 3 lbs.; 20-pr., 1½ lbs.; 12-pr. or 9-pr., 1 lb.; 6-pr., 10 oz. Exercise L.G. or R.L.G. being used.

§ 1293.

The 12-pr. or 9-pr. has a sawdust cartridge stitched on in front to lengthen it. The 6-pr. has the same arrangement.

The cartridges are marked with the nature of gun, weight of charge, and also with the word "Blank," thus, 7" B.L., 7 lbs., Blank.

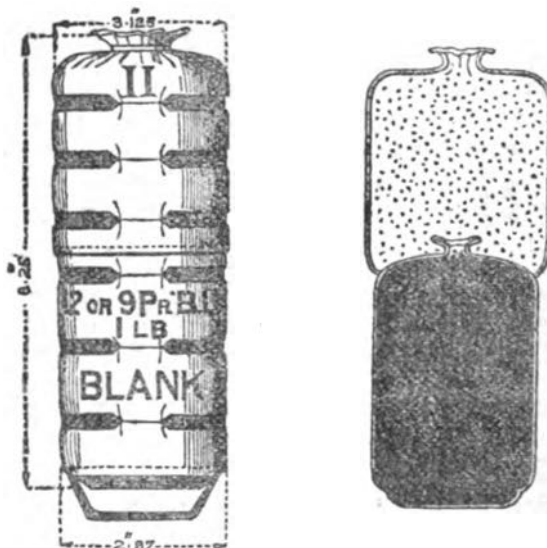

§ 165.

\* Primers for 12-pr. gun were withdrawn in 1860, a change in the vent piece rendering them unnecessary.

§§ 618,  
1815.

A primer made like that described in the text, but made of parchment and shorter, was introduced for the 7" and 40-prs. in 1862, but was ordered to be withdrawn in 1869.

*Packing and Issue.*

Blank cartridges are issued in the same manner as the service cartridges. Packing and issue.

The empty ones are made up in bales in the following numbers, or less :—

7", 7 lbs. -	-	-	500
64-pr., 5 lbs. -	-	-	600
40-pr., 3 lbs. -	-	-	800
20-pr., 1½ lbs. -	-	-	1,000
12 or 9-pr., 1 lb. -	-	-	800
6 pr., 10 ozs. -	-	-	1,000



TABLE OF FILLED CANNON CARTRIDGES.—B.L. RIFLED ORDNANCE.

Nature.	Description.	Date of Approval.	§ in Changes of War Stores.	Charge.	Length.	Diameter.	Paper Cylinder		No. and Nature of Braid Hoops.	Marks.	Number Packed and Weight of package in Pounds.																		
							Ins.	Ins.			Cases, Powder.						Metal or Brass.												
											Copper-lined.			Pentagon.			Rectangular.			Corrugated.									
											Whole	Half.	Quarter.	Whole	Sec- tional.	Plain.	A	B	C	D	Number.	Weight.	Number.	Weight.	Number.	Weight.	Number.	Weight.	
7-inch	{ Full, I. Blank, I.	{ 20/1/65 12/11/62	1088-9 632	11" L.G.	10 to 11	7.03	4.5	3.25	5	I. 7 IX. BL. 11 lbs.	8 141	3 65	7 142	6 70	9 174	9 152	—	—	—	—	—	—	—	—	—	—	—	—	—
6+pr.	{ Full, I. Blank, I.	{ 27/6/67 24/8/69	1415 1828	" "	6 " 6.5	" "	" "	" "	2	I. 7 in. BL. 7 lbs. Blank	8 133	3 62	7 135	6 70	9 163	9 143	—	—	—	—	—	—	—	—	—	—	—	—	—
40-pr.	{ Full, I. { S.S. Blank, I. { L.S.	{ 27/8/67 17/12/61	1415	" "	5.75, 6.5	6.3	" "	" "	2	I. 6+PR. BL. 9 lbs.	15 131	5 57	14 138	5 70	17 163	20 157	—	—	—	—	—	—	—	—	—	—	—	—	—
20-pr.	{ Full, I. Blank, I.	{ 18/6/62 6/2/68	1195	" "	10 " 10.75	4.77	4.5	3.25	5	I. 40-PR. BL. 5 lbs.	15 131	5 57	14 138	5 70	17 163	20 157	—	—	—	—	—	—	—	—	—	—	—	—	—
12-pr.	{ Full, I. Blank, I.	{ 5/11/61 6/2/66	234-408 1195	" "	12.25, 12.75	" "	" "	" "	2	II. 40-PR. BL. 3 lbs. Blank	12 128	5 61	12 136	4 67	13 151	16 151	—	—	—	—	—	—	—	—	—	—	—	—	—
9-pr.	{ Full, I. Blank, I.	{ 5/11/61 5/11/61	409	" "	5.75, 6.25	3.77	4.25	2.5	5	I. 20-PR. BL. 2 lbs. 8 ozs.	26 134	12 69	22 133	11 79	30 168	30 145	—	—	—	—	—	—	—	—	—	—	—	—	—
13 or 9-pr.	{ Full, I. Blank, I.	{ 5/11/61 17/9/68	410 1288	" "	4.75, 5.25	3.02	" "	" "	2	II. " 1 lb. 8 ozs. Blank	50 142	{ 25 71 } { 27 77 }	50 155	23 86	53 178	64 166	—	—	—	—	—	—	—	—	—	—	—	—	—
6-pr.	{ Full, I. Blank, I.	{ 5/11/61 20/7/67	411 1415	13 oz. "	8 " 8.5	3.07	" "	" "	3	I. 12 PR. BL. 1 lb. 8 ozs.	70 154	{ 30 76 } { 32 78 }	63 156	28 86	72 178	80 166	—	—	—	—	—	—	—	—	—	—	—	—	—
15 lb. bags	{ L.G. R.L.G.	{ 5/11/61 20/7/67	1415	10 oz. "	6.25, 6.5	3.125 & 2.87	—	—	6	II. 12 or 9 PR. BL. 10ozs. Blank	100 150	{ 44 75 } { 48 79 }	83 155	46 89	108 179	129 178	—	—	—	—	—	—	—	—	—	—	—	—	—
Weight of packages empty											8 170	30	61	43	69	46	—	—	—	—	—	—	—	—	—	—	—	—	—

\* For 7-inch, 82 cwt.  
 † For 7-inch, 72 cwt.  
 ‡ With paper covers.  
 N.B.—Army Circular 774 directs the use of L.G. powder with B.L. rifled guns (L.G. in red paint being marked on the cartridge & 1908). Blank or Exercise R.L.G. and L.G. is used for Blank, and Blank or Exercise R.F.G. and F.G. may also, if considered advisable, where there is a surplus store, be used for blank charges.

*Drill Cartridges* are made of a wood cylinder covered with felt and placed in a leather case, the base of the cartridge is shod with copper, and they have dummy lubricators, the detached lubricators having gun-metal stalks and sockets ; the cartridge is marked in black, same as the service cartridge, viz., with the nature of gun and weight of charge. Loose, in numbers as demanded.

B.L. DRILL OF DUMMY CARTRIDGES.

Nature and Numeral.	Date of Approval.	§ of Changes in War Stores.	Length.	Material of Outside Cover.	No. of Hoops.	Lubricator, inside or detached.	Marks.	Remarks.
7", Mark I.* -	3/2/64	876	Length not laid down, but should correspond to that of the service cartridge by each.	Blue serge -	5	Detached	I. A. 110-PR. RIFLE GUN, 12 LBS.	
7", Mark II. -	14/3/67	1384		Leather -	5	Detached	II. 7-IN. B.L., 11 LBS.	
64-pr., Mark II.† -	24/2/66	1196		Leather -	6	Inside -	64-PR. B.L., 9 LBS.‡	
40-pr., for L.S., Mark I. -	3/2/64	876		Blue serge -	6	Inside -	I. A. 40-PR. RIFLE GUN, 5 LBS.	
40-pr., for L.S., Mark II. -	14/3/67	1384		Leather -	6	Inside -	II. 40-PR. B.L., 5 LBS.	
40-pr., for S.S., Mark I.* -	3/2/64	876		Blue serge -	5	Detached	I. A. 40-PR. RIFLE GUN, 5 LBS.	
20-pr., Mark I.* -	3/2/64	876		Blue serge -	5	Inside -	I. A. 20-PR. RIFLE GUN, 2 LBS. 8 OZS.	
20-pr., Mark II. -	14/3/67	1384		Leather -	5	Inside -	II. 20-PR. B.L., 2 LBS. 8 OZS.	
12-pr., Mark I.* -	3/2/64	876		Blue serge -	4	Inside -	I. A. 12-PR. RIFLE GUN, 1 LB. 8 OZS.	
12-pr., Mark II. -	14/3/67	1384		Leather -	4	Inside -	II. 12-PR. B.L., 1 LB. 8 OZS.	
9-pr., Mark I.* -	3/2/64	876		Blue serge -	3	Inside -	I. A. 9-PR. RIFLE GUN, 1 LB. 2 OZS.	
9-pr., Mark II. -	14/3/67	1384		Leather -	3	Inside -	II. 9-PR. B.L., 1 LB. 2 OZS.	
6-pr., Mark I.* -	3/2/64	876		Blue serge -	3	Inside -	I. A. 6-PR. RIFLE GUN, 12 OZS.	
6-pr., Mark II. -	14/3/67	1384		Leather -	3	Inside -	II. 6-PR. B.L., 12 OZS.	

\* Cartridges similar to these, except that the diameter was larger (which caused inconvenience), were approved in May 1863, § 761, but no patterns of them now exist.

† § 1196, gives this as I.; the scaled pattern however was altered about 6/3/66 to II.

‡ Originally marked 8 lbs.; altered to increased charge of service cartridge, 24/10/69. See § 1840.

Issue.

GAUGES FOR RIFLED CARTRIDGES.

Gauges are of two sorts, viz. :—

1st. Brass ring for diameter.

2nd. Wood sliding for length.

Gauges filled, cartridges brass, ring, rifled gun (B.L.).

(1.) Brass ring gauges for diameter,—

High gauges only are necessary. They consist of rings of gun-metal with straight handles; they are marked on and near the handle with the designation and numeral, also the diameter, and the words "FILLED CARTRIDGE."

Designation and Numeral.	Date of Approval.	§ of Changes in War Stores.	Diameter.
7" B.L., II.* - - -	1/9/68	1695	7·05
64-pr. B.L., II.* - - -			6·3
40-pr. B.L., II.* - - -			4·84
20-pr. B.L., II.* - - -			3·84
12 or 9-pr. B.L., II.* - - -			3·07
6 pr. B.L., II.* - - -			2·57

*Issue.*

Issue.

Gauges are issued loose, in numbers according to demand.

(2.) Wood sliding for length,—

Gauges, filled cartridges, wood length, rifled B.L. § 1993.

These have not been sealed for any calibre except the 64-pr., but unsealed patterns exist for all; they are used in making up cartridges; each one consists of an open frame with a cross piece, with certain play (for which *vide* below) allowed as limit of error. The cartridge is passed beneath to test its length.

7" B.L. (for 11, or 10 lb. cartridge)	Limits 10" to 11".
64-pr., 9 lb.	" 10·75" to 11·25".
40-pr., 5 lbs. L.S. (formerly for 64-pr., 8 lbs.)	" 12·25" to 12·75".
40-pr., 5 lbs. S.S., and 20-pr., 2 lbs. 8 ozs.	" 10" to 10·75".
12-pr., 1 lb. 8 ozs.	" 8" to 8·5".
9-pr., B.L. 1 lb. 2 ozs.	" 6" to 6·5".
6-pr., 12 ozs.	" 6·25" to 6·5".

*Issue.*

Issue.

Loose, in numbers according to demand.

*Experience.*

*As to keeping Cartridges in Store.*

This subject includes two different sets of conditions :—

- 1st. The keeping of filled cartridges.
- 2nd. That of empty.

1st. *Filled Cartridges* are generally packed in cases, which, when properly closed, protect them from deteriorating action from outside, whether

\* Gauge I. is destroyed.

the ravages of insects or the entrance of wet. If, however, it is not luted round its lid properly, or if it is occasionally opened, a case contains the same moisture as is present in the air of the magazine, and this may be sufficient to cause deterioration, especially in the case of the old pattern B.L. cartridges, having the paper socket and unvarnished paper cylinder; for experience has shown that both the paper cylinders and paper sockets for the lubricator stalks foster the lodgment and quicken the deteriorating action of damp. It appears that the paper rapidly absorbs any moisture present in the atmosphere, and when this has occurred its contact with the powder causes it so rapidly to decay that in extreme cases it becomes reduced to pulp dust. In such a case the powder of the charge may still appear to the eye to be little or not at all affected. Sometimes it is difficult to detect deterioration in any way, but occasionally the grains separate into dust at the touch; in all cases, saltpetre being found present in the paper, the powder must have lost in strength.\*

This evil has, it is hoped, been remedied by varnishing the cylinder and replacing the paper sockets by wooden ones (*vide* pages 129, 130).

Cartridges carried in the limbers of field batteries have suffered from grains of powder finding their way up between the edge of the lubricator and the cartridge; and grains so situated cause lumps which wear the serge through and form holes, through which the powder may gradually work out. For this reason it is desirable that the lower edge of the lubricator should be as nearly opposite the upper edge of the first braid hoop as possible.

2nd. *Empty Cartridges* suffer chiefly from the ravages of moth and other insects. As long, however, as they are kept compressed tight in their calico bales it appears that they are not attacked;\* and this should be borne in mind in storing them, especially as all the attempts made to protect them by impregnating the serge with corrosive sublimate,† wood naphtha, and carbolic acid,‡ have proved unsuccessful.

\* *Vide Extracts*, Vol. IV., p. 383.

† " " Vol. III., p. 170, and Vol IV., pp. 171 and 292.

‡ " " Vol. IV., pp. 293, 382, and 383.

## CHAPTER XII.—AMMUNITION FOR R.M.L. GUNS AND HOWITZERS OF 7" AND UPWARDS.

COMMON, DOUBLE, AND SHRAPNEL SHELL.—PALLISER SHELL AND SHOT.  
CASE SHOT.—GAUGES.—CARTRIDGES, AND STORES CONNECTED WITH THEM.

### THE WOOLWICH SYSTEM.

Woolwich system.

The Woolwich system, so called, is nearly identical with one adopted by the French.\* It owes its designation to the fact that some name of general signification was thought desirable, and "Woolwich" was chosen on the precedent of the Enfield rifle, which was called after its place of manufacture, and was not connected with the name of any individual.

This system embraces uniform and increasing twists; in both cases the rifling is given by studs moving in three or more grooves.

Increasing and uniform spiral.

The increasing twist is preferred † chiefly because the strain on the

\* The 7-inch experimental gun, rifled on the French system, tried in competition with guns with Commander Scott's, Messrs. Jeffrey and Britten, and Mr. Lancaster's rifling, had three grooves .25 inches deep, 2.09 inches wide, with a twist increasing from zero up to one turn in 259 inches, or 37 calibres.—Extracts, Vol. II., pp. 289, 290.

† The Ordnance Select Committee say:—

"The supposed advantage of the increasing spiral is that the projectile having at the moment of leaving its seat only to move directly forward gets away from the powder charge more readily than when, as in a gun with a uniform spiral, it is forced simultaneously into rotatory motion; somewhat more of the powder is therefore consumed before the shot moves in the latter than in the former case, and therefore the total force acting on the projectile during its passage through the bore is somewhat greater, and hence a somewhat greater velocity at the muzzle. . . .

"The blow struck by the one shot on leaving the muzzle would be to that struck by the other as 100 to 103.

"*Recoil.*—It was found that these guns would run off the ordinary platforms if fired without compressors; it was therefore impracticable to compare their recoils, because any measure of actual distance run back when compressors are used is only a measure of the goodness of the compressor or the strength with which it is hove up.

"*Easiness of loading.*—Both guns were loaded with ease, and there was no difference between them in this respect.

"*Condition of vent.*—The gutta-percha impressions show a small but decided difference between the wear of the two vents. That of the gun with uniform spiral is most enlarged.

"*Cost.*—There is no difference in the cost of rifling these guns, but there is 8 ozs. less metal in the studs for the gun with increasing spiral as now made, and each of its shot will cost 10d. less than those for the other gun. It is possible that the leading stud of the gun with uniform spiral might bear an equal reduction without affecting the shooting.

"*General results.*—This difference of cost is too small to be worth consideration if any other reason determined the choice, and as the guns are practically equal in range and accuracy, the question is narrowed to that of whether it is worth while to sacrifice 3 per cent. of the *vis viva* at the muzzle for the sake of a small relief to the powder chamber. Sir W. Armstrong has always insisted much upon the necessity for relieving the breech of the guns in heavy natures, but he attains his end by distributing the powder charge, and as the Committee are persuaded that the theoretical reasons in favour of an increasing twist are sound ones, and in some measure confirmed by the practice now reported, although it has not evinced a superiority in accuracy, they adhere to the opinion expressed in their former report.

"Colonel Younghusband records his dissent from the opinion of the majority of the Committee, and does not consider the adoption of an increasing spiral as warranted by the present comparison."

*N.B.*—The mean velocities were 1440.7 feet and 1465 feet.



gun and consequent wear\* is less; it also has a slight advantage in Uniform accuracy of fire, although a rather lower initial velocity. In accounting spirals. for these effects with the increasing twist, it may be well to consider very briefly the entire question.

The object is to get the maximum velocity that can be given to the shot without imposing an intolerable strain on the gun. Now, as noticed before, with large calibres the main difficulty is to keep this strain and consequent wear and tear on the gun under control; that is, to make the piece last a reasonable time. Hence it is desirable to attain this end, even at the sacrifice of powder, and this is precisely what is effected by the adoption of the increasing twist, instead of the uniform; for on the latter system the projectile can only move forward after rotation has been imparted to it by the indirect resistance of the driving edges of the grooves against the studs; in fact, after resistance to rotation as well as inertia has been overcome, while with an increasing twist the projectile moves forward as soon as its inertia is overcome, and the rotation is imparted gradually during its passage through the bore.

To compare the two systems it is advisable to take the case of projectiles leaving both guns with the same velocity, when, it stands to reason, both shot having the same "work done" on them, both guns must also have the same "work done" on them, and the entire value of the increasing system depends on the shape in which this work is performed. Now it appears that "work" may be "done" on the particles of the mass among each other, or equally on the whole as a rigid body; thus, when the force acts too quickly to develop any recoil, it is obvious that it has acted on the particles among themselves, which may be supposed to be vibrating from elasticity, or else permanently crushed, and this may be considered generally to be the nature of destructive effect; but when a force acts more gradually on a gun, the whole mass recoils more rigidly, and less destructive effect takes place; in short, the "work done" on a gun is shown by recoil and destructive effect; and the more gradually the work is performed, in plain words, the more it becomes a push rather than a blow, the more recoil and the less destructive effect is produced.

This, then, is the nature generally of the work developed by an increasing as compared with a uniform twist, and it is reasonable to conclude that where comparison was made in the cases of two projectiles of equal initial velocity, the gun with the increasing twist would have the greater recoil.

This method of performing the work gradually, by the increasing spiral, however, necessitates the expenditure of more powder, because the shot moving more readily, less gas is generated before it commences to move, and since the pressure of this gas is in inverse proportion to the space it occupies, it acts with less and less power as the space behind the

---

\* "It will be seen that in point of accuracy of fire, taken on a general average, the increasing spiral has the advantage, the uniform spiral gun has a higher initial velocity and consequent length of range, but the difference is not sufficient to be of any practical importance. Being still persuaded that the theoretical reasons in favour of an increasing twist are sound ones, that a system of rifling which admits of the projectile moving directly forward from its seat at the moment of ignition of the charge must be more favourable to endurance than one which, by impeding the first movement of the shot in the bore, narrows the space for the expanding gas, and consequently brings a greater pressure on the breech of the gun, the Committee as a body have no hesitation in recommending that it be adopted for 8-inch guns of 9 tons, and combined with four grooves of the Woolwich form, viz., width, 1.5 inches; depth, .18 inches. Mean initial velocities, increasing 1303.3 feet a second. Uniform, 1338.6 feet.—Extracts, Vol. IV., p. 253, 2/7/66. Also opinion repeated, Vol. III., p. 325, and vol. v., p. 18.

shot gets larger and larger, and in addition to this, the shot being already in motion, the pressure becomes dependent on the difference between the velocity of the gas itself and that of the projectile in front of it.

Uniformly increasing spiral.

Every increasing spiral in the service is what is termed "uniformly gaining;" that is, suppose the bore to be cut across into any number of equal lengths, each successive one as the shot passes through it gives the same addition to the twist.

Before entering into details as to the studs and grooves, it may be remarked that the work they perform may be limited to imparting rotation to the projectile, or it may include giving it direction also, according to whether there is more windage over the top of the stud in the groove, or over the body of the projectile in the bore. In the former case the shot lies in the bore, and is spun by its buttons; in the latter it lies and moves through the bore on its buttons, whose faces are the medium through which direction is given, while their driving edges impart rotation.

Action of studs.

In all Woolwich guns both the direction and twist are given by the bearing of the studs on the grooves, the body of the shot never being intended to come into contact with the bore, so that, in fact, the action of the latter is merely to confine the gas and keep it behind the projectile, which is made with a windage of  $\cdot 08''$  in all calibres.

Before entering on the details of the ammunition it is necessary to point out the meaning of a few of the terms used in connection with studded projectiles.

Clearance.

*Clearance.*—If the depth of the groove is less than the projection of the stud beyond the body of the shot there will be "clearance," that is, there will be an interval between the body of the shot and the bore of the gun, and consequently the shot will rest entirely on the studs, the amount of clearance will be the difference between the depth of groove and the projection of the stud, thus in some of the Woolwich guns the depth of groove is  $\cdot 18''$ , the projection of stud is  $\cdot 195''$ , therefore there is a clearance of  $\cdot 015''$ , this is the mean clearance, and is liable to be reduced by manufacturing limits. With iron guns it is not generally considered of much importance to have clearance, but where bronze is used it becomes essential, as the iron projectile would injure the softer metal of the gun. If, on the other hand, the depth of the grooves was greater than the projection of the stud, the metal of the projectile would be in contact with the bore of the gun; in this latter case the studs only serve to twist the shot, whereas in the former they give it both direction and twist.

Centring.

The projectile in loading bears on one side of the stud which is called the "loading edge;" on firing, it bears against the other side, which is called the "driving edge;" if the sides of the studs be perpendicular to the projectile, or to speak more correctly, normal to its surface, and the groove be of a corresponding shape, the stud will remain at the bottom of the groove, but if the side of the stud be made an inclined plane, and the side of the groove corresponding in shape, the stud on being pressed against the groove will have a tendency to run up the inclined plane, and by so doing will centre the shot in the bore, that is, will bring the axis of the shot to correspond with the axis of the gun; the windage will in this case be evenly distributed all round the shot, and the shot will not be in contact with the bore, hence with bronze guns centring is desirable, as even with a groove of a depth equal to the height of the stud there would be no contact.

In the Woolwich system the rotation is given by studs made of an alloy of copper and tin, 10 parts of copper to one of tin; they are secured to the projectiles by being pressed into undercut holes.\*

The depth of the groove is in the later patterns of guns up to the 9"·18" in the larger guns, the depth is ·2", the bottom of the groove is circular, but struck with a radius of 3", so in no case is the bottom of the grooves concentric with the bottom of the gun (this entails the necessity of planing the face of the studs instead of the simpler operation of turning), the edges of the grooves are circular, struck with radius of from ·3" to ·25", according to the nature of the gun; the width of the groove is 1·5", the studs are formed with faces and shoulders corresponding to the grooves, they project ·195", up to the 9", and ·215" in the larger shells beyond the body. The width of the rear stud is 1·42", that of the front stud is limited by the amount of twist of rifling at the muzzle.

From the above dimensions of grooves and studs it will be seen that there is a clearance of ·015", practically there is no centring, the play between side of stud and side of groove is ·08", the windage is ·08" over the body and ·05" over the studs.

As to the number of studs, two to each groove seem to be necessary to carry out the above principles, and the fact that surprisingly good results have been obtained with only one, simply shows how little practically depends on the centring principle,† and on the decrease of ·03 inches of windage, where gun-metal bearings perform such sudden and violent work; for a shot with a single stud which is not opposite its centre of gravity must lie partly on the rear stud in the groove, and partly on the front portion of the body in the bore, the rear portion, having ·05" windage and a gun-metal bearing on iron, and the front ·08" windage and iron bearings. This then is its condition of rest, but when it commences to move the forces become complicated with shot of the service form, for the metal in the ogival head is placed so as to tell more on the balance of the shot, that is, on the position of its centre of gravity, than a similar quantity of metal in the base, while being placed nearer the axis of the piece it gives less resistance to rotation, hence the part where any force applied to spin the shot would meet with equal resistance on each side of it would not be opposite to the centre of gravity.

In point of fact, four centres may be taken in the longer axis of a projectile on different principles:—

- 1st. A point bisecting the longer axis, commonly called the centre of the figure.
- 2nd. The centre of gravity on which the shot would balance.
- 3rd. Such a point that a plane section passing through it at right angles to the longer axis would divide the metal into equal volumes or weights.

---

\* Studs were formerly screwed into the shells, but pressing them is more economical, and though it entailed using softer metal, the shooting was found to be equally accurate. At first an alloy of seven of copper to one of tin was employed, but the softer alloy was found necessary in the 7-inch, where pressing in the stud occasionally split the shell; its use was extended to Palliser projectiles in 1870, and subsequently (8/3/72) was extended to all projectiles from 7-inch, inclusive, upwards. A pressure of about 30 tons is required to press the stud into the 7" shell.

† Extracts, Vol. VII., pp. 141, 243.

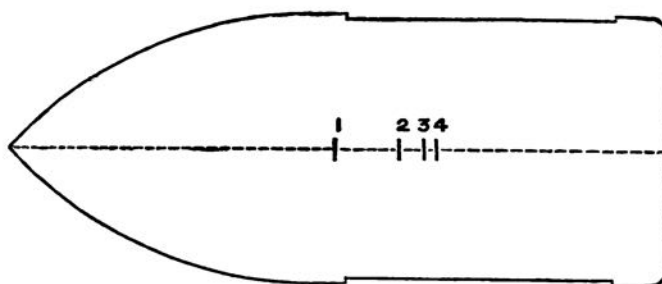

4th. Such a point that a plane section passing through it at right angles to the longer axis divides the projectile so that the "work done" in giving rotation is the same on each portion.

These points will probably be found in the above order, reading from point to base in service projectiles, and unless the base be made symmetrical with the head, they can never all coincide.

It has been said that practically projectiles shoot well with one ring of studs only, but a small number of rounds as yet have been fired, and it remains to be seen whether the bore suffers from this treatment. The advantage of firing projectiles with a single ring of studs would be great in some cases, for the projectile would be available for any pitch of groove. The front studs in all the service projectiles project the same amount as the rear ones, so as to keep the axis of the projectile parallel to, although, as has been noticed, not mathematically, coincident with, that of the bore; then as to rotation, with a uniform twist the front studs exactly resemble the rear ones, and both together drive the shot throughout its passage up the bore, but with the increasing spiral this is impossible,\*

Front studs  
with increasing  
twist.

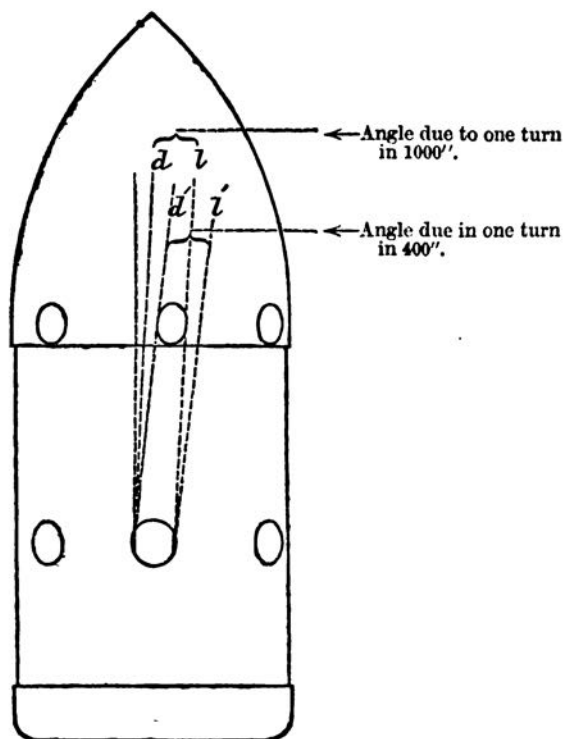

\* In the French system of increasing twist the front stud was the full size and the rear one reduced, but this appears inferior to the opposite arrangement for more than one reason.

for the groove runs nearly longitudinally along the projectile at the bottom of the bore, while it crosses it at almost the angle due to the full rate of rotation before the front studs clear the grooves at the muzzle, hence it follows that there is only a very much narrowed strip of the projectile that comes opposite to the groove in both its extreme positions, which are roughly shown in the annexed figure. The rear stud being of the dimensions given above, it will be seen that the front stud must be reduced to remain opposite to the groove in all positions, and it is therefore necessarily limited in its breadth to enable the shot to pass down the bore; for to enter the grooves *d' l'* at the muzzle the front stud must not extend to the left of the edge *d'*, while to admit of being rammed home it must not extend to the right of the edge *l*. The exact breadth will of course vary with the circumstances of each case, and cannot therefore be laid down here.

Thus the front stud touches the driving edge *d'* on entering the bore, and the loading edge *l*, when well home; and the reverse action occurring in firing the share it takes in the work of rotation is very small, for until the driving edge meets it, the whole pressure is on the rear stud, indeed it is only owing to the wear of the latter that the former comes in contact with the driving edge of the groove before it reaches the muzzle, and it has even been doubted whether it actually does so, but an inspection of the front stud\* of recovered shot bears out the statement that a certain part of the work of rotation falls on it although the chief use appears to be to steady the projectile.†

Two rings of studs have not been found sufficient for the Palliser projectiles of the 12-inch 35-ton gun, in some cases the front ring of studs was shorn off; this has been remedied by inserting a second ring midway between the front and rear ring. It has also been found advisable to add a third ring of studs to the common shell for those guns, as two were found insufficient when battering charges were used. § 2490.

The longitudinal position of the studs has now been fixed as follows: Longitudinal position of studs. The centre of the rear stud is to be not less than four inches from the base of all projectiles.†

The front and rear studs are to be at equal distances in front and rear of the centre of gravity of the projectile, except in the case of Palliser cored shot, and are to be the same distance apart on all projectiles for the same gun.§

The rear stud has been moved forward to suit the navy || who use a

\* The Superintendent (Shoeburyness) remarks that "on examination of the shells after being recovered, the front stud was found in every instance to have been worn away on the driving side, showing that it had come into bearing." The same effect was seen even when the front stud was "very much reduced in size."—Extracts, Vol. III., p. 156, 5/6/65 and 7/6/65.

† On experiment with front studs still further reduced in size. "On this occasion the reduction in the size of the front studs was effectual, those on the recovered shell showing no symptoms of having touched the driving side of the groove. The practice is very nearly as good as that reported in June, and inclines the Committee to the conclusion that the use of those studs is to steady the shot in the bore and not to rotate them."—Extracts, Vol. III., p. 256, 24/7/65.

‡ Fixed by a letter from Ordnance Select Committee to Superintendent Royal Laboratory, dated 12/9/67. In the Palliser 7-inch the distance is 3.77 inch.

§ In all the projectiles of the same calibre, the front and rear stud shall be placed (as far as practicable) at one uniform distance from each other. § 1518.

|| A letter from Capt. Hood, R.N., H.M.S. "Excellent," 21/3/67, forwarded to the Ordnance Select Committee, says, "That the bearing actually necessary to sustain the weight of the shell in the muzzle when lodged for the purpose of turning it for the entry of the studs into the grooves is, in the case of the 7-inch gun, 1'5", and in that of the 9-inch, 1'75". He therefore considers "that these distances are the least that can be allowed from bottom of projectile to studs."—Ordnance Select Committee, Min. 21, 430, subject No. 2424 (Ordnance Select Committee Proceedings).



canvas bearer in loading, which does not bring the projectile up to the muzzle of the gun (like the land service bearer), with its studs opposite the grooves, but in an accidental position; it is therefore convenient to rest that part of the base which is clear of studs in the bore, and thus relieved of the weight of the projectile, to turn it round until its studs come into proper position.\*

The question arises of how this advanced position of the rear stud affects the shooting; this has of course been tested, and it has been found by practice that no harm results from it, indeed, as to direction, it stands to reason that the large stud in rear should be as near as if not nearer to the centre of gravity than the front one, while as to rotation with the increasing twist it seems still a question whether the rear studs, which perform the main part of this work, would not still better effect this purpose if placed much more nearly opposite to the centre of gravity.†

§ 1518.

Placing the studs at a uniform‡ distance apart on all projectiles of the same calibre simplifies gauging, which otherwise becomes complicated in the case of an increasing twist. This plan entails one gauge only to test the edges of the studs of each calibre (*vide* page 148).

### *Length.*

Length of  
projectiles.

This necessarily varies in the different descriptions of projectiles for the same gun, inasmuch as it is to some extent subordinate to the consideration of bringing them all (with certain exceptions) to the same weight, but it has been decided that a length of two calibres§ at least is necessary for very accurate shooting, and it is desirable for good “vis

\* It has been thought advantageous to lift the shot and enter its base in the bore and turn it to its required position in preference to hooking the shot bearer on the muzzle in serving these guns on land as well as on board ship.

† There is an advantage in having the studs a considerable distance apart, as any unequal wear on the bearing surfaces will alter the position of the shot less than when the studs are near together.

‡ As nearly as possible equidistant from centre of gravity, and at the same distance from one another in the same calibre so as to allow one gauge to be used for all.—*See Report (Ordnance Select Committee Proceedings)*, 4666, *Minute* 22,679, date, 30/7/67.

§ Capt. (now Admiral) Key, of H.M.S. “Excellent,” in a letter, says, “He has fired both shell and shot from a 64-pr. muzzle-loading gun without detecting any difference between them as to accuracy or range; the short solid shot were very inferior to both.”—*Extracts*, Vol. III., p. 35.

¶ He (Professor Bashforth) desires to call the Committee’s attention to the superior accuracy of shell over shot in the trials with guns of various degrees of twist, from which it appears that the increased length of projectile tended to increased steadiness.” (*Extracts*, Vol. III., p. 70.)

“Experience has led the Committee to conclude that to attain very accurate shooting the projectiles of M.L. guns must not be less than two calibres in length. It has been observed that the shooting of common shell is almost invariably better than that of segment shell or common shot. This difference is attributed partly to their length and partly to the favourable conditions of the hollow form, by which the centre of gyration is thrown further from the axis of the projectile. The one condition points to elongating the shot, and the other to making it hollow, and inasmuch as cast-iron hollow shot of moderate thickness are strong enough for all battering purposes for which cast-iron projectiles are likely to be used, while they have the further advantage of being easily convertible into battering shells, the Committee propose the introduction of hollow instead of solid shot, and to make these shot of such weight as will give a length favourable to accurate shooting. This weight will also give a greater *vis viva* at a given distance than a lighter and consequently a shorter shot fired with a larger charge. There will therefore be economy in the stowage and quantity of gunpowder, combined with increased efficiency, in a system based on the foregoing principle (*Extracts*, Vol. III., p. 128).

“Recent experience has led the Committee to conclude that to attain very accurate shooting the projectiles of muzzle-loading rifle guns must not be less than about two calibres in length, and inasmuch as a solid shot of a weight consistent with the safety of the gun will not fulfil this condition, it became necessary to look for a more favourable form.”—*Extracts*, Vol. III., p. 128.

viva" or destructive effect on impact at any but very short ranges to have the weight great in proportion to the calibre, or in fact to the surface of resistance, and of course this is favoured by an increased length of projectile.

The question of hollow shot in place of solid connects itself with this, indeed a solid shot of two calibres long would in some cases exceed the desired weight for each gun, but besides the consideration of external form, the hollow shot, having its weight distributed further from its axis, has a slight advantage in having a longer radius of gyration and greater power of keeping up its rotation, though entailing a slightly increased strain on the gun. It will be seen, however, that this question only arises with reference to Palliser shot, case being the only other description of shot for Woolwich guns.

The form of head is governed by two considerations, flight and penetration, and this latter, which gives different\* forms in different instances, will be discussed in detail. The question of flight affects all equally, and on this experiments† have been made which resulted in the adoption of what is termed an ogival head, struck with a radius of 1.5 diameters for common shell of all calibres.‡ §

Form of head.

\* A letter from the Ordnance Select Committee, 13/11/65, to the Superintendent, Royal Laboratory, gives forms for the heads of shells and shot for Woolwich guns nearly approaching those now in the service.

† Of the forms tested as to the resistance they meet with in flight, viz., No. 1 nearly parabolical (service form), No. 2, hemispherical, No. 3, parabolical, focus  $\frac{1}{2}$  diameter; 4, equilateral cone; 5, ogival, radius two diameters. The Ordnance Select Committee report "that the conoidal or ogival form is superior to either of the above, and the fronts of any new shot introduced into the service should approximate to this form as nearly as is compatible with suitability for the service in other respects."—(Extracts, Vol. II., p. 305.)

Much information on this subject will be found in the Reports on Experiments with the Bashforth Chronograph, 1865–1870, p. 10, 166, and also in Professor Bashforth's Treatise on the Motion of Projectiles. On p. 30 it is stated that the resistance of the air to the hemispheroidal and to the ogival heads (struck with radii of 1 and 2 diameters) varied so little that it was plain that any of these forms most serviceable in other respects might be adopted; the slight variations in the resistances lead to the conclusion that the amount of resistance offered by the air to the motion of elongated shot is little affected by the more or less pointed apex, but depends chiefly on the form of the head near its junction with the cylindrical body of the shot. The resistance to a hemispherical headed shot was much greater than to the above forms. See also Tables of Velocity, Time of flight and Energy, published by Spon, Charing Cross. On p. 12 it is stated that at a velocity of 1,100 f.s., the loss of velocity of a flat headed shot is to that of an ogival headed shot as 80 to 63.

‡ The construction of ogival heads of radii of 1,  $1\frac{1}{2}$ , and  $1\frac{3}{4}$  diameters respectively may be seen in the figs. 1, 2, and 3 below.

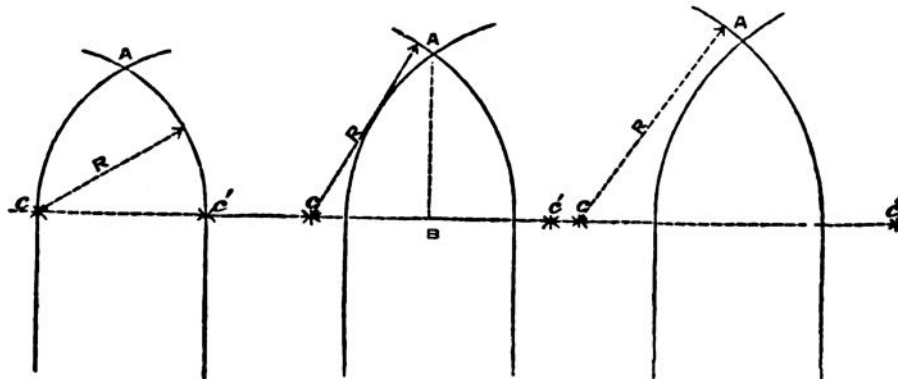

Fig. 1.

Fig. 2.

Fig. 3.

C and C' being the centres, and R the length, of the radii, in each case.

[cont.]

§ See next page.

33683-

K

Form of base.  
§ 1599.  
§ 1765.

To facilitate loading at sea with the canvas bearer noticed above, the bottoms of the more recent patterns of all projectiles, case excepted, are rounded; all, except shrapnel, with a circle of 1 inch radius, Shrapnel vary in this respect, as noticed in details hereafter given.

Before dealing individually with each projectile, it may be well to observe such distinctive features as necessarily spring from the rifling of the gun, and are therefore common to all the projectiles taking the grooves of each gun, in other words, all except case shot; it will be sufficient to notice these once for all, and will save vexatious repetition.

It may be observed in the case of  $1\frac{1}{4}$  diameters radius (fig. 2) that the head is exactly 1 calibre long—

$$\text{For } (CA)^2 = (CB)^2 + (BA)^2 \\ \text{i.e. } (BA)^2 = (CA)^2 - (CB)^2.$$

or, in terms of the diameter or calibre—

$$BA^2 = \frac{25}{16} D^2 - \frac{9}{16} D^2 \\ = \frac{16}{16} D^2 \\ = D^2$$

$$\text{or, } BA = D$$

that is, BA the length of the head = 1 calibre.

§ Captain Browne states:—Having found the volumes of the service forms of ogival heads by integration, and the results having been worked on with slight modification in the Department, I give them on the possibility of their being required, when much calculation will be saved by adopting them.

Taking D as the diameter of the shot, the volumes of the solid heads are as follows:—

With an ogival head of 1 diameter radius—

$$\text{the vol. of the head} = D^3 \times .395592 \quad - \quad \text{I.}$$

with an ogival of  $1\frac{1}{4}$  diameters—

$$\text{the vol. of head} = D^3 \times .44765 \quad - \quad \text{II.}$$

and with an ogival of  $1\frac{1}{2}$  diameters—

$$\text{the vol. of head} = D^3 \times .49425 \quad - \quad \text{III.}$$

In the Laboratory drawing office for some reason that I cannot explain the decimal II. was altered to .4478, and III. to .4944, which were thought to give better results, but appear to be less correct mathematically. Col. Maxwell has also worked out these heads and obtained the same decimals as myself.

The calculations to obtain the above are of course tedious, the equations, integrals, and general results are as follows, taking the origin in the axis of the head:—

For I. Where R (the describing radius) = D.

$$R^2 = x^2 + \left(y + \frac{D}{2}\right)^2$$

$$\text{and vol.} = \pi \int_0^{D \sin 60} \left( D^2 - x^2 - D\sqrt{D^2 - x^2} + \frac{D^2}{4} \right) dx \\ = \pi \left\{ D^2 x - \frac{x^3}{3} - D \left( \frac{x}{2} \sqrt{D^2 - x^2} + \frac{D^2}{2} \sin^{-1} \frac{x}{D} \right) + \frac{D^2}{4} x \right\}$$

For II. Where R =  $\frac{5}{4} D$

$$R^2 = x^2 + \left(y + \frac{3D}{4}\right)^2$$

$$\text{and vol.} = \pi \int_0^D \left( \frac{25}{16} D^2 - x^2 - \frac{3}{2} D \sqrt{\frac{25}{16} D^2 - x^2} + \frac{9}{16} D^2 \right) dx \\ = \pi \left\{ \frac{25}{16} D^2 x - \frac{x^3}{3} - \frac{3}{2} D \left( \frac{x}{2} \sqrt{\frac{25}{16} D^2 - x^2} \right. \right. \\ \left. \left. + \frac{25}{32} D^2 \sin^{-1} \frac{4}{5} \frac{x}{D} \right) + \frac{9}{16} D^2 x \right\}.$$

[cont.]

The characteristics then of each gun to which their relative projectiles necessarily correspond are as follows:—\*

12" gun, 35 ton, 9 grooves; twist; increasing from 0 to 1 in 35 calibres at muzzle.†

12" gun, 25 ton, 9 grooves; twist; increasing from 1 in 100 to 1 in 50 calibres.

11" gun.‡ 9 grooves; twist; increasing from 0 to 1 in 35 calibres at muzzle.

10" gun. 7 grooves; twist; increasing from 1 in 100 to 1 in 40 calibres at muzzle.

9" gun. 6 grooves; twist; increasing from 0 to 1 in 45 calibres at muzzle.

8" gun.† 4 grooves; twist; increasing from 0 to 1 in 40 calibres at muzzle.

7" gun. 3 grooves; twist; uniform 1 in 35 calibres.

The 7" gun has a uniform twist, because the Admiralty at the time of its introduction preferred the uniform to the increasing spiral.§

The following properties are common to the projectiles of each calibre, and may be assumed where the reverse is not stated, and as they vary with the calibre, it would cause confusing and vexatious interruptions to introduce them all under the head of each description of projectile:—

The various projectiles for each calibre of gun are generally brought to the same weight (except case shot and double shell). It has not, how-

For III. Where  $R = \frac{3D}{2}$

$$R^2 = (y + D)^2 + x^2$$

$$\text{and vol.} = \pi \int_0^{\sqrt{\frac{5}{2}} \frac{D}{2}} \left( \frac{9}{4} D^2 - x^2 - 2D \sqrt{\frac{9}{4} D^2 - x^2 + D^2} \right) dx$$

$$= \pi \left\{ \frac{9}{4} D^2 x - \frac{x^3}{3} - 2D \left( \frac{x}{2} \sqrt{\frac{9}{4} D^2 - x^2 + D^2} + \frac{9}{8} D^2 \sin^{-1} \frac{2x}{3D} \right) + D^2 x \right\}.$$

The above are good for their own form of head. Professor Bashforth, however has furnished me with a general formula applicable to all ogival heads.

$$R^2 = (x - a)^2 + (y - b)^2.$$

$$\text{vol.} = \pi \int_0^{\sqrt{R^2 - b^2}} \left( \sqrt{R^2 - x^2} - b \right)^2 dx$$

$$\text{vol.} = \pi \left\{ R^2 x - \frac{x^3}{3} - b \left( x \sqrt{R^2 - x^2} + R^2 \sin^{-1} \frac{x}{R} \right) + b^2 x \right\}.$$

It will be seen, taking the origin as before, that  $a = 0$ , and further that  $b = R - \frac{D}{2}$  in all cases.

If the value of  $R$  and consequently of  $b$  be taken according to the conditions of any of the above three cases, this general expression will become the particular equation given above.

\* 13" gun, now naerly obsolete, 10 grooves; twist; uniform; 1 in 55 calibres.

† For S.S. only.

‡ For L.S. only.

§ O.S.G., Vol. iii., p. 227, Minute 16,625.

ever, been found practicable to do this in all cases. The 12-inch 25 ton gun has an exceptionally slow twist, therefore a long projectile can not be fired from it, hence the weights of the common and Shrapnel shell are much less than those of the Palliser projectiles.

The 12-inch, 35 ton gun has a twist as rapid as the majority of Woolwich guns, but even with this twist it would be impossible to lengthen the common shell or Shrapnel, so as to bring them up to the weight of the Palliser projectiles, which is exceptionally heavy for a of that calibre. By reference to the table, p. 152, it will be seen that the common shell is nearly three calibres in length, beyond which it is impossible to go without injuring the shooting qualities of the shell.\* The weights of the Palliser projectiles are given below, the weights of the other projectiles (except double shell and case shot), approximate closely to those of the Palliser projectiles, except for the guns of 12 inch calibre.

The weights are as follows† :—

12 inch, 35 ton,	-	-	700 lbs.
12 „ 25 ton,	-	-	600 „
11 „ -	-	-	530 „
10 „ -	-	-	400 „
9 „ -	-	-	250 „
8 „ -	-	-	180 „
7 „ -	-	-	115 „

The constant distance between the front and rear stud adopted for all the projectiles of each calibre in the more recent patterns, as mentioned at page 144, is as follows :—

For the 12" 35 and 25 ton guns it is	7"
„ 11" „ „ „	8"
„ 10" „ „ „	8"
„ 9" „ „ „	6"
„ 8" „ „ „	5"
„ 7" „ „ „	4·6"

The projectiles for each gun may be recognised by the calibre being cast on the base, the weight of gun is also given for the 12 inch projectiles. Shell cast prior to 1873 are not thus marked, but they may be known by the number of studs in each ring except in the 11 inch and 12 inch which have the same number of studs. The number of studs in each ring is as follows :—

12 inch, 35 ton†	} 9
12 „ 25 „	
11 „ -	} 7
10 „ -	
9 „ -	- 6
8 „ -	- 4
7 „ -	- 3

\* This applies to guns with such an amount of twist as is given to them in our service, the length of shell depends directly upon the amount of twist, and we may say generally that the sharper the twist the longer the projectile may be.

† The 13-inch projectiles approximated in weight to 600 lbs., they are ordered to be broken up.

‡ Any 12" 35 ton projectiles issued before 3/73 will have "35 ton" stamped on the rear studs.



The projectiles now in the service for Woolwich guns are as follows:—

- a. Shell (viz., common, double, Boxer Shrapnel, and Palliser's).
- b. Shot (viz., Palliser's and case).\*

N.B.—Besides these, steel shot and shell (Alderson's), although obsolete, might possibly be met with.†

1. Common.
2. Double.
3. Boxer shrapnel.
4. Palliser's.

a. Shell.

1. *Common Shell.* (Calibres, 12", 11", 10", 9", 8", and 7".)

Common shell.  
Calibres.  
§ 2360.

Gauge, G. S. Fuze, Pettman G. S. percussion. (For S. S. the 9 and 20 seconds M. L., Mark I., time fuzes may be used when firing 14 lbs. charges from the 7 inch gun.) See plate, p. 332.

They are about three calibres long, except that for the 12 inch, 25 ton gun, for the reasons given above. All the shells have two extractor holes in the head; their interior is lacquered like other shells. They are to be completely filled with powder, but bags are invariably to be used. For method of filling, see p. 51.

The capacity, dimensions, &c., of the various patterns will be found in the table, p. 152.

The thickness of the walls varies, from about  $\frac{1}{2}$  in the larger, to about  $\frac{1}{8}$  of the diameter in the smaller shells. In the shell for the 12 inch 35 ton gun, the thickness of the walls increase slightly towards the base, the same plan is adopted in the shell for the 11 inch gun, and in Mark II. 10 inch shell, in the other shells the walls are of even thickness throughout.

Shells made between 1869 and 1873 have unloading holes, see p. 95.

All shell of late manufacture have the bases rounded off to facilitate loading.

The gun metal bush is countersunk about 0·2 inch in all, but a few of the earlier patterns where the countersink is only 0·1. These do perfectly well for L.S. but cannot be issued for S.S. which require a deep countersink to take the wad, see p. 97.

For S.S. loose.

Issue.  
§§ 2370, 2413,  
2421.

1. Filled and fuzed with Pettman G.S. fuze, over which is cemented in the wad, papier mâché fuze hole, Naval, with loop.
2. Empty with G.S. plug and wad, papier mâché, Naval, plain.

For L.S. Empty, loose, with G.S. plug.

Would be used against materiel generally, they would be most Use. destructive against wooden ships.

\* A 90 cwt. 7-inch gun has been introduced for S.S. The ammunition is the same as that for the heavier gun, except that it is not to be fired with Palliser projectiles and battering charges.

† Vide §§ 1297, 1118. Steel shot and shell had heads painted white, that of the shell had a red tip, the head was unscrewed to enter the bursting charge. Steel heads latterly were stamped S.

It will be remarked that only a percussion fuze, which acts on direct impact, is supplied. It is assumed in the L.S. equipment that the Woolwich guns will for the present only be found on sea fronts, therefore a fuze which will not act on striking water is necessary.\*

### *Experience.*

**Experience.** The risk of prematures, their importance, and the method of preventing them which has been found effectual, has been fully given on p. 25.

The studs have stood well, and the shooting of the common shell has generally been good. In some cases the practice has not been very good from the 9 inch gun when using full charges†, possibly the rotation is not rapid enough with the smaller charge.

The 10 inch shell altered its form, when fired, rather more than the other calibres, and experiments carried on against a target representing the side of a wooden ship indicated that a stronger shell was desirable‡; the walls were consequently thickened, and the capacity reduced. See table, p. 152.

The effect produced by the pressure on the sides of a R.M.L. common shell from the gas rushing past is found to be most remarkable, the shell having a tendency to assume a form approaching that of a dumb-bell. The base being solid transversely, is not appreciably compressed, but the end of the body close to the commencement of the head, although receiving considerable support from the latter, is acted on to some extent, while the body about the middle, where it is weakest, is forced inwards, and decreased in diameter to an extent which would hardly be credited.§

The lower side of the shell in the gun appears to be convex, and the upper concave; in the 10 inch the concavity has been found to be as much as 0·1 inch, and in one instance the shell in front of the rear stud was reduced from its original diameter of 9·92 inch to 9·84 inch.||

The shell have occasionally marks of scoring, showing that they have been in contact with the iron of the gun.

**2. Double shell.**

**2. Double Shell.**—Calibre, 7 inch, gauge, G.S. Fuze, Pettman G.S. percussion.¶ See plate, p. 333.

It is a shell nearly four calibres long, strengthened by three ribs internally, otherwise resembling the common shell.

A bag is used to contain the bursting charge as given for common shell.

For dimensions, capacity, &c., of the different patterns see table, p. 152.

**Issue.**

As given for common shell, p. 149.

\* Possibly there may be cases where it is desirable to burst these shells on graze, in bombarding a fortress the effect would be lost except where a shell struck some solid obstacle directly; in silencing guns it would probably be advantageous to burst shells when they graze.

† See Extracts, Vol. X., p. 199.

‡ See Extracts, Vol. X., p. 302.

§ For example, the diameter of a 9" shell has been reduced from 8·92" to 8·55" about the middle.

|| For alterations of form of the 11-inch common shell see Extracts, Vol. X., p. 185.

¶ The 9 seconds M.L. fuze might be used by the navy when firing 14 lb. charges.

The double shell is chiefly intended for use against wooden ships;\* owing to its great length,† it is inaccurate at long ranges, but at 2,000 yards it has given good results.

*Bags, Serge, bursting charge R.M.L. Common shell, Mark. I.*

The following table shows the dimensions of the bags :—

Use.  
§ 2493.

—	Width.	Length to Neck.	Neck.		
			Length.	Width.	
				Top.	Bottom.
	"	"	"	"	"
12" 35-ton .. .	12·25	32·5	6·5	4·25	2
12" 25-ton .. .	13	28·5	6·5	4·25	2
11" .. .. .	10	31·25	6·5	4·25	2
10" .. .. .	10·5	30	6·5	4·25	2
9" .. .. .	10	25·75	4·75	3·5	2
8" gun or Howitzer	8·5	23·5	4·75	3·5	2
7" " .. .	7·5	20·5	4·75	3·5	2
7" double .. .	10	26	4·75	3·5	2

In bales, same as cartridges, in the following numbers :—

Issue.

12", 11", and 10"	-	-	-	300
9", and 7" double	-	-	-	400
8" and 7"	-	-	-	500

\* Admiral Key, R.N., reports in a letter 22/2/66, on practice conducted against the "America" at 700 yards range; that "the destructive effect was unusually great, although in no instance did they set the ship on fire." . . . "One burst about six feet inboard on the lower deck, entirely destroying one half of a main deck beam with about eight feet square of planking, and cutting severely into the planks and a beam of the lower deck."

"Another struck the chain cable on starboard quarter by which the ship was slung, and burst before passing through, making a clean hole inside about 26" square, and laying eight planks on the side open to the extent of 28 feet by 8 feet; the damage in this case was very close to the water line." "These shells have been fired over 700 yards with astonishing accuracy." . . . "The real value of these shells has been more prominent in the late trials against the "America," where the effect of the large burster is so apparent." Vide Extracts, Vol. IV., p. 28.

† The Ordnance Select Committee report, "although these shell roll considerably, owing to their great length and low velocity, yet their accuracy is satisfactory up to more than 2,000 yards, a range at which they would probably never be used." Vide *Ordnance Select Committee Report*, 3858, 4/8/65.

## COMMON SHELL AND DOUBLE SHELL,

Calibre and Mark of Pattern.	Date of Approval.	§Changes in War Stores.	Length. ± $\frac{1}{10}$ in. per foot.	Diameters.		Thickness of Metal.			Weight empty.
				Body.	Studs.	Walls.		Base.	
						Top.	Bottom.		
12" 35 Ton, Mark I. -	7.1.73	2419	ins. 34.45	ins. ± .01 11.92	ins. ± .005 12.35	ins. 2.2	ins. 2.4	ins. 3.0	lbs. oz. 575 0
12" 35 Ton, Mark II. -	15.10.73	2557	34.45	11.92	12.35	2.2	2.4	3.0	575 0
12" 25 Ton, Mark I. -	20.3.69	1766 and 2356.	30.0	11.92	12.35	1.96	1.96	3.0	460 0
11" Mark I. -	3.9.72	2378	34.2	10.92	11.35	2.15	2.4	2.75	501 4
10" Mark I. -	18.9.68	1678, 1767, and 2356.	32.5	9.92	10.35	1.85	1.85	2.5	373 12
10" Mark II. -	28.5.73	2524	30.55	9.92	10.35	1.95	2.15	2.15	377 14
9" Mark I. - Afterwards altered to Mark II.	19.5.66	1239 and 2356.	26.6	8.92	9.31	1.5	1.5	2.25	232 0
9" Mark III. -	26.11.66	1337 and 2356.	26.6	8.92	9.31	1.5	1.5	2.25	232 0
9" Mark IV. -	21.10.67	1518 and 2356.	26.6	8.92	9.31	1.5	1.5	2.25	232 0
9" Mark V. -	9.12.68	1765 and 2356.	26.75	8.92	9.31	1.5	1.5	2.25	232 0
8" Mark I. -	15.10.66	1338 and 2356.	24.0	7.92	8.31	1.335	1.335	2.0	167 0
8" Mark II. -	21.10.67	1518 and 2356.	24.0	7.92	8.31	1.335	1.335	2.0	167 0
8" Mark III. -	9.12.68	1765 and 2356.	24.17	7.92	8.31	1.335	1.335	2.0	167 0
7" Mark I. -	18.1.66	1188 and 2356.	20.05	6.92	7.31	1.15	1.15	1.75	106 12
7" Mark II. -	19.5.66	1240 and 2356.	20.05	6.92	7.31	1.15	1.15	1.75	106 12
7" Mark III. -	24.10.66	1341 and 2356.	20.05	6.92	7.31	1.15	1.15	1.75	106 12
7" Mark IV. -	21.10.67	1518 and 2356.	20.1	6.92	7.31	1.15	1.15	1.75	106 12
7" Mark V. -	9.12.68	1765 and 2356.	20.4	6.92	7.31	1.15	1.15	1.75	106 12
7" Double, Mark I. -	9.10.66	1339 and 2356.	27.2	6.92	7.31	1.0	1.0	2.0	146 12
7" Double, Mark II. -	21.10.67	1518 and 2356.	27.2	6.92	7.31	1.0	1.0	2.0	146 12
7" Double, Mark III. -	9.12.68	1765 2356	27.2	6.92	7.31	1.0	1.0	2.0	146 12

N.B.—x indicates that the studs are formed to correspond to the curve of the groove instead of being indicates that they are of hard alloy, viz., 7 of copper to 1 of tin. Soft alloy, viz., 10 of copper to 1 of tin was subsequent to the above order.

On 20.12.72 it was ordered that all common shell for the Woolwich guns should be marked on the base with finished being marked on the stud as usual.

Unloading holes discontinued 27.1.73, § 2426, without a change of pattern.

## R.M.L. WOOLWICH GUNS.

Approximate bursting Charge, Shell Powder L.G.	Weight of filled Shell. Limits of Error $\pm 1\frac{1}{2}$ per cent.	Studs screwed in or swedged into Under-out Holes.	Distance between centres of Front and Rear Stud.	Edge of Bottom rounded.	Marks in Front of One Front Stud.	Marks on Rear Stud for the same Groove as the marked Front Stud. The date refers to the manufacture of each individual shell.	REMARKS.
lbs. oz.	lbs. oz.		ins.				
40 0	615 0	Swedged	7	Yes	R I L ↑	Date and × ("35 ton" on every alternate stud.)	2 rings of studs.
40 0	615 0	Swedged	7	Yes	R II L ↑	Date and × ("35 ton" on every alternate stud.)	3 rings of studs.
36 10	496 10	Swedged	7	Yes	R I L ↑	Date and ×	
28 12	530 0	Swedged	8	Yes	R I L ↑	Date and ×	
27 6	401 2	Swedged	8	Yes	R I L ↑	Date and ×	
20 12	398 10	Swedged	8	Yes	R II L ↑	Date and ×	Thicker walls and bottom.
20 0	252 0	Screwed	8	No	R II L ↑	Nil	- Groove round head for O.P. extractor countersink '1".
20 0	252 0	Screwed	8	No	R III L ↑	Nil	- Two extractor holes for N.P. extractor.
20 0	252 0	Swedged	6	No	R IV L ↑	Date and ×	Studs swedged in and placed at a constant distance apart.
20 0	252 0	Swedged	6	Yes	R V L ↑	Date and ×	Rounded base, unloading hole.
14 9	181 9	Screwed	7	No	R I L ↑	Nil	
14 9	181 9	Swedged	5	No	R II L ↑	Date and ×	Studs swedged in and placed at a constant distance apart.
14 9	181 9	Swedged	5	Yes	R III L ↑	Date and ×	Rounded base, unloading hole.
9 4	116 0	Screwed	9	No	R I L ↑	Nil	- Three extractor holes, studs of copper 9 lbs., tin 1 lb., zinc 1 oz. This shell has the Moorsom bush, and requires a G.S. adapter.
9 4	116 0	Screwed	9	No	R II L ↑	Nil	- Three extractor holes, countersink '1", and G.S. bush.
9 4	116 0	Screwed	9	No	R III L ↑	Nil	- Two extractor holes and countersink '2".
9 4	116 0	Swedged	4.6	No	R IV L ↑	Date and ×	Studs swedged in and placed at constant distance of 4.6".
9 4	116 0	Swedged	4.6	Yes	R V L ↑	Date and ×	Rounded base, and unloading hole.
13 3	159 15	Screwed	12.0	No	R L ↑		
13 3	159 15	Swedged	4.6	No	R II L ↑	Date and ×	Studs swedged in and placed at constant distance of 4.6".
13 3	159 15	Swedged	4.6	Yes	R III L ↑	Date and ×	Rounded base, and unloading hole.

concentric with the projectiles as in previous patterns, and in all but 7" projectiles previous to 8372. It also approved for all natures on the above date. Soft studs are indicated by the date marked on them being the day and month of casting and calibre, the 12" being followed with "25 ton" or "35 ton," the date when



## 3. Shrapnel shell.

3. *Shrapnel Shell*.—Calibres: 12-inch, 35-ton; 12-inch, 25-ton; 10-inch, 9-inch, 8-inch, and 7-inch.\* Gauge, G.S. Fuze, 9 seconds M.L. Mark I. (Should these shells be again included in L.S. equipment the 9 seconds M.L. Mark III. fuze would be used.) For dimensions, &c., see table, p. 156.

These shells have been withdrawn from the L.S. equipment. The Woolwich guns, as before stated, are only mounted on sea fronts; † it is considered preferable to trust to common shell and Palliser projectiles for use against ships. They are still, however, issued to the navy, and would be available for L.S. if specially required.

Some of the early patterns gave indications of weakness, the 10-inch occasionally broke up, ‡ so it was considered desirable to make them all stronger; this was done by increasing the thickness of the walls, the number of sand shot were diminished, and the bursting charge was increased.

## Construction.

The construction generally resembles that of the B.L. Shrapnel given on page 117, but differs in several details. § See plate, p. 334.

The body of the shell is nearly as thick as that of the common shell, which it resembles in studding and external dimensions.

The walls of the shell increase slightly in thickness from the top to the base, || and are weakened by six grooves or "lines of least resistance."

At the base the shell contracts, forming a chamber for the powder; a slightly recessed groove runs round the top of the shell near the exterior circumference to receive the Bessemer metal head.

A tin cup, coned at the top to facilitate unloading, fits the powder chamber; above this is a wrought iron disc, also coned to suit the cup, and screwed to receive a wrought iron pipe lacquered internally, which occupies the centre of the shell. The fuze socket fits into the upper portion of this pipe; the diameter of the pipe is much larger than in the first patterns to facilitate loading and unloading.

The sides of the shell are lined with brown paper to prevent the rosin adhering too firmly to the iron.

The interior of the shell is filled with sand-shot ¶ secured in their place by rosin (which is poured in hot). Above the balls is placed a disc of felt or kamptulicon saturated with kit composition.

The head is made of Bessemer metal, struck with a radius of one diameter and lined with wood, having a gun-metal socket soldered into the head, which serves to take the fuze. The Bessemer metal is bent down, as shown in the cut, so as to form a shoulder for the socket, which is made flush with the head of the shell (the projecting socket in former patterns being liable to be injured in travelling).

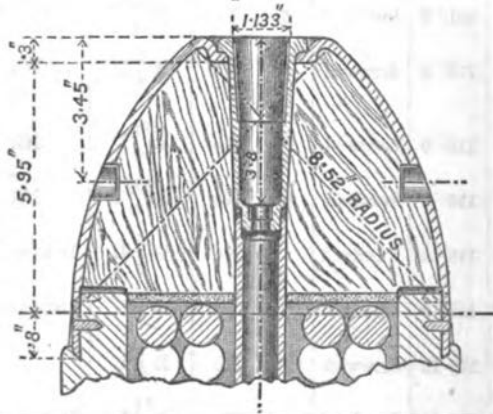

§ 2491.

\* The 11-inch gun, being exclusively for L.S., has no Shrapnel shell.

† It is thought that a boat attack could be repelled by case shot, which acts up to about 600 yards, while against ships the other shells would be more effective.

‡ See Extracts, Vol. ix., p. 127, 10-inch shell were fired with bursting charge and plugged, and broke up in the gun.

§ The construction given is that of the latest pattern.

|| The increase varies from .2 inch in the larger calibres to .1 inch in the smaller.

¶ Iron balls are used simply from economy; lead and antimony balls have been proved to be more effective.

The socket is tapped at the base to receive the primer, *see* p. 99, and at the top to receive the G.S. plug.

The head is secured to the body by means of rivets and twisting-pins; the latter are only intended to prevent the head from twisting off in flight, and the holes in which they are inserted are close to the top of the cast iron rim, so as to offer no resistance in a longitudinal direction when the head is blown off by the action of the bursting charge. A band of solder prevents the pins and rivets from dropping out.

Holes are bored through the head to take small tin sockets, which are fitted into the wooden lining and serve as extractor holes.

Filled for S.S., with primer inserted and boxed; one per box.

If required for L.S. they would be issued, empty, loose.

Issue.  
§§ 2357, 2406,  
2480.

Would be available against troops, and, owing to the great distance to which the shell keeps up its velocity, would probably be useful up to about 3,200 yards; beyond this distance the 9 seconds fuze would not act. The shell gives a good cone of dispersion if burst within 300 yards of the object; but should the troops be in close order it ought to be burst much nearer, and would be probably more effective if burst about 100 yards from the object.\*

Use.

---

\* Extracts from proceedings of Ordnance Select Committee. Report of Armstrong and Whitworth Committee. Report of a Select Committee on Ordnance, House of Commons, 1862, &c. &c. relative to the merits of segment as compared with Shrapnel for field guns, published in a Blue Book in 1869, gives the results of the trials of a large number of heavy Shrapnel shell. On page xix. it is stated with regard to the trial of 9-inch and 7-inch M.L., 7" B.L., and 64-pr. R.M.L. Shrapnel that "The results of this practice are most satisfactory and afford conclusive evidence of the formidable nature of Shrapnel shell. It is apparently most effective when burst within 100 yards of the target, and at about 10 feet above the plane, but its efficiency in the larger natures is still retained, even when the burst takes place at so great a distance as 300 yards short of the object, a condition which the Committee believe would not be realised by projectiles constructed on the segment principle.

"The pattern Shrapnel shell for 7-inch, 8-inch, and 9-inch M.L. guns which have been provisionally approved to meet urgent supplies for land service, are composed of balls of mixed metal, viz., lead and antimony, and such was the construction of the Shrapnel tried by the Committee in February last. They have, however, since tried, at Colonel Boxer's request, some Shrapnel made up with iron balls. Although inferior in general effect to the shell with balls of mixed metal, they appear to be still efficient, but it should be observed that the total weight of these projectiles was in each case below that of the service projectile, and that in consequence of the substitution of iron for lead the number of balls in each shell was materially diminished."

On page xxiii. will be found some remarkably good practice. The shell were fired against three rows of targets, 20 yards apart, each row having a front of 9 ft. by 54 ft. The shells were not of the present pattern, but the following result is worth quoting as showing the possible effect of a Shrapnel shell fired under favourable conditions. A 9-inch Shrapnel shell, weight 255 lbs., having 374 3 oz. balls and a bursting charge of 12 oz., was burst 136 yards short of the first target and 15.5 feet above the plane, the range to the first target being 1,200 yards. The total hits out of six rounds were 3,199, and of that number 3,038 went through the targets, the average number of hits per round being 533. This shows that many of the shot must have penetrated two targets, as the number of hits is considerably greater than the number of balls in the shell. By looking through the practice the enormous results obtained by a few rounds of Shrapnel shell, properly directed, will be seen. No doubt when the Woolwich guns are mounted on land fronts such shells will again become desirable for them.

Trials of 10" Shrapnel containing 4 oz. and 3½ oz. balls will be found in Extracts, Vol. xi., p. 156. A shell containing 376, 3½ oz. sand shot gave 646 hits on 3 rows of targets at a range of 1,050 yards; at 2,050 yards it gave 312 hits.

SHRAPNEL SHELL, R.M.L. WOOLWICH GUNS.

Calibre and Mark of Pattern.	Date of Approval.	§ Changes in War Stores.	Length. ± 1/16 in. per foot.	Diameters.		Thickness of Metal.			Number and Nature of Balls contained.	Weight of Shell, empty.	Weighed bursting Charge, Pistol, or R.G. Powder.	Distance between Centres of front and rear Stud.	Bottom flat, or rounded at Edge with a radius of	Remarks.				
				Body.	Studs.	Top.	Bottom.	Base.							lbs. oz. ± 1.5 per cent	lbs. oz.	ins.	ins.
12", 35 ton, Mark I.	25/7/73	2522	33.55	11.92	12.35	2.2	2.4	2.25	368, 4 oz., or 453, 3/4 oz. sand shot.	615 8	1 15	7	3.96					
12", 25 ton, Mark I.	17/2/70	1873	30.75	11.92	12.35	—	—	—	580, 4 oz. sand shot	495 0	1 2	7	3.96					
12", 25 ton, Mark II.	31/10/72	2381	29.75	11.92	12.35	2.04	2.24	2.25	276, 4 oz. sand shot	495 0	1 15	7	3.96	Thicker sides, gun metal socket, larger centre tube, thicker diaphragm, and diaphragm and tin cup coned.				
12", 25 ton, Mark III.	11/7/73	2523	29.05	11.92	12.35	2.04	2.24	2.25	276, 4 oz., or 389, 3/4 oz. sand shot.	495 0	1 15	7	3.96	Flush socket.				
10" Mark II.*	28/3/72	2366	31.88	9.92	10.35	1.59	1.81	1.88	306, 4 oz. sand shot	403 0	1 9	8	3.96	Same improvements as 12", 25 ton II.				
10" Mark III.	11/7/73	2523	31.13	9.92	10.35	1.59	1.84	1.88	306, 4 oz., or 376, 3/4 oz. sand shot.	403 0	1 9	8	3.96	Do. do. III.				
9" Mark I.†	21/3/68	1609	26.25	8.92	9.31	—	—	—	564, 2 oz. sand shot	250 0	0 12	6	3	Do. do. II.				
9" Mark II.	28/3/72	2360	26.25	8.92	9.31	1.34	1.52	1.7	374, 2 oz. sand shot	254 0	1 5	6	3	Do. do. III.				
9" Mark III.	11/7/73	2491	25.35	8.92	9.31	1.34	1.52	1.7	374, 2 oz. sand shot	254 0	1 5	6	3	Do. do. III.				
8" Mark I.†	21/3/68	1609	23.25	7.92	8.31	—	—	—	376, 2 oz. sand shot	174 0	0 10	5	2.65	Do. do. II.				
8" Mark II.	28/3/72	2366	23.23	7.92	8.31	1.11	1.27	1.5	300, 2 oz. sand shot	180 0	1 0	5	2.65	Do. do. III.				
8" Mark III.	11/7/73	2491	22.55	7.92	8.31	1.11	1.27	1.5	300, 2 oz. sand shot	179 0	1 0	5	2.65	Do. do. III.				
7" Mark II.‡	21/3/68	1609	19.72	6.92	7.31	—	—	—	227, 2 oz. sand shot	112 0	0 8	4.6	2.0	Do. do. II.				
7" Mark III.	28/3/72	2366	19.72	6.92	7.31	.9	1.04	1.25	192, 2 oz. sand shot	117 4	0 12	4.6	1.0	Do. do. III.				
7" Mark IV.	11/7/73	2491	19.0	6.92	7.31	.9	1.04	1.25	192, 2 oz. sand shot	115 10	0 13	4.6	1.0	Do. do. III.				

\* 10" Mark I., described in § 1806, declared obsolete § 2420.

† The pattern of 9" and 8" approved provisionally §§ 1888, 1889 never having governed any supplies for service were withdrawn and those approved in § 1609 substituted as Mark I.

‡ 7" Mark I. § 1890, with cast-iron diaphragm and no tin cup, is declared unserviceable and is broken up on return to Woolwich.

N.B.—The marks on the rear stud, and the marks in front of one front stud of Shrapnel are the same, and have the same signification as those in the common shell table, p. 159. The date of casting, &c. will also be found on the base of Shrapnel as in common shells.

§ R.F.G. powder may be used for the bursting charge.

## PALLISER PROJECTILES.

It seems desirable before giving a description of the chilled projectiles now in the service, to enter on such an explanation of their character as will show the reasons for the qualities which they possess, but it does not seem necessary to give any lengthened account of their introduction, probably the following will suffice for most readers,—

\*In 1863, Major Palliser proposed a projectile of iron cast in a metal chill to render it hard for the penetration of armour, providing for the evil effects of brittleness by the form of head he gave to it which was an "elongated point."

These projectiles, as fired in 1864, were chilled to a considerable depth, but not throughout; † they proved so successful that their manufacture was afterwards carried on in the Royal Laboratory, until Mr. Davidson, the manager of that department, so worked out the selection and trial of various samples of iron, and the method of conducting the manufacture in concert with Major Palliser, as to bring the projectiles to the state of efficiency in which they now exist in the service.

In those last manufactured the heads are cast in metal and the bodies in sand, the samples of iron being such that the heads are chilled white nearly to the centre, the bodies being an even mottle throughout.

In degree the powers of these projectiles excel those of the original Palliser shot, but the principle advocated by the inventor remains, viz., that a hard iron, chilled white, is used to punch, its deficiency in tenacity being met by the form of head employed, which belongs to one of the classes proposed by Major Palliser in the first instance.

To explain the nature of the iron employed, it is necessary to bring together a few well-known facts.

Molten iron (*i.e.* wrought iron) is hardly to be obtained under any circumstances, the Bessemer process being almost the only method of producing it. Dr. Percy in his work on iron and steel ‡ mentions his having at first doubted that it was actually obtained in that process. Effect of chilling on the metal.

Iron can, however, be readily melted in contact with carbon, but the result is no longer pure metallic iron, the metal having only fused as it became partly or entirely combined with carbon in some form of carbide, the exact proportions of which have never been satisfactorily determined (we may call it  $Fe_x C_y$ ).

As this molten product cools under ordinary circumstances, the tendency of the carbon and iron is to separate more or less, should actual separation take place to any great extent the iron will become grey, showing crystals of metal and black masses of carbon, termed graphite ( $Fe + C$ ); in some cases the separate particles are larger than others, thus gray hot blast has a coarser texture than grey cold blast iron.

Grey iron is in all cases soft and easily fused.

There is a curious indication of the kind of metal even in the molten mass, grey being known by a small breaking or cracking running rapidly

\* For a more full account, *vide* a paper written by Captain V. D. Majendie.—*Proceedings of Royal Artillery Institution*, Vol. v., part 7, January 1867.

† Captain Browne states:—I picked up fragments myself to investigate the truth of some remarks of Dr. Percy, and tested them in a rough way for the chemical condition of the carbon and the iron, which went to prove the above, viz., that the interior was in a very different state from the exterior.

‡ Percy's *Metallurgy*, "Iron and Steel," p. 815.

in the film, which forms on the surface, the form being sometimes zigzag in cold blast grey, or small stars or spider shaped cracks, as in hot blast grey.

On the other hand should very little or no separation of carbon and iron occur, white iron will be the result, which is very hard and brittle, and difficult of fusion, giving a silvery fracture, and which is recognised in the molten state by the film breaking across in coarse broad cracks less continuously than the grey iron.

Without stating dogmatically what is the exact action of a blast furnace, which is liable to vary with circumstances, and is diffidently discussed even by metallurgists or manufacturers, it may be generally said, in spite of the fact that some samples of iron will be white and others grey, however they may be cooled, that any tendency of iron and carbon to separate is encouraged by slow cooling, and thus some irons which would be mottled if slowly cooled, may solidify into a kind of white iron if chilled or quickly cooled. This Major Palliser effected by the use of metal moulds, which chill in virtue of their conducting power.

To illustrate the action of metal as a conductor of heat, it is only necessary to remember that metal out of doors ordinarily feels colder to the touch than wood, cloth, or any less good conductor, the actual temperature is the same, but to the warm human body the metal feels colder, because it carries away warmth from the human body rapidly. In a Turkish bath, on the other hand, both metal and wood are hotter than the human body, and therefore the iron which conducts its excess of heat rapidly into the human body scorches it much more than the non-conducting wood or rug.

The effect therefore of a larger mass of metal such as a chill on molten iron, may at once be seen to be very great as compared with the comparatively non-conducting sand used in ordinary moulds, nor is this question greatly affected by the metal being warmed up to 80 or 100 degrees temperature, which is nothing compared to the heat of molten iron, in fact, metal is a rather better conductor when warm than when quite cold, and so chills rather more efficiently and immediately.

The iron thus rendered white possesses generally the qualities of white iron, that is, intense hardness and crushing strength and considerable brittleness, but it is probably rather denser,\* and appears much finer and more silky in its fracture.

Now this being the opposite extreme to annealing, which renders metal uniform and even throughout its mass, it is not surprising that its particles should be in an unnatural and constrained condition, and that on slight provocation such molecular action should take place as would cause the projectile to split, and this has actually occurred under certain circumstances (*vide* pages 160, 166), and the chilling effect in manufacture is carefully carried out with a view to meet this in ways which need not here be noticed.

The Palliser projectiles then possess the following properties in an eminent degree:—

1. Intense hardness.
2. Crushing strength.
3. Brittleness or want of tenacity.
4. Increased density.

---

\* Captain Browne states:—Some very limited experiments I made with the assistance of the chemical department as to this, gave an increase of density to mottled metal on casting in chills of about  $3\frac{1}{2}$  per cent., and large as this is, I have reason to think it is likely to be correct.



Hardness prevents the point from flattening in penetration, so that while the points even of steel shot are commonly found flattened after impact, those of chilled shot, however broken, retain their sharp form.

Crushing strength may appear at first to be very much the same as hardness, but while the latter relates to the rigidity of actual particles, the former applies to the rigid connection or building up of particles so as to resist their being forced in upon each other.

To compare glass and iron, the former has greater hardness, and the latter crushing strength, thus the former will scratch the latter but the latter will crush the former.

It seems probable that crushing strength is a very important element in Palliser projectiles, and it may be observed that in punching ordinary sheet iron with a steel punch, when sufficient force is applied, either the punch must crush or the part it presses must be torn out and separated from the rest of the sheet, thus the two opposing forces are the crushing strength of the punch and the tensile strength of the sheet iron.

It seems probable that this reasoning may hold good to some extent in the question of piercing armour plates, although it must not be applied without reserve to such a sudden performance of work as must here take place.

The form of head of Palliser projectiles is admirably suited to enable such metal to do its work in penetration when its surface is being pressed from front and sides towards one centre.

The fact that it actually resists crushing seems to be established by the circumstance that the fragments which are picked up are *remarkably cool* as compared with pieces of plate or of ordinary cast iron shot, for it is well known that material crushed or compressed becomes hot in the operation.

As to brittleness, it can hardly affect the front portion of the shot, pressed in as noticed above towards its centre; it is hard to say how much of its momentum the rear portion lends to the blow before it shivers away from it, but it is obvious that it is better here to have the iron in its rather less brittle, that is, its mottled condition.

Next, as to the form and distribution of metal in the projectile, the ogival of  $1\frac{1}{2}$  radius (*vide p. 145*) has been considered the best shape of head for shells.

Major Palliser has very naturally tried to get the metal forward as far as possible, so as to impress its momentum on the plate without acting through the medium of the sides or walls of the shell which must be made thicker as the base of the shell becomes heavier; and thus diminish the interior capacity and consequently the bursting charge.

Some premature explosions of these shells in the bores of guns have been attributed to the base being made so light as not to support the bush of the filling hole under the pressure of the firing charge of the guns, and hence a slight increase in metal was made in more recent patterns.

It will be seen that the shells at first made for certain calibres (9" and 8") had thicker walls and less capacity for powder than those since manufactured, the momentum of both shell being equal, the thinner shell being slightly increased in length to make it up in weight; \* the § 1518.

\* It must not be assumed from the wording of the paragraph in Changes in War stores referred to, that all Mark I. shells were of small capacity, for this is by no means the case.

relative advantages are increased explosive force in favour of the large capacity shells, and resistance to crushing in favour of those of small capacity, the former have been adopted, Palliser shot being associated with them.

As has been noticed above the projectiles (both shell and shot) manufactured in the Royal Laboratory, since March 1870, have been cast in moulds of sand with metal ends for the heads, hence the head is regularly chilled and the body is evenly mottled iron; by this method the head has the full crushing strength while the body has more tenacity, and as has been said probably impresses rather more of its force on the target on impact, before it splits away from the head, but the main advantage in casting the bodies in sand is that the metal is believed to be far less subject to the action of the molecular forces which, as noticed above, may either split it in store or crack it so as to cause rupture in the bore of the gun. The studs, both of Palliser shell and shot have in all cases been attached by swedging into undercut holes in the projectiles.

### PALLISER SHELL.

#### *General Description.*

Calibres, 12", 35 ton, 12", 25 ton, 11", 10", 9", 8", and 7". The form in every case is cylindro-conoidal, the head being ogival struck with a radius of  $1\frac{1}{2}$  diameters. See plate, p. 335.

The total length varies between a little over 2 calibres and a little over  $2\frac{1}{2}$  calibres, as may be seen in the table, p. 165.

The bottom is flat, in the more recent patterns it is rounded at the edge to facilitate loading.

In the centre of the bottom is a filling hole bushed with wrought iron, and closed with a gun metal screw plug which should fit tightly and evenly, and is therefore selected for each shell, and is not intended to be interchanged with that of another.

The wrought-iron bush is cast into the shell, being placed for this purpose on the core spindle; it has grooves running round the exterior to cause the metal to enter and hold well in round it, and for more secure closing of the joint the top flange is removed in the form of an annular groove in the shell's base, undercut towards the filling hole, and of such a width as to bring the junction of wrought and cast iron along the middle of the groove, into which is hammered a ring of lead, *vide* plate, p. 335.

The mottled iron employed in casting Palliser shell is too hard to admit of tool work even when the metal is cast in sand, hence the necessity for introducing the wrought iron ring in the base to allow a screw thread being tapped in it to receive the gun-metal plug. The holes for the studs and extractor holes are cast in the projectile. The shell are brought as nearly as possible to their final dimensions in casting, and ground down to their proper size by revolving grind-stones.\*

All Palliser shell are lacquered internally with red lacquer.† The

---

\* Formerly the bodies were cast slightly smaller, having bands at the shoulder and base; these bands were ground down to the final dimensions.

† Black lacquer was tried in 1870, but did not answer.

bursting charge is further protected by a bag; the dimensions of the bags will be found on p. 163.\*

One point has escaped without such definite marks as could be wished, and this must be specially noticed, viz., the difference between 9-inch and 8-inch shells of large and small capacity. By reference to the table, p. 165, it will be seen that all the patterns except I. are of large capacity, containing bursting charges of 5 lbs. 14 ozs. and 4 lbs. 6 ozs. respectively, all shells then of II. and subsequent patterns are of large capacity.

The Table gives Mark I., shells of small capacity, viz., the 9-inch to contain 2 lbs. 13 ozs. and the 8-inch 2 lbs. of powder, but unfortunately shells of large capacity were manufactured without changing the numeral, and therefore a Mark I. shell may be either a small capacity shell, as given in the Table, or it may be one of a large capacity, and the only method of identifying them, without testing their capacity, is a careful measurement of the length, those of large capacity being the same length as Mark II. shell given in the Table, but in numeral and other external marks resembling Mark I.

Palliser projectiles are tested by water pressure of 100 lbs. on the square inch, and by hammering the base all over with a pointed hammer, to detect any weak or porous portion. Shell so examined used to be marked E. on a rear stud, but as this examination is now invariably carried out in manufacture it has not been thought necessary to continue marking them. Shell made between 1870 and August 1872 will be found to have E. on the stud, as well as any examined at out stations, *see* p. 162, but shells made subsequent to August 1872, although examined, will not be marked with E.†

Palliser shells were formerly painted black with a white ring and a red tip, but are now painted black with a white tip, the studs being in all cases left unpainted as with other projectiles.

For marks, *see* table, p. 165. All shells made since 1873 inclusive have the word "shell" cast on the base and also the calibre. Where there are two guns of the same calibre the weight of the gun is given.

Loose:—

1. Filled for S.S. wrench hole in base plug filled with red lead to enable a filled shell to be distinguished by touch.
2. Empty for L.S.

#### *Use and Experience.*

As has been noticed above, these shells are intended for use against armour-clad vessels, it is very uncertain if they would explode if fired against iron vessels not armour-plated, and they would probably altogether fail to burst against wooden ships.‡

The discovery of porous places under the surface of the bases of Palliser projectiles in the spring of 1870 led to a searching examination

---

\* The use of bags was recommended in 1870. The trial of various kinds of bags and the comparative cost of bags and lacquering will be found in *Extracts*, Vol. VIII., p. 145. The question of discontinuing the lacquer was raised, but it was decided to continue it. *Extracts*, Vol. VIII., p. 227.

† The base of an examined shell shows the marks of the sharp pointed hammer.

‡ Lieut. Boxer, R.N., advocated the employment of a percussion fuze in the base of a Palliser shell to ensure the explosion in the event of a mistake as to the character of an adversary.

of those projectiles in store at Woolwich, and this defect was found to exist to a sufficient extent to render it expedient to extend the examination to certain out-stations, the cavities being detected by searching by slight blows with a pointed hammer; any flaws so discovered should be probed with a sharp wire, where the metal seems crumbling or globular in appearance, it will generally come away, and perhaps be followed by dust-like particles till a sound bottom is reached, a cavity of about the diameter and one-fourth the depth of an ordinary thimble may exist near the circumference of a shell or shot bottom without in the least weakening it, but it is ordered (in the instructions for examination) that all shells which may appear "doubtful" are to be returned to Woolwich with those which appear "unserviceable."\*

The tip or point of a chilled projectile is occasionally broken off by the impact of a shell or shot rolled or struck obliquely against it; for, strange as it may appear, the point which may penetrate directly through many inches of armour without injury may be fractured by a very slight transverse blow.

A shell with the entire point gone, even to the extent of  $\frac{1}{8}$ th inch, would not be re-issued from Woolwich for service, but would be issued for practice only, painted with a yellow band, unless the fracture was so considerable as to render the shell very unsightly. At out-stations shell damaged in this way can be utilized for practice.

12-inch 25 ton and 10-inch Palliser shells, Mark I., were found not to be satisfactory; they are broken up on return to Woolwich.†

The service lacquer which holds very well to other projectiles is apt to chip away from the interior of Palliser shell; this arises from the fact that the projectile is not re-heated for lacquering, but undergoes this operation in the stage of cooling most nearly approaching to the proper temperature, hence an exact degree of heat is not to be attained, and consequently the lacquer does not always hold well to the metal.

At the same time, another possible cause of premature explosion in Palliser shell was discovered in the presence in these shells of particles cut from the wrought-iron bush in the operation of tapping, and either from the warmth generated in the operation, adhering to the lacquer or remaining in the curve of the interior of the shell so as to escape removal. In consequence of this it has been ordered that any powder removed from Palliser shell is to be treated as unserviceable, and "at once thoroughly wetted and destroyed." Under these circumstances it has been decided to introduce serge bags to contain the bursting charge as an additional precaution against premature explosion; these bags are made bottle-shaped, and are introduced through the filling hole. All Palliser shells are completely filled with "shell powder L.G." See page 52.

§ 1922, also  
Appendix, p.  
277.

---

\* On carrying out the examination a considerable number of Palliser shells were found unserviceable. Extracts, Vol. VIII., pp. 222, 224, 225.

† Only 152 12-inch and 708 10-inch, Mark I., were made. Extracts, Vol. VIII., p. 65.

*Bags, Serge, Bursting Charge, Palliser Shell.*

The following table shows the dimensions of the bags :—

Calibre, Charge, Mark.	§ Changes in War Stores.	Greatest width.	Length to neck.	Neck.		REMARKS.
				Length of neck.	Width of neck.	
12", 35 ton, 9 lbs., I. - -	2459	ins. 9'0	ins. 19'6	ins. 5'0	2'7	
12", 25 ton, 14 lbs., I. - -	1970	10'1	23'0	4'1	2'7	
11", 9 lbs. 4 oz., I. - -	2372	8'4	20'0	5'0	2'7	For 11" shell, Mark I., of which, though not approved, some issues were made. § 2429.
11", 6 lbs. 7 oz., II. - -	2422	8'4	16'0	5'0	2'7	
10", 6 lbs. 14 oz., I. - -	1970	7'2	19'5	4'0	2'7	
9", 5 lbs. 8 oz., I. - -	"	7'7	15'6	3'6	2'7	
9", 2 lbs. 13 oz., I. - -	"	6'1	12'6	3'6	2'7	Small capacity shell.
8", 4 lbs. 8 oz., I. - -	"	6'9	15'0	3'4	2'7	
8", 2 lbs., I. - -	"	5'3	12'0	3'0	2'7	Do.
7", 2 lbs. 8 oz., I. - -	"	6'0	12'0	3'2	2'7	

Loose, in paper parcels, according to demand.

Issue.

Different reasons have been assigned as to the cause of the explosion of the bursting charge in Palliser shells.\* It is not due to the shell breaking up, as the same action takes place in Whitworth's hardened steel shell, which do not break up. The metal of the shell does not acquire a sufficiently high temperature on striking, so the explosion is not due to heat transmitted from the shell; the most probable cause appears to be the violent concussion of the powder on striking.

On firing, the powder sets back, forming a dense compact mass so hard that sometimes it cannot be cut by a copper tool; on the shell striking the plate, this hard mass of powder would be dashed forward and pressed into the contracted part of the shell, thus undergoing great friction, probably sufficient to tear the bag and thus cause the powder to explode.

The setting back of the powder on firing is necessarily much less violent from the cushioning action of the loose grains of powder.†

The hardness of the metal employed in Palliser projectiles has already been noticed, and it may be remarked that even in the body of the projectile it is necessary to have a hard unyielding metal. Even if it was possible to employ a softer and more tenacious metal in combination with a hard head, there would be loss of power.

\* See Captain W. H. Noble, R.A., on Ballistics, p. 93.

† Occasionally, to prevent the explosion taking place before the shell has penetrated sufficiently, two bags have been used in experimental practice.

Palliser projectiles which have been fired and recovered will not be fired again, § 1648. but will be returned into store to be condemned and re-cast, as they are liable to break up in the bore when fired a second time.



Projectiles on striking iron plates are more or less heated, any force converted into heat must be lost so far as useful effect goes. If the amount of heat generated could be exactly ascertained, the loss of force could be calculated by making use of the mechanical equivalent of heat. Sir W. Armstrong carefully measured the amount of heat generated by concussion in the following metals, and obtained an approximate estimate of the amount of work lost by conversion into heat.

With hard tempered steel shot the force expended in heating the projectile was about  $\frac{1}{10}$  of the power stored up on striking; with softer steel the loss was about  $\frac{2}{10}$ , and with wrought iron the loss was more than half. Cast iron has hitherto eluded observation on account of the difficulty of collecting the fragments and measuring the amount of heat in them.

The penetration of Palliser projectiles has increased considerably since their first introduction, owing to improvements in the manufacture of the shell and in the powder. The old rule which used to be given was to add an inch to the calibre of the projectile for its penetration into iron plates at short ranges. Supposing the projectile to be fired with a battering charge at a range of 200 yards, the penetration will be found approximately by adding 2 inches to the calibre. This rule must not, however, be applied to guns which are specially powerful for their calibre; the 11-inch gun will penetrate about 14 inches, while the 12-inch 35-ton gun has penetrated 17 inches of iron, backed by 12 inches of teak and an iron skin  $1\frac{1}{4}$  inches thick.\*

The following formula, due to Captain A. Noble, of Elswick, is said to give very good approximate results,—

$$R = 3.138 T^{\frac{1}{2}},$$

where  $R$  = energy in foot tons per inch of shot's circumference necessary to penetrate a plate of  $T$  thickness.†

For the dimensions, capacity, &c., of the different patterns of Palliser shell, *see* p. 165.

\* Extracts, Vol. X., p. 174.

† This rule may be applied to iron plates varying from 4" to 15" in thickness.

Calibre and Mark of Pattern.	Date of Approval.	§ Charges in War Store.	Length in Inches ± 1/16 in. per foot.	Diameters.		Thickness of Metal.		Weight empty.	Approximate bursting charge, lbs. G.	Weight of filled shell, lbs. oz. ± 1.5 per cent.	Studs, hard or soft.	Distance between Centers of front and rear Studs.	Edges of Bottom rounded.	Bands round Shoulder and Base.	Bodies cast in Sand.	Marks on a rear Stud, the Date referring to the Manufacture of Shell.	Remarks.
				Body.*	Studs.	Walls.	Base.										
12" 35-ton, I.	10/10/72 Provly.	2380 2450	31.3	ins. ±.01 11.925 ±.015	ins. 12.35	ins. 3.25	ins. ±.06	lbs. oz. 691 2	lbs. oz. 9 14	lbs. oz. 701 0	Soft	7	Yes	No	Yes	Date x, and I. - "35-ton", on every alternate stud. Date, x, and II. - "35-ton", on every alternate stud.	2 rings of studs. 3 rings of studs.
12" 25-ton, I.†	11/11/68	1707	29.2	ins. 11.92	ins. 12.35	ins. 2.785	ins. 2.5	lbs. oz. 585 0	lbs. oz. 9 14	lbs. oz. 609 14	Hard	7	Yes	No	Yes	Date, x, and II. -	11", Mark I., was not finally approved, a number issued, capacity 9 lb., 4 oz. By § 2429 it was decided that only one description of Palliser projectile should be issued for the 11" gun, viz., that described in § 2106 as Shot, Palliser, 11", Mark I., which was then ordered to be called Shell, Palliser, 11", Mark II.
12" 25-ton, II.	7/3/70	1872	29.3	ins. 11.92	ins. 12.35	ins. 2.85	ins. 2.85	lbs. oz. 580 0	lbs. oz. 14 0	lbs. oz. 600 0	Hard	7	Yes	No	Yes	Date, x, and II. -	
11", Mark II.	18/11/72 28.1.73	2106 2429	28.3	ins. 10.925 ±.015	ins. 11.35	ins. 2.9	ins. 3.0	lbs. oz. 530 0	lbs. oz. 6 7	lbs. oz. 530 7	Soft	8	Yes	No	Yes	Date, x, and II. -	Small capacity shell.
10", Mark I.†	18/9/68	1678	26.8	ins. 9.92	ins. 10.35	ins. 2.5	ins. 1.94	lbs. oz. 301 0	lbs. oz. 9 0	lbs. oz. 400 0	Hard	8	Yes	Yes	No	Date and x.	
10", Mark II.	7/3/70	1872	26.3	ins. 9.92	ins. 10.35	ins. 2.8	ins. 2.5	lbs. oz. 303 2	lbs. oz. 6 14	lbs. oz. 400 0	Hard	8	Yes	No	Yes	Date, x, and II. -	Small capacity shell.
9", Mark I.†	14/1/67 Provly.	1386	20.2	ins. 8.92 ±.015	ins. 9.31	ins. 2.71	ins. 2.1	lbs. oz. 247 3	lbs. oz. 2 13	lbs. oz. 250 0	Soft	8.7	No	No	No	Nil	
9", Mark II.	-	Nil	21.5	ins. 8.92	ins. 9.31	ins. -	ins. -	lbs. oz. 244 2	lbs. oz. 5 14	lbs. oz. 250 0	Hard	0	No	Yes	No	Date and x.	
9", Mark III.	9/12/68	1765	21.46	ins. 8.92	ins. 9.31	ins. -	ins. -	lbs. oz. 244 2	lbs. oz. 5 14	lbs. oz. 250 0	Hard	6	Yes	Yes	No	Date and x.	Small capacity shell.
9", Mark IV.	7/3/70	1872	21.46	ins. 8.92	ins. 9.31	ins. 2.15	ins. 2.0	lbs. oz. 244 8	lbs. oz. 5 8	lbs. oz. 250 0	Hard	6	Yes	No	Yes	Date, x, and IV. -	
8", Mark I.†	14/7/67 Provly.	1887	18.4	ins. 7.92 ±.015	ins. 8.31	ins. 2.36	ins. 1.8	lbs. oz. 178 0	lbs. oz. 2 0	lbs. oz. 180 0	Soft	8.05	No	No	No	Nil	Small capacity shell.
8", Mark II.	0/11/67	Nil	19.4	ins. 7.92	ins. 8.31	ins. -	ins. -	lbs. oz. 175 10	lbs. oz. 4 0	lbs. oz. 180 0	Hard	5	No	Yes	No	Date and x.	
8", Mark III.	9/12/68	1765	19.6	ins. 7.92	ins. 8.31	ins. -	ins. -	lbs. oz. 175 9 1/2	lbs. oz. 4 6 1/2	lbs. oz. 180 0	Hard	5	Yes	Yes	No	Date and x.	Small capacity shell.
8", Mark IV.	7/3/70	1872	19.25	ins. 7.92	ins. 8.31	ins. 1.92	ins. 2.0	lbs. oz. 175 8	lbs. oz. 4 8	lbs. oz. 180 0	Hard	5	Yes	No	Yes	Date, x, and IV. -	
7", Mark I.	0/11/67	Nil	16.4	ins. -	ins. -	ins. -	ins. -	lbs. oz. 112 8	lbs. oz. 2 8	lbs. oz. 115 0	Soft	4.6	No	Yes	No	Date and x.	Small capacity shell.
7", Mark II.	9/12/68	1765	16.5	ins. 6.92	ins. 7.31	ins. -	ins. -	lbs. oz. 112 8	lbs. oz. 2 8	lbs. oz. 115 0	Soft	4.6	Yes	Yes	No	Date and x.	
7", Mark III.	7/3/70	1872	16.5	ins. 6.92	ins. 7.31	ins. 1.685	ins. 1.6	lbs. oz. 112 8	lbs. oz. 2 8	lbs. oz. 115 0	Soft	4.6	Yes	No	Yes	Date, x, and III. -	

\* Limits of error in diameter over the body of Palliser projectiles increased to ±.015, § 1899.  
 † Many 9" and 8" shells of large capacity were made as Mark I., these may be recognised from Mark I. small capacity shells by being 1.3" and 1.0" longer. To facilitate identification Palliser shell with sand-cast bodies have their distinguishing numeral stamped on a rear stud in addition to being cast on the base. § 1872. E on a rear stud denotes that the base has been tested for porous places; this mark was discontinued 1/8/72. x and the date on a rear stud has the same significance as in common shell, table p. 152. On the base of Palliser shell manufactured since 1872 will be found the mark Pal' shell, followed by the calibre, R.L., date, numeral indicating pattern, and letters indicating the nature of iron used. Thus a 10" Palliser shell cast on the 1st January would be marked: Pal' shell, 10 in., R.L., 1 R.C. II. The letters R.C. standing for Ridsdale and Cwmbran.  
 ‡ Ordered to be broken up.

*Palliser Shot.*

*Calibres.*—12", 25 ton, 10", 9", 8", 7" :—Palliser shot resemble the shell very closely,\* indeed, the difference between the present patterns is so slight that it has not been found necessary to introduce more than one projectile for the 12 inch 35 ton and 11 inch guns. See plate, p. 336.

In the earlier patterns there were, however, some differences, a solid 7-inch shot was introduced, but it is withdrawn as a service projectile, though still issued for practice.† The earlier shot were made with small cores, and were a little shorter than the shells.

The hollow in the centre is an advantage in manufacture as it is very difficult to cast such a dense metal well when quite solid, even when apparently sound they were liable to break up. Shot of the earlier patterns may be found with their bases closed by a wrought iron plug hammered in, this was found objectionable as the action of the

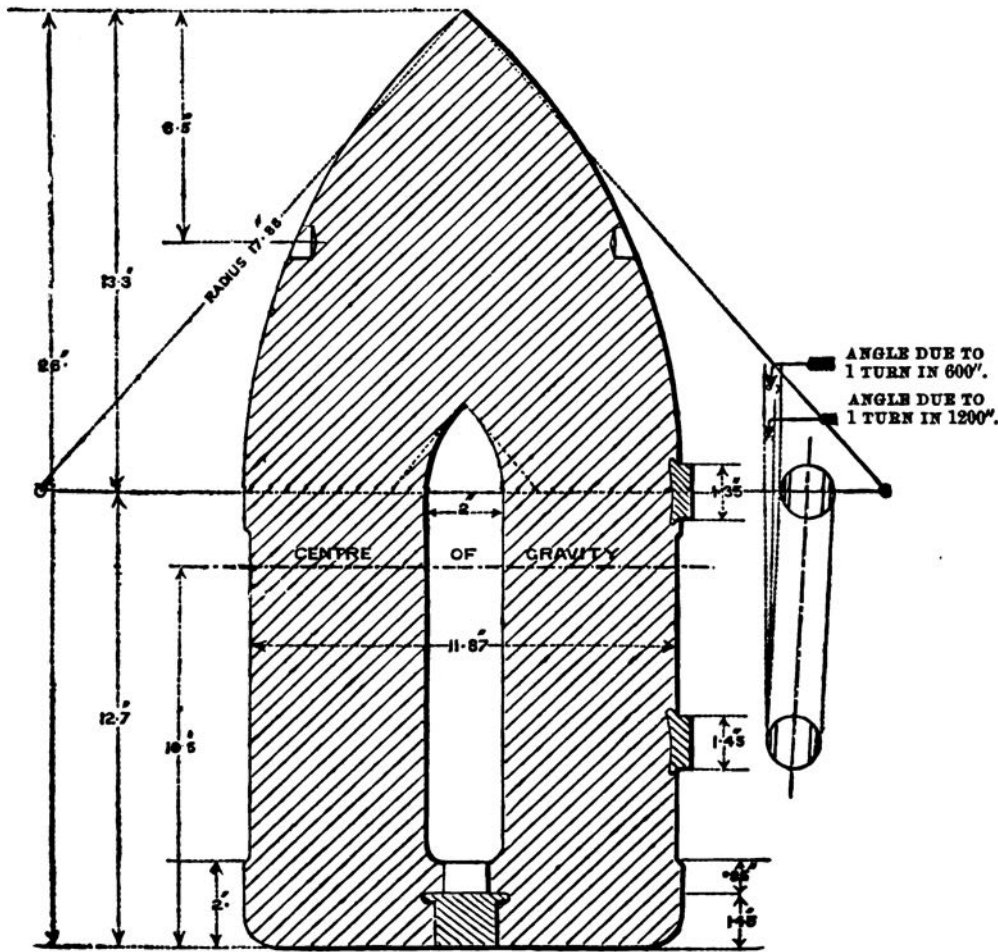

PALLISER SHOT, 12", I.  
(Base closed by a plug hammered in.)

powder tended to drive the plug in, and split the shot when it was fired.‡ Therefore, all Palliser shot of patterns antecedent to those approved

§ 2106.  
§ 2429.

\* So slight is the difference that the 11-inch Palliser shell, Mark II., was originally sealed as a shot, and subsequently its name was changed to shell.

† Solid shot do not shoot as well as cored shot. Extracts, Vol. VIII., p 65.

‡ Extracts, Vol. VIII., p. 65.

7/3/70, were ordered to be returned to Woolwich and to have their § 2040. bases strengthened, this was done by tapping the wrought iron plug, so as to take a wrought iron screw plug with a mushroom-shaped head which projects over and covers the weak part of the shot. Shot so strengthened can be easily recognized by the projecting plug.

The succeeding pattern had a wrought iron bush cast into the base of the shot similar to that used with the shell, into this a *wrought iron* plug was screwed.

Finally, experiments were carried on to ascertain whether the efficiency of the shot would be lessened by increasing the hollow in the interior. The main advantage claimed for shot over shell was that they possessed greater penetrative power in oblique firing than shell.\* It was found desirable to increase the capacity of the shot to get rid of defects in the manufacture due to the form of the cavity.†

Experiments were therefore carried on against iron plates to try the comparative effects of the small cored, and the proposed large cored shot, when fired against iron plates at angles of incidence varying from 60 to 66°. The result was satisfactory, and the large cored shot were approved.‡

In order that these shot may be used as shell with a bursting charge, a gun metal plug similar to that used with the shell is employed to close the base. This use of the shot would be exceptional, therefore no bags are included in the equipment: if it is desired to fire them with bursting charges, bags should be specially demanded.§

\* Extracts, Vol. VIII., p. 65.

† Extracts, Vol. VIII., p. 224. Superintendent R.L. reports a serious defect in the present pattern of cored shot of all calibres, namely, the form of the interior cavity. He has caused a large number to be broken up in course of manufacture, and in every case fissures have been found extending from the rear end of the cavity towards the outside of the projectile. Experience shews that this defect is due to the unnecessary thickness of the shot towards the rear end, to the unequal effect of cooling the front end when it is cast in chill, and the rear end which is cast in sand, and the consequent unequal force exerted in the contraction of the metal. He finds that by enlarging the cavity and assimilating the form to that of the shell this tendency to the production of fissures is apparently obviated.

‡ Extracts, Vol. IX., p. 257.

§ Extracts, Vol. IX., pp. 178-183. Under conditions where the target when struck direct is about a match for the gun opposed to it, Palliser live shell have more penetrative power than shot.

With shot of the form recently introduced, viz., large cored shot which are capable of holding a very fair bursting charge, the effect produced in direct fire appears to be at least equal to that of Palliser shell.

Much information as to the penetration of projectiles will be found in the Extracts above quoted.

9" Palliser Shot, Mark V.

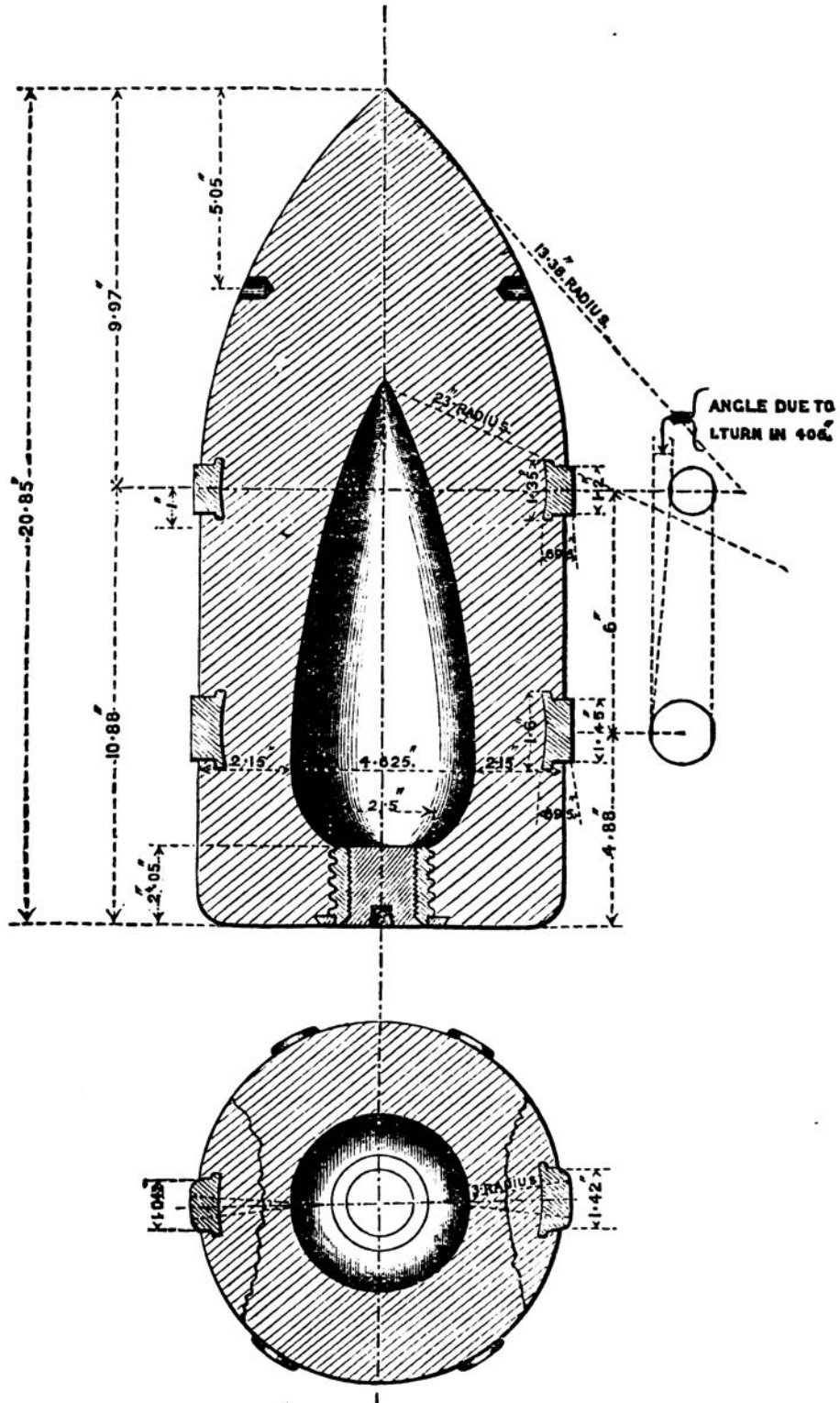



Palliser shot manufactured since 1873 inclusive, are marked on the base with the word shot and with the calibre of the gun, the weight of the gun being added when there are two guns of the same calibre.

For dimensions, &c., *vide* table, p. 170.

Black.\*

Paint.

Loose.

Issue.

Their use, as above pointed out, is similar to that of the shells, but they are considered to penetrate better when firing at oblique angles. Use.

By comparing the drawings of the shell and last pattern shot, it will be seen that the only differences between them are, that the shot is a very little shorter, and that the cavity of the shot contracts more rapidly towards the point than that of the shell.†

### *Wads.*

When the guns are run up violently the projectiles are apt to move forward, especially if the muzzle of the guns are depressed. Several means have been tried to prevent this; a wedge wad has been found to answer, and may probably be introduced, it consists of two wooden wedges about  $6\frac{1}{2}$  inches long, the base being  $1\frac{1}{4}$  inch square, connected by a piece of curved cane about 6 inches long. Wedge. Wads. Exts., Vol. XI, p. 85.

The rammer head has a recess cut in it, into which the wad fits; after ramming home the charge, &c., the rammer is withdrawn a few inches, turned half round to bring the undercut part against the wad, which can then be set home by a smart tap.‡

Various wads have been tried in order to check the destructive escape of gas over the projectile which scores the bore; felt wads and Bolton wads have been tried, and withdrawn as useless. § 2353.

Experiments are being made with metal cups, attached to the base of the projectile, so arranged as to be expanded and pressed against the side of the bore by the action of the powder, but no final result has been arrived at.

\* Those first issued had a white ring painted round the head.

† In the 9-inch the difference in length between the shot and the shell is only  $\frac{1}{8}$  inch, and the difference between the bursting charges is  $1\frac{3}{4}$  lbs.

‡ Grummet wads are supplied on special demand for use with M.L.R. guns at angles of depression. C. 192, A.C., 1871.

## PALLISER SHOT, R.M.L.

Calibre and Mark of Pattern.	Date of Approval.	§ Changes in War Stores.	Length, ± ½ in. per foot.	Diameters.		Thickness of Metal.		Weight empty.	Approximate capacity for bursting charge, shell powder, L.G.
				Body.*	Studs.	Walls (minimum).	Base.		
12-inch, 25 ton, Mark I.	11/11/68	1707	ins. 26·0	ins. ± '01 11·92	ins. ± '006 12·35	ins. 4·935	ins. 2·3	lbs. ozs. ± 1·5 per ct. 600 0	—
12-inch, 25 ton, Mark II.	7/3/70	1872	26·2	11·92	12·35	4·935	2·3	600 0	—
12-inch, 25 ton, Mark III.	{ 14/12/70 Provly.	2038	28·15	{ 11·925 ± '015	12·35	3·0	2·85	600 0	—
12-inch, 25 ton, Mark IV.	6/4/72	2263	28·15	{ 11·925 ± '015	12·35	3·0	2·85	600 0	7 12
10-inch, Mark I. - -	{ 18/9/68 Provly.	1678	24·5	9·92	10·35	3·935	2·3	400 0	—
10-inch, Mark II. -	7/3/70	1872	24·5	9·92	10·35	3·935	2·3	400 0	—
10-inch, Mark III. -	{ 10/1/71 Provly.	2039	25·8	{ 9·925 ± '015	10·35	2·8	2·5	400 0	—
10-inch, Mark IV. -	11/8/71	2107	25·8	{ 9·925 ± '015	10·35	2·8	2·5	400 0	4 0
9-inch, Mark I. - -	21/10/67	1518	18·8	8·92	9·31	—	—	250 0	—
9-inch, Mark II. - -	9/12/68	1765	19·0	8·92	9·31	—	—	250 0	—
9-inch, Mark III. -	7/3/70	1872	19·1	8·92	9·31	—	—	250 0	—
9-in., Mark IV.† - -	—	—	19·1	8·92	9·31	—	—	250 0	—
9-inch, Mark V. - -	16/12/71	2222	20·85	{ 8·925 ± '015	9·31	2·15	2·0	246 4	3 12
8-inch, Mark I. - -	21/10/67	1518	17·15	7·92	8·31	—	—	180 0	—
8-inch, Mark II. - -	9/12/68	1765	17·39	7·92	8·31	—	—	180 0	—
8-inch, Mark III. -	7/3/70	1872	17·4	7·92	8·31	—	—	180 0	—
8-inch, Mark IV. -	16/12/71	2222	18·8	{ 7·925 ± '015	8·31	1·92	2·0	177 6	2 10
7-inch, Mark I.‡ - -	—	—	—	—	—	—	—	—	—
7-inch, Mark II. - -	{ 18/12/66 Provly.	1340	14·0	6·92	7·31	—	—	115 0	—
7-inch, Mark III. -	21/10/67	1518	14·55	6·92	7·31	—	—	115 0	—
7-inch, Mark IV. - -	9/12/68	1765	14·7	6·92	7·31	—	—	115 0	—
7-inch, Mark V. - -	7/3/70	1872	14·7	6·92	7·31	—	—	115 0	—
7-inch, Mark VI. - -	16/12/71	2222	16·1	{ 6·925 ± '015	7·31	1·685	1·6	113 6	1 10

\* Limits of error in diameter over the body of Palliser projectiles increased to ± '015", § 1899.

† Does not appear in changes in war stores.

‡ A few experimental issues, no pattern extant.

## WOOLWICH GUNS.

Radius of head.	Studs, hard or soft.	Distance between Centres of front and of Rear Studs.	Edge of bottom rounded.	Band round shoulder and base.	Bodies cast in sand.	Marks on a Rear Stud, the Date referring to the manufacture of each individual Shot.	REMARKS.
diameter.		ins.					
1½	Hard	7	Yes	Yes	No	Date and × -	Base closed with a wrought iron plug swedged into an undercut, requires strengthening plug § 2040.
1½	Hard	7	Yes	No	Yes	Date, ×, and II.	Base closed with a bush and screw plug of wrought iron. No key-hole in plug.
1½	Soft	7	Yes	No	Yes	Date, ×, and III.	Do., and enlarged core.
1½	Soft	7	Yes	No	Yes	Date, ×, and IV.	Do., do., and gun metal plug with keyhole. Red lacquer.
1½	Hard	8	Yes	Yes	No	Date and × -	Base closed, same as 12", I.
1½	Hard	8	Yes	No	Yes	Date, ×, and II.	Do. do. II.
1½	Soft	8	Yes	No	Yes	Date, ×, and III.	Do. do. III.
1½	Soft	8	Yes	No	Yes	Date, ×, and IV.	Do. do. IV.
1½	Hard	6	No	Yes	No	Date and × -	Do. do. I.
1½	Hard	6	Yes	Yes	No	Date and × -	Do. do. I.
1½	Hard	6	Yes	No	Yes	Date, ×, and III.	Do. do. II.
1½	—	6	Yes	No	Yes	—	Do. do. II.
1½	Soft	6	Yes	No	Yes	Date, ×, and IV.	Do. do. IV.
1½	Hard	5	No	Yes	No	Date and × -	Do. do. I.
1½	Hard	5	Yes	Yes	No	Date and × -	Do. do. I.
1½	Hard	5	Yes	No	Yes	Date, ×, and III.	Do. do. II.
1½	Soft	5	Yes	No	Yes	Date, ×, and IV.	Do. do. IV.
—	—	—	—	—	—	—	—
1	Soft	6·1	No	No	No	Nil - - -	Solid shot, Practice only.
1½	Soft	4·6	No	Yes	No	Date and × -	Base closed, same as 12", I.
1½	Soft	4·6	Yes	Yes	No	Date and × -	Do. do. do.
1½	Soft	4·6	Yes	No	Yes	Date, ×, and V.	Do. do. II.
1½	Soft	4·6	Yes	No	Yes	Date, ×, and VI.	Do. do. IV.

N.B.—The marks on the rear stud are similar to those on the Palliser shell, table, p. 165, and have the same meaning. On the base of Palliser shot manufactured since 1872 will be found the mark Palliser shot, followed by the calibre, R.L., date, numeral indicating pattern, and letters indicating the nature of iron used. Thus a 10" Palliser shot cast on the 1st January would be marked: Pal' shot, 10 in., R.L. †, R.C. IV. The letters R.C. standing for Ridsdale and Cwmbran.

*Case Shot.*

*Case shot.*—Calibres 12", 11", 10", 9", 8", 7".

The case shot for Woolwich guns resemble those previously described for B.L. garrison guns, the studs being omitted, except in the 7-inch M.L. or B.L. case which answers for both guns.

The rule for the weight given on p. 95 is followed, but not very closely, the 7-inch being about three fourths the weight of the other service projectiles, the 8-inch and upwards being about the weight of a round shot of the same calibre.

The reasons for the rule will be found in Extracts, Vol. IV., p. 397. Some of them have become inapplicable as there are no B.L. guns of calibres higher than the 7-inch in the service.

The reasons given are briefly :—

- 1st. To allow of the same case shot being used for B.L. and R.M.L. guns of corresponding calibre. One or two case shot being used with R.M.L. guns according to the range, and to the velocity required for the penetration of the balls.
- 2nd. To secure from rifled guns the same range and penetrative effect as when case are fired in S.B. guns.\*

**Experience.**

The experiments carried on with case shot show that much better results are obtained by using two case shot than by using one, at moderate ranges.†

When the rule of using battering charges (*see* p. 179), when firing at an enemy from a casemate is followed, the effects of two case shot will be still better.

The case carries close, and is effective up to about 600 yards ;‡ much depends on the ricochet of the balls, case will be more effective and to a greater distance over smooth water than over rough. As Shrapnel are withdrawn from the L.S. equipment of Woolwich guns case will be the only projectile available against boats. About 1° of elevation should be given when firing over water at a range of 500 yards, the elevation should be reduced for shorter ranges or when firing over sands.

The dimensions, weights, number of balls, &c., will be found in the tables, page 173. 8 oz. sand shot are employed in all for motives of economy. As before mentioned, much of the weight is expended on the envelope, which is not efficient as a projectile, the segmental linings had to be thickened, until they were found sufficient to protect the bore, and also to prevent the shot from setting up and taking the rifling.

Loose.

**Issue.**

**Drill shot.**  
§ 2267.

*Drill Shot.*—Service projectiles are used at drill to accustom men to their weight, the wooden drill shot formerly issued are withdrawn.

\* The 68-pr. case shot, weight 48 lbs., was fired with a 16 lbs. charge from the 68 pr. (the proportion of charge to shot being about one-third). The 8-inch R.M.L. gun has a full charge of 20 lbs. ; if the case was made the same weight as the other projectiles the proportion of the charge to the shot would be about one ninth.

† Extracts, Vol. V., pp. 51, 137, 228, show that up to 450 yards double shotting is by far the most effective.

‡ Extracts, Vol. IX., p. 108. Trial of 9 and 10-inch case at two rows of targets, showing a front of 63 x 9 feet, the first row 500 and the second 550 yards from the gun ; 5 rounds fired from the 9-inch at 1° 30' elevation gave 129 hits ; 5 rounds from the 10-inch gun at 30' elevation gave 406 hits. The 9-inch seemed to break up 100 yards from the gun and ranged about 1,000 yards, covering a front of about 50 yards at that range, p. 200. Trial of 11-inch case ; 10 rounds were fired against targets arranged as before, at 30' elevation, and gave 1,102 hits. Over smooth water case has been found effective up to 700 yards.

*See also* Vol. VIII., p. 229.

The indifferent results given by the 9-inch case are probably due to the elevation being too great, the other guns were fired at ½°.

The results do not compare favourably with the effects of Shrapnel, *see* p. 155.

## CASE SHOT, R.M.L. WOOLWICH GUNS.

Calibre and Mark of Pattern.	Date of Approval.	§ Changes in War Stores.	Length.	Diameter.	No. of Handles.	Number and Nature of Balls contained.	Approximate weight of Balls.	Approximate weight of case, lining, coal dust, or clay and sand.	Total weight.	Marks on the top of the Case.	REMARKS.
			ins.	ins.			lbs. ozs.	lbs. ozs.	lbs. ozs.		
12-inch, 25 ton, Mark I.	6/5/69	1777	11.35	11.88 ± .05"	2	255 8 oz. sand shot -	127 8	102 8	230 0 ± 5 lbs.	I., B ↗ L, 12-inch, M.L.	Balls packed in coal dust.
12-inch, 25 or 35 ton, Mark II.	{ 30/4/73 5/10/72	2264 2332	11.35	11.88 ± .05"	2	258 8 oz. sand shot -	129 0	117 0	246 0 ± 5 lbs.	II. " "	Do. half sand, half clay.
11-inch, Mark I.	15/4/72	2265	10.9	10.88 ± .04"	2	210 8 oz. sand shot -	102 0	98 0	200 0 ± 6 lbs.	I., B ↗ L, 11-inch, M.L.	Do. do.
10-inch, Mark I.	{ 27/1/68 Provy.	1705	9.6	9.88 ± .04"	2	136 8 oz. sand shot -	68 0	62 0	130 0 ± 4 lbs.	I., B ↗ L, 10-inch, M.L.	Do. coal dust.
10-inch, Mark II.	25&31/72	2188	9.6	9.88 ± .04"	2	139 8 oz. sand shot -	69 8	73 8	143 0 ± 4 lbs.	II., B ↗ L, 10-inch, M.L.	Do. half sand, half clay.
9-inch, Mark III.	24/3/68	1611	9.1	8.88 ± .04"	2	113 8 oz. sand shot -	56 8	43 8	100 0 ± 3 lbs.	III., W ↗ D, 9-inch, M.L.	Do. coal dust.
9-inch, Mark IV.	10/10/71	2115	9.1	8.88 ± .04"	2	113 8 oz. sand shot -	56 8	50 8	107 0 ± 3 lbs.	IV., W ↗ D, 9-inch, M.L.	Do. half sand, half clay.
8-inch, Mark I.	24/3/68	1611	8.4	7.882 ± .035"	1	75 8 oz. sand shot -	37 8	30 8	68 0 ± 2 lbs.	I., W ↗ D, 8-inch, M.L.	Do. coal dust.
8-inch, Mark II.	25&31/72	2188	8.4	7.885 ± .035"	1	75 8 oz. sand shot -	37 8	36 8	74 0 ± 2½ lbs.	II., W ↗ D, 8-inch, M.L.	Do. half sand, half clay.
7-inch, Mark III.	24/3/68	1611	10.25	6.89 ± .03"	1	74 8 oz. sand shot -	37 0	30 0	67 0 ± 2 lbs.	III., W ↗ D, 7-inch, M.L. or B.L.	Do. coal dust.
7-inch, Mark IV.	25&31/72	2188	10.25	6.89 ± .03"	1	70 8 oz. sand shot -	35 0	34 0	69 0 ± 2½ lbs.	IV., W ↗ D, 7-inch, M.L. or B.L.	Do. half sand, half clay.

The 9" and 7", Marks I. and II. (§§ 1241, 1611) are obsolete, being ordered to Woolwich to be broken up. The 12", 10", and 8", Mark I., and the 9" and 7", Mark III. are to be returned to Woolwich for alteration to the present latest pattern, § 2444.



## 8" AND 10" R.M.L. HOWITZERS.

The ammunition for the 8 and 10 inch rifled Howitzers is for the most part in the experimental stage.

Common shell and Shrapnel shell have been tried, but no pattern of Shrapnel has been yet sealed.\*

The small charges used render the construction of a percussion fuze difficult.† The R.L. percussion fuze, Mark II., requires a 7 lb. charge to ensure its action from the 8" Howitzer. A special 30 seconds time fuze has been tried. See Extracts, Vol. XI., p. 53.

8" Common shell.—This is the same as the shell for the 8" gun, except as to the studs, which are made to suit the quick uniform twist of the Howitzer (the twist is 1 turn in 16 calibres). As the twist is uniform, the front and rear studs are of the same size, so the shell can be easily distinguished from that for the gun.

For capacity, &c., see 8" gun shell, table, p. 152.

8" common  
shell.  
§ 2539.

Common Shell, 8" Howitzer.

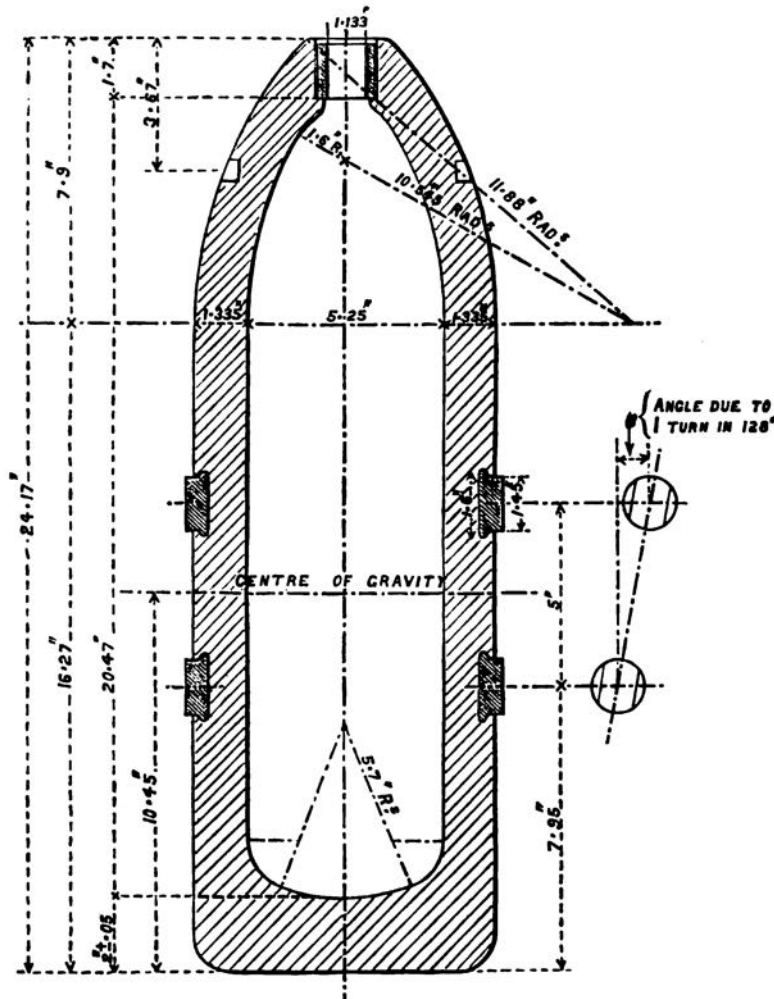

\* A Shrapnel shell studded to suit the quick uniform twist of the howitzer, but otherwise resembling the 8" gun Shrapnel has been made, but is not sealed.

† A fuze on the same principle as the Prussian percussion fuze may prove successful. The striker in the Prussian fuze is kept in its place by a safety pin which passes freely through a hole in the fuze; the pin has a large head projecting beyond the shell. This pin can not fall out while the shell is in the bore, but on leaving it, the centrifugal force causes it to fly out. See "Romberg sur les fusées."

This shell has evidently a large margin of strength as it has only to stand a charge of 10 lbs. in the Howitzer, while it is strong enough to stand a 35 lb. charge. If desired, its capacity could be increased without unduly weakening the shell.

#### INSTRUMENT FOR EXTRACTING PROJECTILES.

Instrument, Extracting Projectiles,  
for Woolwich Guns.

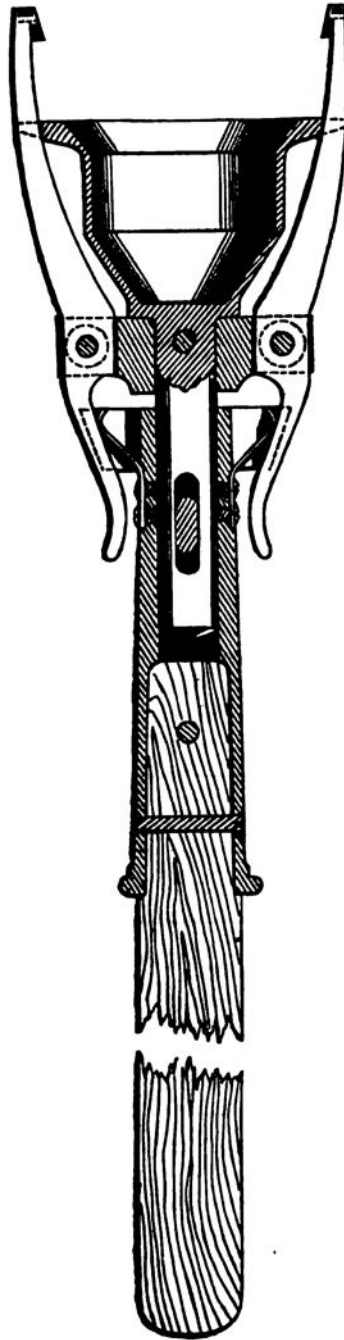

An instrument for the 9" and 7" projectiles, resembling the one described for the 64-pr. M.L. p. 192, was first adopted (24/1/66 and 8/5/66); that for the 9" was only provisionally sealed. 9" Common shell were made with a groove round the head to enable this extractor to work with the grooves of the increasing twist.

The extractor since made for every calibre of Woolwich projectile is constructed on a different principle, so as to act independently of the grooves of the gun.

It has two jaws and teeth for the two extractor holes of the projectile.

The jaws are closed by a strong spring acting on each counterjaw. The increasing twist prevents the use of guides. The extractor is pushed home until the edge of a cup in its head (*vide* figure) bears on the edge of the projectile. It is then turned round until the teeth spring into the holes, which are placed at a fixed distance from the ring on the head on which the cup edge will rest.

On withdrawing the staff the socket moves slightly in a slot in the shaft of the head, bringing two wedges, fixed on each side of each spring, to support each counterjaw.

This extractor has no means provided for releasing its hold while in the bore.

Instrument extracting projectile, rifled M.L. gun. §§ 1206, 1266.

Instrument extracting, 7", 8", and 9"; II. §§ 1363, 1681, 1712.

Mark II., 9"  
and 7".  
Mark I. and II.  
8".  
Mark III.,  
9" and 7".  
Mark I., 12",  
10".  
Marking.

Mark II. for the 9" and 7", and Mark I. for the 8", have smooth staves ; but Mark III. for 9" and 7", Mark II. for the 8", and Mark I. adapted for 12" and 10" have a groove like a screw thread running up the staff to give a better hold to the hand.

Each instrument is marked at the junction of the cup and shaft of the head with the calibre the instrument is for, the numeral, and R  $\uparrow$  L ; some have W  $\uparrow$  D.

One instrument answers for the 10-inch, 11-inch, and 12-inch projectiles ; but the 7, 8, and 9-inch projectiles have each a different instrument.

*Bags for Extracting Instruments.*

Bags for  
extracting  
instruments.  
§ 1734.

There are two sizes of bags made of painted canvas, the mouth constructed to draw round the staff, and tied with small cord running through eyelet holes.

The larger size is for the 12", 11", and 10" extractor ; the smaller for the 9", the 8", the 7", or the 64-pr. extractor.

Each bag is marked I. and R  $\uparrow$  L in white paint.

Holder, shell, Palliser, *vide* Implements, page 53.

Gauges, iron,  
cylinder, shell  
or shot, rifled,  
muzzle-load-  
ing.  
§§ 1546, 1697,  
1714, 2000,  
1313, 1547.

Cylinder gauges are issued to stations of inspection, and also low ring gauges over studs.

The former is important as, being a high gauge for both body and studs, a projectile which passes through it is sure to enter the bore of the gun ; the diameters both of the cylinder and groove are .045 inch less than the corresponding diameters in the gun.\*

Guns with a uniform twist have the front and rear stud of their projectiles the same size, therefore only one set of grooves is required in the cylinder gauge corresponding to the grooves in the gun, the front stud in projectiles for guns having an increasing twist is smaller than the rear stud, hence for 8-inch guns and upwards a cylinder gauge is employed having a second set of grooves, which narrow up to the point so as to test the size of the front stud. A flange round the top of the gauge should rest on the front stud ; a slot cut in the flange allows the front stud to be seen.

Calibres.	Description and Dimensions of Gauges.		
	Ring.	Cylinder.	
	Low. Over Studs.	Over Body.	Over Studs.
12-inch	Inches. 12·345	Inches. 11·955	Inches. 12·365
11 "	—	—	—
10 "	10·345	9·955	10·365
9 "	9·305	8·955	9·325
8 "	8·305	7·955	8·325
7 "	7·305	6·955	7·325

\* In manufacture the cylinder gauge has the advantage of detecting an eccentric stud which could not be found by ring gauges.

*Gauges, iron, ring, shell or shot, R.M.L. body and studs.*§ 2477.  
Ring gauges.

These gauges answer sufficiently well to test the shell as far as loading is concerned; they are issued to H.M. ships in commission, garrison batteries, and control officers, instead of cylinder gauges, the issue of which will be restricted to stations of inspection. They do not test the pitch of rifling, but are much more portable than the cylinder gauges.

The 8-inch and upwards have two sets of grooves, one for the rear and one for the front stud.

The dimensions are given below.

Some skill is required to use a gauge properly; unless held quite fair it will not pass over the projectile. Using.

## RING GAUGE FOR 9-IN. RIFLED M.L. PROJECTILES.



§§ 2477, 2536.

Section.

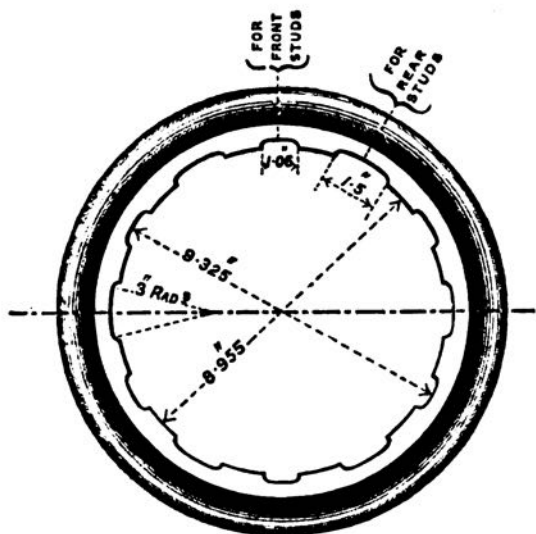

Plan.

Description.	Diameter.		Grooves.		
	Body.	Studs.	Width.	Pitch of Rifling.	Studs.
12-inch 35-ton -	11·955	12·365	ins. .88	ins. 1 in 420	Front.
			1·5	1 in 840	Rear.
12-inch 25-ton -	11·955	12·365	1·25	1 in 600	Front.
			1·5	1 in 900	Rear.
11-inch - -	10·955	11·365	0·8	1 in 385	Front.
			1·5	1 in 770	Rear.
10-inch - -	9·955	10·365	1·13	1 in 400	Front.
			1·5	1 in 700	Rear.
9-inch - -	8·955	9·325	1·06	1 in 405	Front.
			1·5	1 in 802	Rear.
8-inch - -	7·955	8·325	1·08	1 in 320	Front.
			1·5	1 in 640	Rear.
8-inch howitzer -	7·955	8·325	1·5	1 in 128	
7-inch gun - -	6·955	7·325	1·5	1 in 245	

### CARTRIDGES.

1st. Service ("battering" and "full").

2nd. "Reduced."

3rd. Drill or dummy.

The powders used are pebble for all battering charges, and for full charges of 40 lbs. and upwards, L.S. and S.S.; L.G. in the L.S. and R.L.G. in the S.S. for full charges under 40 lbs.\* See p. 282.

\* General results connected with pressure established in experiments by Committee on Explosives, 1872, p. 6:—

(1.) If the powder be burned uniformly in the gun without indication of wave action the pressure increases with the increase of the charge at first rapidly, but after 20 tons on the square inch has been exceeded, then very slowly. It may be remarked that in the whole course of the Committee's experiments a uniform pressure by the crusher gauge of 30 tons in the powder chamber has never been attained. This fact appears strongly to corroborate the experiments of Captain Noble, of Elswick, on the pressures produced by ignited powder in closed vessels, which indicated that the maximum pressure produced by ignited powder in a perfectly closed space is somewhat less than 40 tons to the square inch.

(2.) When a charge of any description of powder is increased beyond a certain limit, wave or local pressures are set up, which strain the gun unduly without affording an equivalent of useful effect on the projectile.

(3.) Provided the battering charge is not exceeded the pressure in the gun increases steadily with the increase of weight of the projectile up to a certain point; beyond this point no material increase of pressure can be obtained by increasing the weight of the projectile. This again corroborates Captain A. Noble's experiments.



There are two classes of service cartridges: battering and full.

The first would be used with Palliser projectiles, and only under special circumstances with common shell;\* the second would be the ordinary charge used with common, double, and Shrapnel shells, and case shot. The reason for using pebble powder with heavy charges has been given on p. 6.

Cartridges for pebble powder are made of two pieces of serge, one rectangular and the other circular; they are coned to fit the chamber of the gun. By reference to the table, p. 185, it will be seen that their diameters is larger when filled with P. than when filled with R.L.G., which latter may be substituted when no P. is available.†

The cartridge for full charges under 40 lbs. and for reduced charges are made in one piece and are cylindrical.

The cartridges are hooped with blue braid (single width up to § 1740. 40 lbs., double width 40 lbs. and over) and choked with worsted; the length of choke is not to exceed 3 inches. All except the 20 lbs. cartridge for the 8-inch and the full and reduced cartridges for the 7-inch have a serge becket over the choke to enable them to be withdrawn from the cylinders. The becket is secured by a few stitches close to the choke so as to keep it out of the way in loading. Cartridges for P. powder are marked both for P. and R.L.G. (as shown in the woodcut).

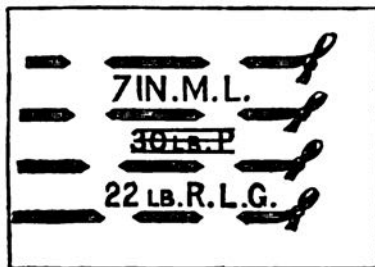

§ 2108.

When P. powder is used the marking for R.L.G. is to be obliterated by lines of printers' ink, § and vice versa when R.L.G. is used.

When R.L.G. powder is used the cartridge is to be made up to the length given in the table by hooping the bags tightly.

The reduced charges are only used for saluting, R.L.G. or L.G. Reduced charge. Exercise powder being employed.

\* When actually engaging an enemy from a casemate battery, it is advisable to use battering charges with all projectiles; the recoil being insufficient when the full charge is used. Extracts, Vol. XI., pp. 100, 103. See also Extracts, Vol. XI., p. 165, where it is stated that common shell may be fired with battering charges when it is desirable to do so, but the 12" 35-ton gun common shell is not to be fired with the battering charge § 2618.

† Committee on Explosives, 1872, p. 3.

The course pursued by the Committee in order to determine the battering charge is "to increase the charge gradually until distinct wave pressures are exhibited, the "highest charge which can be employed without these local pressures appearing" should then be accepted as the battering charge."

‡ This change in diameter arose from the fact of the corrugated powder cases being made to hold cartridges filled with R.L.G. In order that the larger amount of P. powder should fit in, it was necessary to increase the diameter, so as to keep down the length.

§ It is most objectionable to use paint, as it renders the cartridge liable to carry fire.

Some cartridges approved on the 11/1/71 were marked for P. powder only. See table, p. 184.

Experience with serge as a material for cartridges.

Experience has shown that serge is hardly strong enough for the heavier charges; cases have occurred where the cartridges have broken when being packed. It is probable that silk cloth, which is much stronger than serge, will be introduced.\*

A somewhat stouter serge is used for the cartridges for all battering charges, and the 10", 11", and 12" cartridges for full charges.†

In all cases where serge is employed care is taken that it is of good quality; it is tested by the Chemist W.D. to ensure its being made of pure wool; any admixture of cotton would be most objectionable as increasing the tendency to smoulder.

The diameter of the cartridge is made considerably smaller than the diameter of the gun to ensure easy loading; the interval between the cartridge and the gun also facilitates the passage of the flash, causing more rapid ignition. On the other hand, as the pressure varies inversely as the space occupied by the powder the cartridge must not be unduly lengthened, as the force of the powder would be lost. A long cartridge will evidently strain the gun less than a short one, other things being equal.

The position of the vent affects the rate of ignition,‡ but this does not directly affect the cartridge.

As mentioned before, cartridges are not so likely to be injured by insects when kept in the bales in which they are issued when empty.

The dimensions, charges, &c. will be found in the table, p. 184. See also table, p. 305, for particulars as to the amount of materials used in making up cartridges.

The battering charges of P. powder will generally be found to vary between  $\frac{1}{2}$ th and  $\frac{1}{4}$ th, the weight of the projectile; the charge for the 12-inch 25-ton gun is exceptionally light, about  $\frac{1}{4}$ th, and that of the 7-inch is exceptionally heavy, about  $\frac{1}{4}$ th.

Gauges.  
§ 2074.

The diameter of the cartridge is tested by brass ring gauges.

The length can be tested by the universal gauge, which has been provided for filled R.M.L. cartridges, having the lengths marked on one

\* Some trials made showed the comparative strength of silk cloth and serge to be as follows:—

Serge, with the warp, 270; with the weft 250.

Silk cloth, with the warp, 400; with the weft, 300.

† Two natures of serge are used for cartridges.

No. 1, width 54" for all battering charges, and the 12", 11", and 10" cartridges.

No. of strands per inch { warp, 42.  
weft, 41.

Weight per yard, 1 lb.

No. 2, width 54" for 9" and under, except battering charges.

No. of strands per inch { warp, 42.  
weft, 38.

Weight per yard, 14 oz.

‡ Ballistic experiments by Capt. W. H. Noble, R.A., p. 85.

The velocity is greatest when the vent is  $\frac{1}{4}$  of the length of the cartridge from the rear, and least when the vent is at the rear of the cartridge. It has been urged in favour of the rear vent that the cartridge is more likely to be completely expelled.

side and the diameters on the other. There is an arrangement enabling the proper limit to be given in measuring the length.

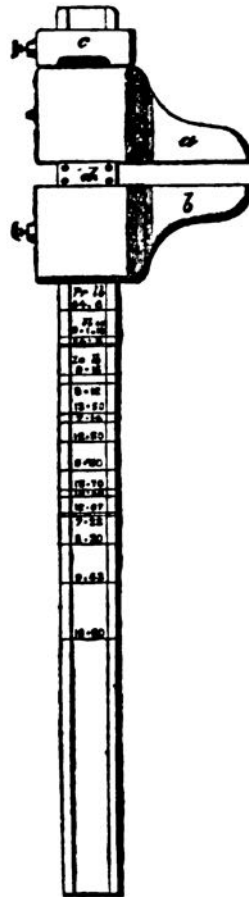

Gauge, cartridge, wood, length, universal.

.....The arm *a* can be set, so as to allow the proper limit, by moving *c*.

It is simply an adaptation of the sliding callipers, having two movable arms, *a* and *b*, which can be placed in position on the slide or scale, on either side of the fixed stop *d*; the scale on that part on which the arm *b* moves is marked on one side with lines corresponding to the "low gauges" of the lengths of all muzzle-loading rifled cartridges, and on the other side with lines representing the diameters of all cartridges; the opposite end of the scale on which the arm *a* moves is marked with lines which represent the difference or "limit" between the "high" and "low gauges" of length.

#### *Directions for using the Gauge.*

1st. For gauging diameters; fix the arm *b* with the inner edge coinciding with the diameter required, and the arm *a* close up to the fixed stop *d*, by means of the sliding stop *c*.

2nd. For gauging lengths; fix the arm *b* with the inner edge coinciding with the line representing the "low gauge" for length, and

fix the sliding stop *c* with the inner edge coinciding with the line representing the difference or limit between the "high" and "low gauges" of length, leaving the arm *a* free to move between the stops *c* and *d*; the low gauge is now obtained by holding the arm *a* against the stop *d*, and the high gauge by holding the arm against the stop *c*.

Gauges, filled,  
cartridges,  
brass, ring,  
rifle gun  
(M.L.)

Brass ring gauges for diameter,—

High gauges are only necessary. They consist of rings of gun-metal, with straight handles; they are marked on and near the handle with the designation and numeral, also the diameter, and the words "FILLED CARTRIDGE," and further where the gauge does not apply to all the cartridges of a gun, as in the case of the 9 and 8 in., which have two gauges each; the weight of the charges of those for which it is intended is stamped on the gauge.

#### RING GAUGES, R.L.G. POWDER.

Designation and Numeral.	Date of Approval.	§ of Changes in War Stores.	Diameter.
12" M.L., I.* - - -	—	—	" 11·0
10" M.L., I.* - - -	—	—	9·0
9" M.L., 43 and 30 lbs., II.† - - -	1/9/68	1695	8·2
9" M.L., 15 lbs., II.† - - -			
8" M.L., 30 and 20 lbs., II.† - - -	1/9/68	1695	7·3
8" M.L., 12 lbs., II.† - - -			
7" M.L., II.† - - -	1/9/68	1695	6·4

§ 2330.

Ring Gauges, "P." powder.

12 inch diameter	11·5 inch.
11 "	10·5 "
10 "	9·5 "
9 "	8·5 "
8 "	7·5 "
7 "	6·5 "

Issue.

Loose, in numbers as demanded.

Issue of  
cartridges.

See tables, giving packing, p. 184.†

With reference to the cases in which they are packed, for land service barrels and boxes would not be used, special zinc cylinders being made for this purpose. *Vide* page 62.

\* Not yet sealed or published in Changes in War Stores.

† Gauge I. is destroyed.

‡ The proportion of cartridges to be kept filled in R.A. charge in times of peace is given in C. 59, A.C., 1872.

When empty the number of each description made up in one bale is as follows :—

12"	{	110 lbs.	}	100		9"	{	50 lbs.	}	150
		85 "						43 "		
		67 "						30 "		250
		55 "		150				35 "		
		50 "						30 "		200
		85 "		100				20 "		300
11"	{	60 "	}	150				30 "		250
		70 "						22 "		
		60 "		150				14 "		400
		44 "								
10"	{	40 "	}	200						

The bales being cased in oiled calico and Hessian. *Vide* page 93.

Waterproof covers have been sealed for special use in the navy for Waterproof 12-inch 25-ton, 35-ton, 10-inch, 9-inch, 8-inch, and 7-inch guns ; they covers. are made of fine cambric, with vulcanized india-rubber attached to one §§ 2048, 2439. side of the material. The special long copper friction tube is used in conjunction with them. *See* p. 69.\*

Patterns of the following cartridges have been sealed for the 8-inch § 2518. R.M.L. howitzer.

*Dimensions filled.*

	Length.	Diameter.
10 lb. - -	8·75" to 9·25"	6·8"
5 " - -	5·75" to 6·25"	6·3"
2½ " - -	4·0"	6·0

For drill cartridge, 8" howitzer, *see* table, p. 188.

§ 2533.

---

\* Extracts, Vol. VII., p. 104, and VIII., pp. 199, 297.



SERVICE CARTRIDGES,

Calibre, Nature and Mark of Pattern.	Date of Approval.	§Changes in War Stores.	Charge, lbs., and Nature of Powder.	Length when filled with P or R.L.G.		Diameters when filled with P or R.L.G.		No. and Description of Braid Hoops.
				From	To	Body.	Bottom.	
12", 35 Ton, Battering, I. -	10/10/72	{ 2373 } { 2607 }	110, P. -	ins. 27'5	ins. 28'5	ins. 11'5	ins. 9'9	16 double width -
12" 35 Ton, Full, or 12", 25 Ton, Battering, I. - }	28 8 71 23 4 72	2103 { 2517 {	85, P., or 67, R.L.G. -	21'5 18'4	22'5 19'4	11'5 11'0	9'9 9'9	11 " }
12", 25 Ton, Battering I. -	16/10/68 and 9/1/69.	1740	67, R.L.G. -	18'4	19'4	11'0	—	9 " "
12", 25 Ton, Battering, I. -	11/1/71	—	85, P. -	21'5	22'5	11'5	9'9	11 " "
12", 25 Ton, Full, I. -	16/10/68 and 9/1/69.	1740	60, R.L.G. -	14'5	15'5	11'0	—	7 " "
12", 25 Ton, Full, I. -	28 8 71	2103 {	85, P., or 50, R.L.G. -	14'25 14'5	15'25 15'5	11'5 11'0	9'9 9'9	7 " " 7 " "
11", Battering, I. -	15 4 72	2269 {	85, P., or 70, R.L.G. -	25'0 24'0	26'0 25'0	10'5 10'0	9'3 9'3	14 " " 14 " "
11", Full, I. -	—	" {	60, P., or 50, R.L.G. -	18'0 18'0	19'0 19'0	10'5 10'0	9'3 9'3	10 " " 10 " "
10", Battering, I. -	8 9 68	1673	60, R.L.G. -	25'0	26'0	9'0	—	12 single width -
10", Battering, II. -	16/10/68 and 9/1/69.	1740	60, R.L.G. -	25'0	26'0	9'0	—	12 double width -
10", Battering, I. -	11/1/71	—	70, P. -	25'0	26'0	9'5	8'25	" "
10", Battering, I. -	28 8 71	2103 {	70, P., or 60, R.L.G. -	25'0 25'0	26'0 26'0	9'5 9'0	8'25 8'25	" " " "
10", Full, I. -	8 9 68	1673	40, R.L.G. -	17'5	18'5	9'0	—	7 single width -
10", Full, II. -	16/10/68 and 9/1/69.	1740	40, R.L.G. -	17'5	18'5	9'0	—	7 double width -
10", Full, I. -	23 8 71	2103 {	44, P., or 40, R.L.G. -	16'3 17'5	17'3 18'5	9'5 9'0	8'25 8'25	" " " "
9", Battering, I. -	20 3 66	1194	43, R.L.G. -	22'0	23'0	8'2	—	11 single width -
9", Battering, II. -	16/10/68 and 9/1/69.	1740	43, R.L.G. -	22'0	23'0	8'2	—	11 double width -
9", Battering, I. -	11/1/71	—	50, P. -	22'5	23'5	8'5	7'3	10 " "
9", Battering, I. -	28 8 71	2103 {	50, P., or 43, R.L.G. -	22'5 22'0	23'5 23'0	8'5 8'2	7'3 7'3	" " " "
9", Full, I. -	20 3 66	1194	30, R.L.G. -	16'0	17'0	8'2	—	7 single width -
8", Battering, I. -	18 1 66	1292	30, R.L.G. -	20'0	21'0	7'3	—	9 " "
8", Battering, I. -	17/1/71	—	35, P. -	21'0	22'0	7'5	6'43	10 " "
8", Battering, I. -	28 8 71	2103 {	35, P., or 30, R.L.G. -	21'0 20'0	22'0 21'0	7'5 7'3	6'43 6'43	" " " "
8", Full, I. -	24 8 66	1292	20, R.L.G. -	15'2	15'7	7'3	—	6 single width -
7", Battering, I. -	18 1 66	1188	22, R.L.G. -	18'3	19'3	6'4	—	8 " "
7", Battering, I. -	17/1/71	—	30, P. -	22'5	23'5	6'5	5'57	11 " "
7", Battering, I. -	28 8 71	2103 {	30, P., or 22, R.L.G. -	22'5 18'3	23'5 19'3	6'5 6'4	5'57 5'57	" " " "
7", Full, I. -	18 1 66	1188	14, R.L.G. -	13'5	14'3	6'4	—	5 single width -
15 lbs. bags - { L.G. - R.L.G. - P. -	—	—	—	—	—	—	—	—
Weight of package empty -	—	—	—	—	—	—	—	—

L.G. powder is used in the L.S. for full charges under the 10", A.C. 7/74.. The letters "L.G." to be marked on the cartridges in red, § 1908.

WOOLWICH GUNS.

Marks.	Number packed, and Weight of Packages, lbs.														Remarks.
	Cases, powder.														
	Copper lined.				Pentagon		Corrugated.								
	Whole.		Half.		Whole.		A.		B.		C.		D.		
	No.	Weight.	No.	Weight.	No.	Weight.	No.	Weight.	No.	Weight.	No.	Weight.	No.	Weight.	
I., 12 in. M.L., 110 lbs., P.	—	lbs.	—	lbs.	—	lbs.	—	lbs.	—	lbs.	—	lbs.	2	292	<p>Previous to 28/8/71 there were separate patterns of cartridges for R.L.G. and P., viz., of a cylindrical form with rounded bottoms for R.L.G. charges, and with a conical and flat bottom for P. By § 2163 it was decided that the cartridges for all battering charges and full charges of 40lbs. and overshould in future be of the shape for P. powder to suit the chambers of the guns, and marked for R.L.G. as well as for P., so that they might be used for P. when R.L.G. is not available, the cartridges being made up to the length specified in the table for charges of R.L.G. by hooping them tightly, they being of larger diameter than those heretofore used for similar charges of R.L.G. When filled with P., the marking for R.L.G. will be obliterated and vice versa.</p> <p>As many of the earlier patterns may still exist, they are shown in the table. The cylindrical cartridge with rounded bottom is still the pattern for full charges under 40lbs. for which P. is not used.</p>
I., 12 in. M.L., 85 lbs., P. }	—	—	—	—	—	—	—	—	—	2	227	—	—		
I., 12 in. M.L., 85 lbs., P. }	—	—	—	—	—	—	—	—	—	2	191	—	—		
I., 12 in. M.L., 67 lbs. -	—	—	—	—	—	—	—	—	—	2	191	—	—		
I., 12 in. M.L., 85 lbs., P.	—	—	—	—	—	—	—	—	—	2	227	—	—		
I., 12 in. M.L., 50 lbs. -	—	—	—	—	—	—	—	—	—	3	207	—	—		
I., 12 in. M.L., 55 P., 50 } R.L.G. - - - - - }	—	—	—	—	—	—	—	—	—	3	222	—	—		
I., 11 in. M.L., 80 P., 70 } R.L.G. - - - - - }	—	—	—	—	—	—	—	—	—	3	207	—	—		
I., 11 in. M.L., 60 P., 50 } R.L.G. - - - - - }	—	—	—	—	—	—	—	—	—	—	—	—	—		
I., 10 in. M.L., 60 lbs. -	—	—	—	—	—	—	—	—	2	172	—	—	—		
II., 10 in. M.L., 60 lbs. -	—	—	—	—	—	—	—	—	2	172	—	—	—		
I., 10 in. M.L., 70 lbs., P.	—	—	—	—	—	—	—	—	2	192	—	—	—		
I., 10 in. M.L., 70 P., 60 } R.L.G. - - - - - }	—	—	—	—	—	—	—	—	2	192	—	—	—		
I., 10 in. M.L., 40 lbs. -	—	—	—	—	—	—	—	—	3	172	—	—	—		
II., 10 in. M.L., 40 lbs. -	—	—	—	—	—	—	—	—	3	172	—	—	—		
I., 10 in. M.L., 44 P., 40 } R.L.G. - - - - - }	—	—	—	—	—	—	—	—	3	184	—	—	—		
I., 9 in. M.L., 43 lbs. -	—	—	—	—	—	—	3	176	—	—	—	—	—		
II., 9 in. M.L., 43 lbs. -	—	—	—	—	—	—	3	176	—	—	—	—	—		
I., 9 in. M.L., 50 lbs. -	—	—	—	—	—	—	3	197	—	—	—	—	—		
I., 9 in. M.L., 50 P., 43 } R.L.G. - - - - - }	—	—	—	—	—	—	3	197	—	—	—	—	—		
I., 9 in. M.L., 30 lbs. -	3	139	—	—	—	—	4	168	—	—	—	—	—		
I., 8 in. M.L., 30 lbs. -	2	109	—	—	2	122	3	137	—	—	—	—	—		
I., 8 in. M.L., 35 lbs., P. -	—	—	—	—	—	—	3	152	—	—	—	—	—		
I., 8 in. M.L., 35 P., 30 } R.L.G. - - - - - }	—	—	—	—	—	—	3	152	—	—	—	—	—		
I., 8 in. M.L., 20 lbs. -	5	149	—	—	5	162	5	147	—	—	—	—	—		
I., 7 in. M.L., 22 lbs. -	5	159	—	—	4	150	5	157	—	—	—	—	—		
I., 7 in. M.L., 30 lbs., P.	—	—	—	—	—	—	4	167	—	—	—	—	—		
I., 7 in. M.L., 30 P., 22 } R.L.G. - - - - - }	—	—	—	—	—	—	4	167	—	—	—	—	—		
I., 7 in. M.L., 30 P., 22 } R.L.G. - - - - - }	5	159	—	—	4	150	5	157	—	—	—	—	—		
I., 7 in. M.L., 14 lbs. -	7	148	3	72	7	161	8	157	—	—	—	—	—		
- - - - -	8	170	—	—	8	183	10	198	13	249	15	285	—		
- - - - -	8	170	—	—	8	183	10	198	13	249	15	285	—		
- - - - -	10	201	—	—	9	198	12	229	14	264	16	300	26 465½		
- - - - -	—	48	—	30	—	61	—	46	—	51	—	56	—		

The above mode of packing is for S.S. In the L.S. cartridges for the Woolwich guns are packed in zinc cylinders, vide p. 62. The 11" gun is for L.S. only.

Reduced or  
saluting  
cartridges.

*Reduced cartridges.\**—As before mentioned, these cartridges are only used for saluting purposes, they are issued to guns of 9-inch calibre and under, and would rarely or ever be used in the L.S. As they are made of serge the rule as to the use of silk cartridges (*see* p. 93) seems to indicate that they would not be used for saluting in the L.S.

As to manufacture and construction, reduced cartridges differ only from the "battering" and "full" in their charges and dimensions, and further in the case of the 7-inch of 10 lbs., Mark I., in the choke being cut off to a length of two inches instead of three; they, like the smaller service cartridges, have no serge beackets over their choked ends. Blank, or Exercise, R.L.G. and L.G. powder is used.

It may be noticed that the diameters of the 9" and 8" reduced cartridges are less than those of the service cartridges; this is necessary in order to lengthen the cartridge and ensure its extending far enough up the bore to reach past the vent, which in the case of the 9-inch gun is 9·7 inches, and in the case of the 8-inch 9·2 inches from the bottom of the bore.†

It will be seen in the tables, p. 187, that the 32-pr. S.B. 10 lbs. cartridge has been approved as a reduced or saluting charge for the 7" R.M.L. gun.

Packing and  
issue.

#### *Packing and Issue.*

For packing and issue, *vide* page 187. The number of empty cartridges of each description made in one full bale is as follows :—

9" of 15 lbs.	-	-	400
8" of 12 lbs.	-	-	400
7" of 10 lbs.	-	-	500

---

\* The name was introduced because it was originally intended to use these cartridges with case shot, but this use was abandoned.

† The long quill friction tube is issued to fire these cartridges.

REDUCED CARTRIDGES, WOOLWICH R.M.L. GUNS. § 1194 AND ERRATA, CHANGES IN WAR STORES, 1866, p. 66.

Calibre and Mark of Pattern.	Date of Approval.	§ Changes in War Stores.	Charge, lbs.	Nature of powder.	Length, inches.		Diameter, inches.	No. and width of braid hoops.	Marks.	No. packed and weight of package, lbs.								REMARKS.
					Cases, powder.					Copper lined.		Pentagon Whole.		Corru- Gated A				
					From	To				Whole.	Half.	No.	Weight.	No.	Weight.	No.	Weight.	
9", Reduced, I.	20/3/66	1194	15	R.L.G. or L.G. Exercise.	11	12	6.8	4 single	I. 9-in., M.L., 15 lbs.	7	154	-	-	7	167	8	168	
8", Reduced, I.	24/8/66	1293	13	"	11.5	13	6.26	5 "	I. 9-in., M.L., 13 lbs.	9	158	4	79	9	171	10	168	
7", Reduced, I.	18/1/66	1188	10	"	9.26	9.75	6.4	3 "	I. 7-in., M.L., 10 lbs.	11	160	4	71	11	173	14	188	
7", Reduced, or 32-pr. S.B. 10 lbs. Mark I.	25/10/70	1977	10	"	10.75	-	6.0	3 worsted	I. 32-pr., 58 or 56 cwt. D., or 7-in., M.L., 10 lbs.	11	160	4	70	11	172	14	182	Approved for future manufacture, its greater length ensuring its being struck by the tube, even when rammed hard home.

DRILL, OR DUMMET CARTRIDGES, WOOLWICH, R.M.L. GUNS.

Calibre and Mark of Pattern.	Date of Approval.	Changes in War Stores.	Length, Inches.	Diameter, Inches.	Diameter decreased at Bottom to Inches.	Imitation Choke on Front End.	Marks.	REMARKS.
13-inch, 35 ton, Mark I. -	2/9/73	2516	From 27.5 To 28.6	From 10.8 To 11.1	From 9.1 To 9.4	No	I, 13-in., M.L., 110 lb. R. & L.	
12-inch, 25 ton, Mark I. -	6/8/68	1659	17.0	10.8	—	Yes	I, 12-in., 54 lb. R. & L. -	Contains hollow wood block, it has two crossed rope becketts at each end.
12-inch, 25 ton, Mark II. -	8/3/70	1878	17.0	10.8	11.1	Yes	II, 12-in., M.L., 54 lb., R. & L. -	Differs from I. in being conical.
12-inch, 25 ton, Mark III. -	27/9/72	2358	20.0	21.0	10.8	No	III, 12-in., M.L., 55 lb., W.R. & L. -	Dimensions increased to those of P. powder cartridges, and made without a choke to admit of being packed in zinc cylinders.
11-inch, Mark I. -	27/9/72	2358	25.0	26.0	9.9	No	I, 11-in., M.L., 85 lb., R. & L.	
10-inch, Mark I. -	27/11/68	1706	17.5	18.5	8.9	Yes	I, 10-in., M.L., 40 lb., R. & L.	Contains hollow wood block, it has two crossed rope becketts at each end.
10-inch, Mark II. -	8/3/70	1878	17.5	18.5	8.9	Yes	II, 10-in., M.L., 40 lb., R. & L. -	Differs from I. in being conical.
10-inch, Mark III. -	27/9/72	2358	25.0	26.0	8.9	No	III, 10-in., M.L., 70 lb., R. & L. -	Dimensions increased to those of P. powder cartridges, and made without a choke to admit of being packed in zinc cylinders.
9-inch, Mark I. -	23/10/67	1508	16.0	17.0	8.15	No	I, 9-in., 30 lb., R. & L. -	The inside is formed of junk, it has two crossed rope becketts at each end.
9-inch, Mark II. -	4/2/69	1763	16.0	17.0	8.0	Yes	II, 9-in., M.L., 30 lb., R. & L. -	Dimensions increased to those of P. powder cartridges, and made without a choke to admit of being packed in zinc cylinders.
9-inch, Mark III. -	8/8/70	1878	16.0	17.0	8.0	Yes	III, 9-in., M.L., 30 lb., R. & L. -	The inside is formed of junk, it has two crossed rope becketts at each end.
9-inch, Mark IV. -	27/9/72	2358	21.0	22.0	8.0	No	IV, 9-in., M.L., 50 lb., R. & L. -	Dimensions increased to those of P. powder cartridges, and made without a choke to admit of being packed in zinc cylinders.
8-inch, Mark I. -	23/10/67	1508	15.2	15.7	7.25	No	I. -	Dimensions increased to those of P. powder cartridges, and made without a choke to admit of being packed in zinc cylinders.
8-inch, Mark II. -	4/2/69	1763	15.2	15.7	7.1	Yes	II, 8-in., M.L., 20 lb., R. & L. -	The inside is formed of junk, it has two crossed rope becketts at each end.
8-inch, Mark III. -	8/3/70	1878	15.2	15.7	7.1	Yes	III, 8-in., M.L., 20 lb., R. & L. -	Contains hollow wood block, it has two crossed rope becketts at each end.
7-inch, Mark I. -	23/10/67	1508	13.5	14.3	6.35	No	I, 7-in., 14 lb., R. & L. -	Differs from II. in being conical.
7-inch, Mark II. -	4/2/69	1763	13.5	14.3	6.2	Yes	II, 7-in., M.L., 14 lb., R. & L. -	The inside is formed of junk, it has two crossed rope becketts at each end.
7-inch, Mark III. -	8/3/70	1878	13.5	14.3	6.2	Yes	III, 7-in., M.L., 14 lb., R. & L. -	Contains hollow wood block, it has two crossed rope becketts at each end.
7-inch, Mark IV. -	27/9/72	2358	22.5	23.5	6.2	No	IV, 7-in., M.L., 30 lb., R. & L. -	Differs from II. in being conical.
6-inch, howitzer, Mark -	23/5/73	2533	8.75	9.25	6.7	Yes	I, 6-in., M.L., how., 10 lb., R. & L.	Dimensions increased to those of P. powder cartridges, and made without a choke to admit of being packed in zinc cylinders.

By § 1839, Changes in War Stores, the following alterations were ordered to be made in future manufacture, without a change of pattern, viz., the rope becket to be removed from the base end of cartridges, and the becket at the front end set nearer the circumference to make it easier for a wad hook to catch them. Commanding officers were permitted to make these alterations, at their discretion, to such cartridges as had been issued to them, and also a rope's end with a tuft of loose yarn as an imitation choke.

\* These limits in diameter were approved 8/3/70, § 1878 Changes in War Stores to supersede those given in § 1839, besides those given at the time of sealing each pattern.

**Drill Cartridge.\***—Is made of a hollow wood block covered with hide, and the nature of gun and charge marked on it. Drill cartridge. §§ 2358, 2533.

Loose in numbers as demanded.

Issue.

They are now made of the same size as P. powder cartridges, and without the imitation choke in order to admit of their being packed in zinc cylinders. For details &c., see table, p. 188. The 12" III., 10" III., 9" and 7" IV. will supersede those of previous pattern when the existing store is used up.

Proof cartridges hardly come into a Laboratory course. The following occurs in Extracts, Vol. xi., p. 80:— Proof cartridges.

"It has been found difficult to fix a proof charge which will ensure a heavier pressure on the gun without unduly straining it. Powder chosen within the proper limits strain the gun to very different extent when large charges are used, e.g., one brand of Pigou and Wilks, "P." gave pressures ranging from 20 to 24 tons per square inch, with a charge of 58 lbs., projectile 250 lbs., while another brand gave a pressure of from 26 to 44 tons, with the same charge."

The following proof charges have been decided on:—

10-inch	tons, 75 lbs.,	Pebble powder.
9 "	58 "	"

The dimensions of the empty cartridges are†:—

			Length.	Diameter.
10"	-	-	33·75"	9·5"
9"	-	-	42·75"	8·5"

\* Mark I. drill cartridges, 7", 8", and 9", were stuffed with junk, and were found to set up on ramming home, and so to allow the rear ring of studs to get beyond the rifling into the powder chamber where the rifling ceases, and so cause the shot to jam.

† Brown braid is used in making up these cartridges. Flat-headed cylinders are fired at proof, as the service ogival-headed projectiles would be dangerous to fire at the butts.



## CHAPTER XIII. — AMMUNITION FOR 64-PR., 80-PR., 40-PR., AND 25-PR. R.M.L. GUNS.

---

COMMON AND SHRAPNEL SHELL.—CASE SHOT.—GAUGES.—CARTRIDGES,  
AND STORES CONNECTED WITH THEM.

---

It will be convenient to consider the siege guns, and guns of position above enumerated together, as the ammunition for them is very similar, occupying, as they do, an intermediate position between the Woolwich guns and the field guns.

The projectiles\* used with the above guns are :—

Common shell,  
Shrapnel shell,  
Case shot.

The manufacture of 64-pr. guns† on the shunt principle has ceased, but a large number of S.B. guns have been converted to 64-pr. rifled guns ; these take the same ammunition as the shunt gun, although they are rifled on a different principle. The calibre of the 64-pr. guns are very nearly the same, the shunt being 6·3", and the converted gun 6·29"; the twist of rifling is the same in both guns, viz. 1 turn in 40 calibres.

*The shunt system* has been considered inferior to the Woolwich, because besides being unnecessarily complicated, the grooves which are cut with abrupt sharp angles weaken the gun.‡ The principle is as follows :—The studs of the shell bear on the deep side of a double groove on entering, and on the shallow side on leaving the bore, thus loading easily, yet leaving the muzzle tightly gripped with a stable axis. This

---

\* It is not considered necessary to have a Palliser projectile for any calibre under 7-inch.

An experimental Palliser shot weighing 89·44 lbs. was fired from a gun of 6·29" calibre, its muzzle velocity was 1,290 ft. per second. The energy or vis viva of the

shot per inch of its circumference in tons =  $\frac{W V^2}{2 \times g \times 2240 \times \pi \times D} = 53\cdot1$ .

This energy would render the projectile just a match for the "Warrior" at close quarters, as her figure of resistance is given as 53, while it would be rather more than a match for ships of the "Minotaur" class, whose figure is given as 51.

By Professor Bashforth's tables the energy can be calculated at any ordinary range ; at 100 yards its energy would be reduced to 51, it would then be a match for ships of the "Royal Sovereign" class, whose figure of resistance is given as 50.

Ships now generally carry heavier armour, therefore Palliser projectiles less than 7-inch calibre would be ineffective against them, but might be found useful against granite forts. In the American war common shell were found to be ineffective against stone walls, though they answered well against brickwork.—See Gilmore's Siege of Fort Pulaski. The Prussians have introduced a hardened shell (for use against iron-plates and strong masonry), for a canon de 15c (5·8" about), throwing a shot of about 78 lbs., with a charge of about 13½ lbs. of prismatic powder. In velocity, about 1,525 feet.—See Revue d'Artilerie, February 1874.

† The 64-pr. will take 32-pr. S.B. ammunition ; 32-pr. solid shot is fired from this gun at practice by the reserve forces, but 32-pr. case is not used with this gun, as it scores the bore.—Extracts, Vol. X., p. 169.

‡ In the case of the two guns which burst, the steel tubes split in the direction of the sharp angles of the grooves, and the Committee are inclined to think that the angular form of the groove in the shunt system, for the greater part of the length, may possibly have promoted the ultimate disruption of the tubes. The Woolwich form of groove is free from the defect due to sharp angles. The Superintendent, Royal Gun Factories, in a letter to the Ordnance Select Committee, attributes the failure of the 13" gun, among other causes, to the gun having been rifled on the shunt system.—Vide Extracts, Vol. V., p. 99.

may be easily explained:—A rifled projectile, both on entering and leaving the bore, is driven by a force acting along its axis, and rotation is given by the stud coming against the spiral formed by the edge of the groove, thus in figure, if the projectile were pushed base first, the stud

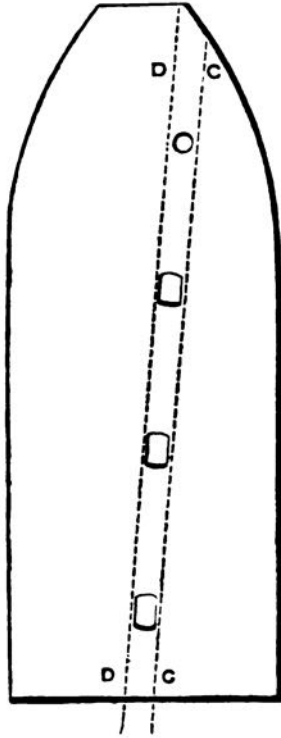

would move against the loading edge C C of the groove, while if pressure were applied to the base so as to move it point first, the studs would meet the driving edge D D and work along it; in the shunt gun, however, in addition to the mere fact of the driving side of the double groove being shallow, and the loading side deep, the two grooves join in one deep one at 2 feet 7·5 inches from the muzzle, each stud thus running down the deep side into the common groove, and returning up the common groove and shallow side, just as a railway engine shunts from one line to another by backing on a common piece, into which both are made to lead. The shallow groove does not break with an abrupt step into the single groove, but by a gradual incline, the exact details of which belong to the gun factory. It may be noticed also that at the bottom of the bore, one groove is made to narrow slightly so that after running along the loading edge, each stud is brought to touch the driving edge just at the bottom of the bore; this saves it from bounding on to it with a blow on the first impulse from the charge.

The studs are of copper; there were formerly five, but now three only to each groove; they are attached by swedging or staving into undercut holes; their form is cylindrical with the sides bevelled off to a certain extent.

The 64-pr. R.M.L. projectiles may be easily recognised by their having three rings of copper studs, three in each ring, whilst formerly they had five rings of studs, three in each ring. It is necessary to employ a soft metal to allow the studs to be compressed when firing from the shunt gun, and to prevent shearing, a larger bearing surface is desirable, this latter point is attained by having three rings of studs.

It is necessary to keep down the size of the stud, as otherwise the shell would not stand the strain in the operation of pressing in the studs.

The dimensions of grooves and studs are as follows:—A section of the deep groove gives a depth of ·11 inches, width at bottom ·6". The incline of the edges is given by tangents drawn from each side of the groove to a circle concentric with the bore 1·7" radius. The shallow or "pinching" groove whose driving edge is in the production of that of the deep groove (*i.e.*, at a spiral of 1 in ·40 calibres), decreases in depth by ·025" in the first 12·6" incline, and by ·005" the next 12·6", from which it runs at a constant depth of ·08" to the muzzle, where the deep groove has so far shunted from it as to give a step or shallow groove ·4 inches wide. The width of the stud is ·55 inches, so that it must always partly extend over the deep groove. The height ·125" shows that for any part to enter the shallow groove it must undergo a compres-

sion or wearing down of  $\cdot 01$  inch; supposing the compression to be equal on all the studs, it would be  $\cdot 005$ " on each.

The windage over the body of all shunt projectiles is  $\cdot 08$ ", over the studs  $\cdot 04$ ", the clearance is  $\cdot 015$ ", and the play of the stud is  $\cdot 18$ ".

In the 64-pr. converted gun the plain groove is employed, the edges are angular and slightly rounded off.\*

Shooting of converted guns.

It is well to remark that the shooting of the converted gun is good, although there is a very large amount of play between the side of the groove and the stud, this seems to indicate that the studs of the projectiles for other guns might be reduced in width without detriment to the shooting, and if so, considerable manufacturing advantages would follow.

Common shell, § 1768.

*Common Shell.*—Gauge, G.S., Fuzes 9 or 20 seconds M.L., Mark II. or III.,† Pettman's G.S. percussion, or R.L. screw percussion, Mark II. All shells have extractor holes in prolongation of the grooves.

The Mark showing the pattern of the shell will be found between an extractor hole and the row of studs.

Extractor. §§ 1205, 1712.

The extractor holes are placed in prolongation of the row of studs. The extractor has three guides which keep in the grooves and bring the

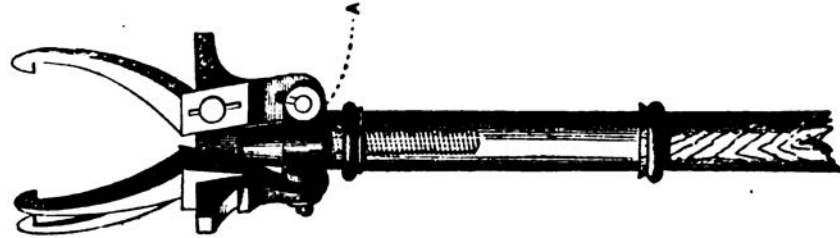

teeth of the jaws over the extractor holes; by turning the handle, the collar, A, attached to the jaws recedes or advances, opening or closing the jaws by means of pins attached to the collar, which work in slots in the jaws.

Issue.

Generally filled for S.S., fuzed with Pettman's G.S. fuze, and issued loose. For L.S. would generally be issued empty, loose.

For dimensions, bursting charges, &c., see page 198.

\* For particulars and drawings of groove of both shunt and converted guns, see Text Book, Rifled Ordnance, pp. 125, 126, 1st edition.

The following dimensions in the converted 64-pr. show the clearance, play of studs, and windage over body and studs:—

	Inches.		Inches.
Calibre of gun	$6\cdot 29$	Calibre of gun + depth of grooves	$6\cdot 51$
Diameter of shell	$6\cdot 22$	Diameter of shell + height of studs	$6\cdot 47$
Windage over body	$\cdot 07$	Windage over studs	$\cdot 04$
Height of stud	$\cdot 125$	Width of groove	$\cdot 73$
Depth of groove	$\cdot 11$	„ stud	$\cdot 55$
Clearance	$\cdot 015$	Play of stud	$\cdot 18$

The play of stud is much greater than in any other gun, but that given above is approximate only, as the thickest part of the stud does not enter the groove owing to the clearance.

§ 2485.

† Mark I. M.L. fuzes to be used up when available in the district. In future they will only be issued to S.S. for services other than field and boat guns.

*Shrapnel Shell.*—Gauge, G.S. Fuzes, 5 or 9 sec. M.L.,\* Mark II. Shrapnel shell. or III., or R.L. Screw percussion, Mark II. Its internal arrangements § 2209. are similar to those described for the B.L. 64-pr., from which it differs in having studs, extractor holes, &c.

MARK III.

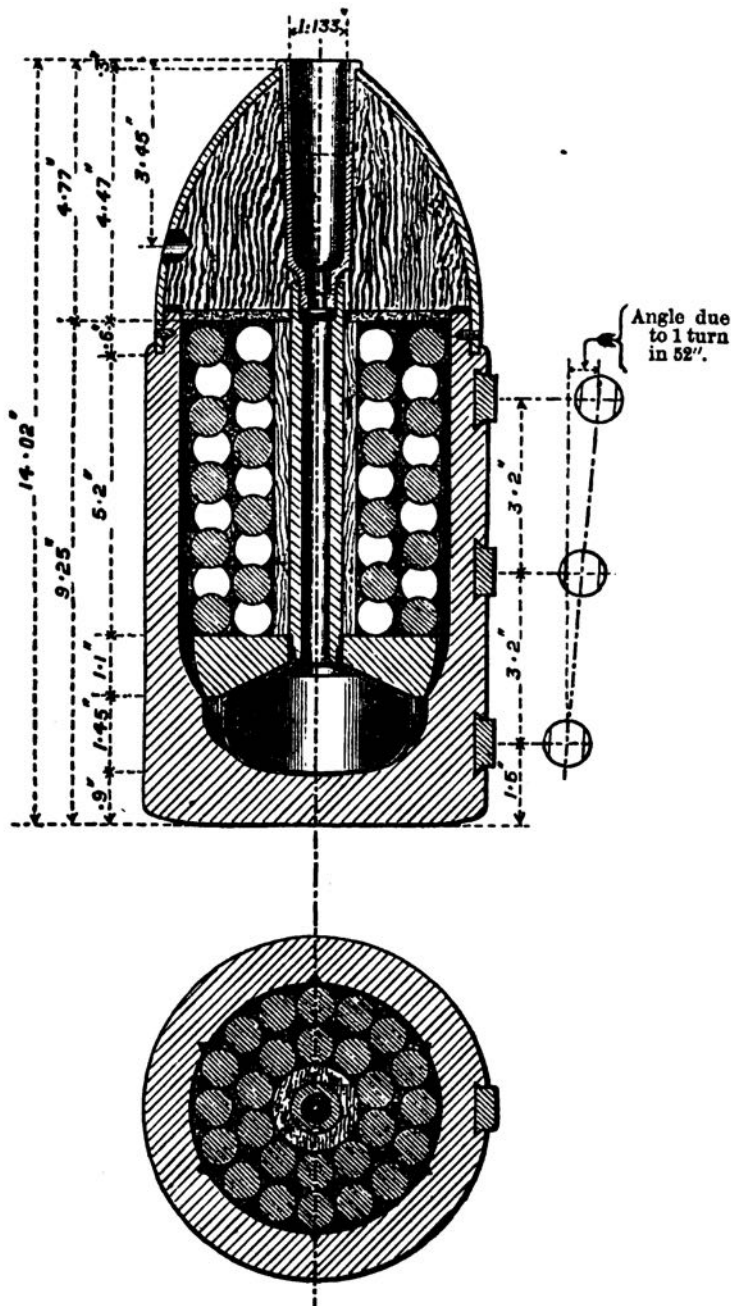

In the latest patterns the following changes have been introduced:— § 2491. The socket has been made flush at the top, this renders the head less liable to injury in transit, or on grazing when fired; a strong gun-metal socket replaces the composite socket of tin and gun metal which serves

\* Mark I. M.L. fuzes to be used up when available in the district. In future they § 2485. will only be issued to S.S for services other than field or boat guns.

to receive the fuze; the bottom of the socket is screwed to receive the brass primer, the iron tube fits on to the end of the fuze socket, and is made larger in diameter to facilitate loading;\* and the underside of the diaphragm, and the top of the tin cup are shaped conically, as shown in the drawing, to facilitate unloading.

The flush-socket will be found in all new pattern Shrapnel. The strong gun-metal socket in all from the 40-pr. to the 12" inclusive, and the large tube will be found in all calibres from 64-pr. to 12" inclusive.

In filling Shrapnel shell, *vide* p. 52, the bursting charge will be found to occupy a portion of the tube, care must therefore be taken to make sufficient room for the primer by tapping the shell with a wood mallet, or by shaking it.

Issue. For S.S. filled and boxed, primer fixed, and marked as usual. Empty, § 2357. loose for L.S.

Case shot. For dimensions, bursting charges, &c., *vide* table, p. 199. §§ 2188, 2266. *Case shot* resembles that described for 64-pr. B.L. guns, except that, of course, it has no studs. For dimensions, &c., *see* p. 200.

Owing to the difference in the calibre of the B.L. and M.L. case, the same case shot cannot be made interchangeable for the two 64-pr. guns B.L. and M.L. as is done with the 7".

The 64-pr. M.L. case shot is used in the 80-pr. gun, and the latest patterns are marked 64-pr. or 80-pr.

Issue. Loose.

#### 80-pr. R.M.L. (Converted) Gun.†

80-pr. R.M.L. This gun is the same calibre as the 64-pr., but is considerably heavier gun. (weight about 95 cwt). It differs from the 64-pr. gun in the rifling, § 2220. requiring corresponding changes in studding the projectiles.

The twist of rifling is 1 turn in 40 calibres, the form of groove resembles the Woolwich groove.

The projectiles are heavier, except the case shot, which is common to both guns; the gun also fires a heavier charge.

The studs in the projectiles are made of pure copper, as the shells are greatly strained on pressing in the studs. There are two rings of studs, three in each ring; the front studs are much smaller than the rear ones, to enable them to be fixed with less pressure.

§ 2278. 80-pr. Common Shell.—Gauge, G.S. Fuzes 9 and 20 secs. M.L.O. (Mark II. or III.), † Pettman's G.S. and R.L. screw (II.) percussion.

\* Up to the 40-pr. inclusive the tube is  $\frac{3}{4}$ " wide and fits into the socket; over 40-pr.,  $1\frac{1}{2}$ " wide and fits outside the socket; and where the tube is of iron, it lacquered internally.

† The calibre of the gun is 6.29", the diameter of gun and projectile are as follows:—

	inch.		inch.
Diameter of gun	- - 6.29	Width of groove	- - 1.3
„ shell	- - 6.22	„ rear stud	- - 1.22
	=====		=====
Windage over body	- .07	Play of stud	- - 0.08
	=====		=====
Diameter of gun + depth of grooves	- - 6.57	Height of studs	- - 0.15
Diameter of shell + height of studs	- - 6.52	Depth of grooves	- - 0.14
	=====		=====
Windage over studs	- 0.05	Clearance	- - 0.01
	=====		=====

§ 2485. † Mark I. M.L. fuzes to be used up when available in the district. In future they will only be issued to S.S. for services other than field and boat guns.

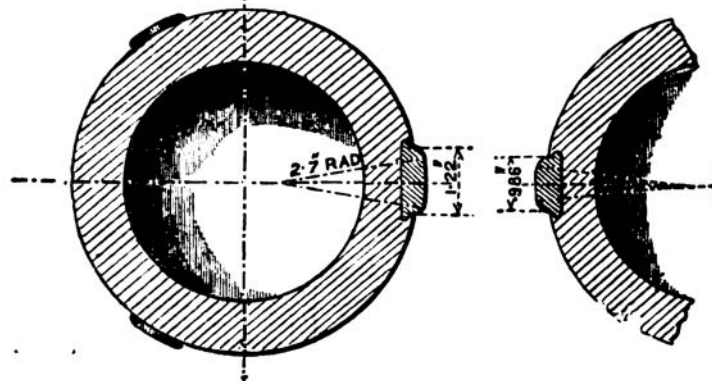
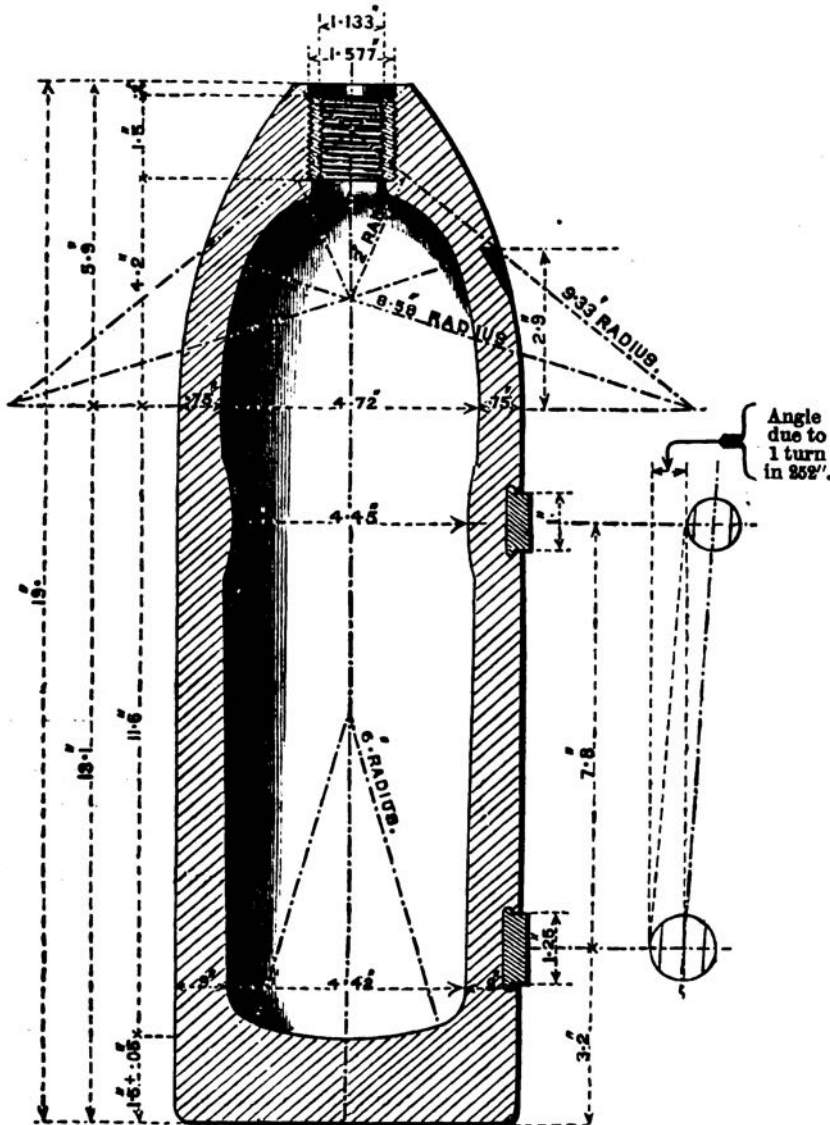

80-PR. COMMON SHELL. MARK L.



The construction of the shell is peculiar (the form is given in the woodcut), in order to strengthen the shell sufficiently to bear the strain of pressing in the studs; it is cast with a band of increased thickness under the front stud; the thickness of the shell increases gradually towards the base.

For dimensions, bursting charge, patterns, and other details, *vide* table, p. 198.

- Issue.** For L.S., empty, loose.
- Shrapnel shell.** *Shrapnel Shell.*—Gauge, G.S. Fuzes, 5 or 9 seconds M.L., Mark II. or III.,\* and R.L. screw percussion, Mark II.  
The 80-pr. Shrapnel resembles in construction the 64-pr., p. 193.  
For dimensions, bursting charge, &c., *vide* table, p. 199.
- Issue.** For L.S., empty, loose.
- Issue.** *Case Shot.*—The same as 64-pr., *vide* table, p. 200.  
Loose.
- Extractor.** *Extractor.*—The extractor for the 80-pr. is on the same principle as § 2362. that for the Woolwich guns, *see* p. 175.

40-pr. R. M.L.

40-pr. R.M.L. gun.†

The calibre of this gun is the same as that of the B.L. gun, viz., 4·75", it is rifled with 3 grooves of the Woolwich form, and the rifling is uniform, 1 turn in 35 calibres.

The studs on the shells are made of gun metal, there are two rings of studs, with three studs in each ring, in other respects the projectiles resemble the 64-pr. shells.

- Common shell.** *Common Shell.*—Gauge, G.S., Fuzes,\* 9 and 20 secs. M.L., Mark II. § 2503. or III., Pettman's G.S. or R.L. screw percussion (II).  
The gun-metal socket in this shell is not countersunk. (For dimensions, &c., *see* table, p. 198.)
- Issue.** For L.S., empty, loose.
- Shrapnel shell.** *Shrapnel Shell.*—Gauge, G.S., Fuzes,\* 5 or 9 secs. M.L., Mark II. or III., and R.L. screw percussion, II.  
The construction is given in the cut, it resembles the larger Shrapnel shell previously given.  
For dimensions, changes in patterns, &c., *vide* table, p. 199.
- Issue.** For L.S., empty, loose.

§ 2485.

\* Mark I. M.L. fuzes to be used when available in the district. In future they will only be issued to S.S. for services other than field and boat guns.

	inch.				inch.
† Calibre of gun	4·75		Calibre of gun + depth of		4·95
Diameter of shell	4·69		grooves	-	-
	—		Diameter of shell + height of		4·93
Windage over body of shell	·06		studs	-	-
	—		Windage over studs	-	·02
Height of stud	·12		Width of groove	-	·8
Depth of groove	·10		„ stud	-	·76
	—		Play of stud	-	·04
Clearance	·02				—

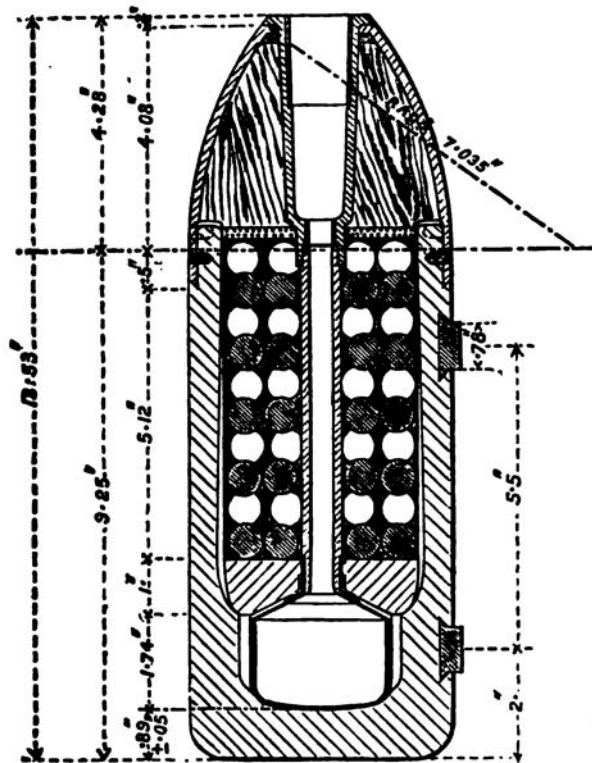

40-PR. SHRAPNEL SHELL. MARK I.

*Case Shot* is of the usual construction, but more nearly resembles the *Case shot* field service case than that for the 64 and 80-pr.

The body is made of tin, in three parts, soldered together; the base is made of a tin disc soldered to the body, and strengthened by having a wrought-iron ring riveted on to it, so as to support the segmental lining; it has a wrought-iron disc laid on loose inside, three wrought-iron segmental linings, lead and antimony balls packed in clay and sand, and has a wrought-iron top, with a handle attached, secured by bending down the fringed edge of the body, and by solder.

For number of balls, dimensions, &c., see table, p. 200.

Boxed.

The gauges used in testing projectiles are as follows:—

Issue.  
Gauges.

Description.	Diameter.		Grooves.		
	Body.	Studs.	Width.	Pitch.	
64-pr. { Cylinder - - -	6.255"	6.485"	—	—	§§ 1546, 2477, 1313.
{ Ring, body and studs -	"	"	{ .6" top	} 1 in 252"	
{ Low over studs -	—	6.465"	{ .7" bottom		
80-pr. { Cylinder - - -	6.255"	6.545"	—	—	§§ 2410, 2477, 2361.
{ Ring, body and studs -	"	"	1.3"	1 in 252"	
{ Low over studs -	—	6.525"	—		
40-pr. Ring, body and studs -	4.73"	4.942"	—	—	§ 2537.

## COMMON SHELL, 80, 64, 40, and 25-pr. R.M.L. GUNS.

Calibre, and Mark of Pattern.	Date of Approval.	§ Changes in War Stores.	Length $\pm \frac{1}{16}$ per foot.	Diameter.		Thickness of Metal.			Weight empty.	Approximate bursting Charge Shell Powder L.G.	Weight of filled Shell. Limits of error $\pm 1.5$ p. cent.	Number of Rings of Studs.	Gauge of Rize Hole.	REMARKS.
				Body.	Studs.	Top.	Walls.	Bottom.						
80-pr., Mark I.	16/5/72	2278	19.0	inches. $\pm .01'' \pm .005$	inches. $\pm .005$	inches. .75	inches. .9	inches. $\pm .05''$	lbs. oz. 71 4	lbs. oz. 8 12	lbs. oz. 80 0	2	General Service.	
64-pr., Mark I.	3/12/64 Provly.	1042	14.71	6.22	6.47	.76	.76	1.3	59 8	4 8	64 0	5	Moorsom	Black lacquer. Issued for practice only.
64-pr., Mark II.	4/1/67 Provly.	1393	16.0	6.22	6.47	.76	.76	1.3	57 9	7 0	64 9	3	"	Larger capacity, 3 rings of studs. Black lacquer.
64-pr., Mark III.	18/2/67	1394	16.0	6.22	6.47	.76	.76	1.3	57 9	7 0	64 9	3	General Service.	
64-pr., Mark IV.	17/2/69	1768	16.0	6.22	6.47	.76	.76	1.3	57 9	7 0	64 9	3	"	Unloading hole.
40-pr., Mark I.	23/5/73	2503	13.53	4.69	4.93	.8	.8	1.2	35 5	2 10	37 15	2	"	
25-pr.														

In front of one front stud in the 80 and 64-prs. and below the stud in the 40-prs. will be found the mark of pattern and R  $\nearrow$  L. The 64-prs. have studs of pure copper; those of the 80-pr. are also of copper, to which a little zinc is added, while those of the 40-pr. are of gun metal. Shell having the Moorsom gauge require conversion by an adapter.

SHRAPNEL SHELL, 80, 64, 40, and 25-pr. R.M.L. GUNS.

Calibre, and Mark of Pattern.	Date of Approval	Changes in War Stores.	Length + $\frac{1}{16}$ " per	Diameters.		Thickness of Metal.			Number and Nature of Balls contained.	Weight of Shell empty.	Weight of bursting Charge, Pistol or F.G. Powder.	Gauge of Rize Hole	Number of Rings of Studs.	REMARKS.
				Body.	Studs.	Top.	Bottom.	Base.						
80-pr., Mark I.-	4/9/72	2379	inches 15.8	inches $\pm .01$	inches $\pm .005$	inches .8	inches .9	inches 1.0	288 lead and antimony, 14 per lb.	lbs. oz. $\pm 1.5$ p.cent. 77 7	lbs. oz. 0 9	G.S.	3	
80-pr., Mark II.	11/7/73	2491	15.13	6.22	6.53	.8	.9	1.0	Do. do. -	77 6	0 9	"	"	Finish socket.
64-pr., Mark II.*	21/3/68	1609	14.02	6.22	6.47	.76	.81	.9	do. do. -	64 3	0 5	"	"	
64-pr., Mark III.	5/2/72	2209	14.02	6.22	6.47	.76	.81	.9	Do. do. -	64 7	0 9	"	"	Metal socket, larger tube, diaphragm and cup coned.
64-pr., Mark IV.	11/7/73	2491	13.55	6.22	6.47	.76	.81	.9	Do. do. -	65 10	0 9	"	"	Finish socket.
40-pr., Mark I.-	23/5/73	2504	13.53	4.69	4.93	.595	.62	.89	180 do. at 18 per lb.	39 1 $\frac{1}{2}$	0 5	"	2	
25-pr.														

\* 64-pr., Mark I. (1424), with cast-iron diaphragm, and without a tin cup, is unserviceable, and when returned to Woolwich is broken up. The mark of pattern, and R  $\uparrow$  L will be found under one front stud.

CASE SHOT, 80-pr., 64-pr., 40-pr., and 25-pr. R.M.L. GUNS.

Calibre, and Mark of Pattern.	Date of Approval.	\$ Changes in War Stores.	Length in inches.	Diameter, inches.	Number and Nature of Balls contained.	Approximate Weight of Balls.	Approximate weight of Case, Linings, Clay, and Sand, &c.	Total Weight.	Marks on the top of the Case.	REMARKS.
64-pr., Mark I. -	24/3/68	1611	9.6 ± .1	6.2 ± .03	56, 8 oz. sand shot -	lbs. ozs. 27 6	lbs. ozs. 20 10	lbs. ozs. 48 0 ± 1.12	I. W. ↑ D, 64-pr. M.L.	Coal dust.
64-pr., or 80-pr., Mark II.	25 & 31/1/73 & 29/4/72.	2188 & 2266.	"	"	49, 8 oz. sand shot -	24 8	26 8	51 0 ± 2	II. W. ↑ D, 64 or 80-pr. M.L.	Clay and sand.
40-pr., Mark I. -	23/5/73	2479	9.75	4.69 ± .025	405, lead and anti- mony balls, 16½ per lb.	24 8	13 14	38 6 ± 1 lb.	I. W. ↑ D, 40-pr. M.L.	Do.
25-pr.										

## CHARGES AND CARTRIDGES FOR R.M.L., 64, 80, 40, and 25-prs.

The powder used in all these cartridges is at present L.G. R.L.G. A.C. 7/74. powder has been used and will again be reverted to when the stock of § 1998. L.G. is used up or withdrawn; the advantage of the latter powder has been pointed out on p. 6. Exercise L.G. or R.L.G. is used for Blank.

The service cartridges are made of serge, and the blank cartridges for L.S. are made of silk. The choke of all these cartridges is cut to a length of one inch. For dimensions, packing, &c., see table, p. 202.

**64-pr. cartridges.**—The service charge is 8lbs.; the cartridges are marked in accordance with the rule given on p. 92. 64-pr. cartridges. § 1044.

The cartridge is cylindro-conoidal in shape, the serge being cut in one piece, and sewn with an overlap, and three rows of worsted stitches down one side of the body of the cartridge and round the conoidal end.

The hoops are worsted braid, secured as given on p. 128. The choking is worsted as for S.B. guns.

**Blank cartridge.\***—Two different cartridges are sealed for this gun, one of silk, which would be used in the L.S. in accordance with the rule given on p. 93, the other of serge would be used for S.S. Blank cartridge. §§ 1044, 1780, 2282, 2283.

**80-pr. service cartridge** resembles the 64-pr. in construction; the charge is 10 lbs. 80-pr. cartridges. §§ 2281, 2638.

The silk cloth cartridge for the 64-pr. is approved for use as a *blank cartridge* for this gun.

**40-pr. service cartridge** is made in two pieces, being cylindrical in shape, the bottom being formed of a disc sewn on to the body of the cartridge, in other respects it resembles the 64-pr. cartridge; the charge is 7 lbs. 40-pr. cartridges. § 2476.

**40-pr. blank cartridge.** Pattern not yet approved.

Empty cartridges are issued in bales in the following numbers, or less:—

64-pr., 8lbs. or 6lbs.	-	-	-	600
64 or 80-pr., 5 lbs.	-	-	-	800
80-pr., 8lbs. or 6lbs.	-	-	-	400
40-pr. „ „	-	-	-	600

**The drill cartridges** for the 64-pr., 80-pr., and 40-pr. guns, generally resemble those described for the Woolwich guns, p. 189; their dimensions are given in the table, p. 203. Drill cartridges.

**Brass ring gauges** are issued to test the diameter of the cartridge. The gauges are as follows:— Brass ring gauges for cartridges.

				Diameter.
				Inches.
80-pr. or 64-pr.	-	-	-	6·0
40-pr.	-	-	-	4·3
25-pr.	-	-	-	-

Loose, in numbers according to demand.

The length of the cartridge can be tested by the gauge, length, universal, see p. 181 in the event of the length of a cartridge not being marked on it, it can be ascertained from the tables, p. 202, and marked. Issue. Gauge, wood, length, universal. § 2074.

\* Sometimes called "reduced," this is a naval term, the 64-pr. R.M.L. guns being originally introduced for S.S.



SERVICE and BLANK CARTRIDGES, 80-pr., 64-pr., 40-pr., and 25-pr. R.M.L. GUNS.

Calibre, and Mark of Pattern.	Date of Approval.	§ Changes in War Stores.	Charge.	Length, inches.	Diameter, Inches.	No. and Descrip- tion of Hoops.	MARKS.	No. Packed and Weight of Package, lbs.											
								Cases, powder.				Copper lined.							
								Pentagon.		Corrugated.		Whole.		Half.		Whole.		Corrugated.	
								No.	Weight.	No.	Weight.	No.	Weight.	No.	Weight.	No.	Weight.	No.	Weight.
80-pr. { (Service), Mark I. - (Blank), Mark I. -	16/5/72	2281	10	From 11.25	To 11.75	6	4 braid -	I., 80-pr. M.L., 10 lbs.	11 160	4 70	11 172	14 192	Silk cloth cart- ridge. } S.S. only.						
	2/4/74	2633	5	6.5	—	5.8	2 silk -	I., 32, 64-pr. or 80-pr. M.L., 5 lbs.	22 160	10 80	22 173	20 202							
64-pr. { (Service), Mark I. - (Reduced), Mark - " " " " (Blank) "	2/1/65	1044	8	9.2	9.7	6	3 braid -	I., 64-pr. M.L., 8 lbs.	14 162	6 79	14 175	18 192	Silk cloth cart- ridge. } S.S. only.						
	2/1/65	1044	6	7.5	8.0	6	2 braid -	I., 64-pr. M.L., 6 lbs.	19 164	8 79	19 177	24 192							
	6/4/72	2282	6	7.5	—	5.9	2 worsted	I., 32-pr., or 64-pr., M.L., 6 lbs.	19 164	8 78	19 177	23 196							
	26/4/72	2177 and 2283	5	6.5	—	5.8	2 silk -	I., 32-pr., or 64-pr., M.L., 5 lbs.	22 160	10 80	22 173	30 202							
40-pr. { (Service), Mark I. - (Blank), Mark I. -	28/5/73	2476	7	13.75	14.75	4.3	7 braid -	I., 40-pr. M.L., 7 lbs.	16 162	7 78	16 175	21 199	Silk cloth cart- ridge for L.S.						
25-pr. { (Service), Mark I. (Blank).																			

A.C. 7/74 directs the use of L.G. powder for service charges of these guns. (The letters L.G. being marked in red, 1" long on the cartridge, § 1998.) Also that blank or exercise R.F.G. and F.G., may, if considered advisable, where there is a surplus store, be used for blank charges in lieu of blank or exercise R.L.G. and L.G.

DRILL, OF DUMMY CARTRIDGES, 80-pr., 64-pr., 40-pr. and 25-pr. R.M.L. GUNS.

Calibre, and Mark of Pattern.	Date of Ap- proval.	§ Changes in War Stores.	Length, inches.		Diameter, inches.		Diameter, decreased at bottom, inches.		Imitation choke on front end.	Marks.	REMARKS.
			From	To	From	To	From	To			
80-pr., Mark I.-	27/9/72	2358	11.25	11.75	5.8	6.1	3.8	3.5	Yes.	I., 80-pr., M.L. 10 lbs.	
64-pr., Mark I.-	16/9/68	1674	9.2	9.7	5.95	6.05	—	—	"	I., 64-pr., M.L. 8 lbs.	Diameters altered, 6.0" to 5.8", §1839 6" W.S., and finally, 6.1" to 5.8", § 1878, which also authorizes the addition of an imitation choke.
64-pr., Mark II.	8/3/70	1878	9.2	9.7	6.1	5.8	4.0	3.7	"	II., 64-pr., M.L. 8 lbs.	
40-pr., Mark I.-	23/5/73	2534	18.75	14.25	4.2	4.4	3.6	3.8	"	I., 40-pr., M.L. 7 lbs.	
25-pr.											

## CHAPTER XIV.—AMMUNITION FOR 16-PR., 9-PR., AND 7-PR. R.M.L. GUNS.

---

COMMON AND SHRAPNEL SHELL, 7-PR., DOUBLE AND STAR SHELL, CASE  
SHOT, GAUGES, CARTRIDGES, AND STORES CONNECTED WITH THEM.

---

THE French system of rifling\* has been adopted for the field guns. The bottom of the groove is concentric with the bore, the driving edge making an angle of  $70^\circ$  with a radius to the centre of the bore, and the loading edge an angle of  $56^\circ$ . The studs are made of a shape corresponding to the grooves. The driving edge of the groove is an easy inclined plane up which the stud mounts so as to centre the projectile.

In the 16 and 9-prs. the windage over the body is  $\cdot 06''$ , over the studs  $\cdot 02''$ , the clearance before centring is  $\cdot 02''$ , and after  $\cdot 03''$ , the play of the stud in the groove is  $\cdot 04''$ .

The depth of the groove in the 9 and 16-prs. is  $\cdot 11''$ , the height of the stud is  $\cdot 13''$ , the width of the groove is  $\cdot 8''$ , that of the studs  $\cdot 76''$ .

The calibre of the 16-pr. is  $3\cdot 6''$ , that of the shell  $3\cdot 54''$ , the calibre of the 9-pr. is  $3''$ , that of the shell is  $2\cdot 94''$ .

In the 7-pr. the windage over the body is  $\cdot 06''$ , over the studs  $\cdot 02''$ , the clearance before centring is  $\cdot 02''$ , and after  $\cdot 03''$ , the play of the stud in the groove is  $\cdot 05''$ .†

The studs for the 16-pr. are made of gun metal, those of the 9 and 7-prs. are made of zinc in order not to injure the bronze guns first introduced for these calibres, the manufacture of 9-pr. bronze guns has been discontinued, but no alteration has as yet been made with the studs. Zinc is more liable to corrosion than gun metal, hence it is desirable to store projectiles with zinc studs under cover where practicable.‡

The 7-pr. and 9-pr. have the same calibre, but the projectiles of the one gun cannot be fired from the other as the twist is different, the studs also on the 7-pr. are much wider than those on the 9-pr. projectiles.§

Projectiles.

The projectiles fired from the R.M.L. field guns are common and Shrapnel shell, and case shot.|| The 7-pr. has in addition a double shell and a star shell. The star shell can be fired out of the 9-pr. also.

---

\* The system is slightly modified in the 16 and 9-prs., the edges of the grooves being rounded off.

† The calibre of the 7-pr. is  $3''$ , the diameter of the shell is  $2\cdot 94''$ , the depth of the groove is  $\cdot 1''$ , the height of the stud is  $\cdot 12''$ . The width of the groove is  $\cdot 9''$ , that of the stud is  $\cdot 85''$ .

‡ Zinc does not corrode rapidly when not in contact with another metal, but when iron and zinc come together a galvanic action is set up.

§ The case shot would fit in, but the 9-pr. case would not break up in the 7-pr.

|| The Indian Field Equipment Committee recommended equal proportions of Shrapnel and segment shells, and numerous comparative trials were made.

Numerous trials were also carried out with bullet shells, and some good results were obtained. The bullet shell differs from Shrapnel in having the body and head cast in one piece; the bottom of the shell consists of an iron disc secured in a

The Shrapnel shell are the most important projectiles, about  $\frac{2}{3}$  of all the projectiles in the equipment being Shrapnel.

As before pointed out, M.L. time fuzes, Marks II. or III. with increased priming are used for these guns, and for small charges when firing at high angles of elevation, gun cotton priming is used, *see* p. 18.

The R.L. screw percussion fuze is used, Mark II. for the 16-pr., and § 2621, 2622. Mark I. or II. for the 9-pr. and 7-pr. Mark II. will be issued for the 9 and 7-prs., when the present stock of Mark I. fuzes is exhausted.

The R.L. percussion fuze does not answer well with the 7-pr.

There are several 7-prs. in the service.

A steel gun weighing 150 lbs., charge 6 oz.	
A bronze gun     "     200     "     "     8 oz.	
A steel gun     "     200     "     "     12 oz.	§ 2498.

The 6 oz. charge sometimes fails to prepare the percussion fuze to act, the shock being too slight to ensure the guard always shearing the feathers.\* The small charge also causes a difficulty with case shot which frequently does not break up.

The shell for all the guns have the G.S. gauge of fuze hole, the shells for the 7-pr. had originally the common gauge, but this was changed to the G.S. § 2097.

All existing shell were altered to the G.S. gauge in 1871.†

*Common Shell.*—Gauge, G.S., Fuzes, 9 seconds, M.L. II. or III. and Common shell R.L. screw percussion, Mark II. for the 16-pr. and I. or II. for the 9-pr. and 7-pr.

somewhat similar manner to the bottom of a segment shell. In the interior of the shell is a wide iron pipe leading down to an iron chamber; this pipe and chamber contain the bursting charge; round the pipe and above the chamber are arranged bullets secured in rosin; the shell carried a heavier bursting charge and the bullets were more scattered than in Shrapnel shell.

The Special Committee on Rifled Shell Guns report that the results of experiments Extracts, made with 9-pr. R.M.L. Shrapnel, segment, and bullet shells show that the former is Vol. IX., equal to the two latter when burst on graze, and is superior when used to burst p. 212. with a time fuze.

Comparative trials of 16-pr. Shrapnel and bullet shell will be found in Extracts, Vol. X., pp. 45, 120; Vol. XI., p. 42. The Shrapnel shell shows a decided superiority over the bullet shell when used as a time shell. The trial of the bullet shell was suspended pending the results of a trial of 16-pr. common shell burst with picric powder. Extracts, Vol XI., p. 46.

16-pr. common shell have been burst by gun-cotton in conjunction with a fulminate of mercury detonator. When an ounce of gun-cotton was used the shell burst into 262 pieces (about 1 lb. 4 oz. was broken too small to be found); when  $\frac{1}{2}$  oz. of gun-cotton was used the shell burst into 186 pieces. In both cases the shells were filled up with water, which is a convenient and sufficiently incompressible medium for transmitting the force of explosion. Experiments have been carried on at Shoebury to ascertain whether gun-cotton arranged in conjunction with a fuze and detonator can be safely fired in a 16-pr. shell. So far the experiments have been satisfactory.

A trial of some 16-pr. common shell cast with spherical heads (as in the design of the new Russian shell) will be found in Extracts, Vol. XI., p. 115. The idea is that the spherical head when blown off will continue to ricochet. The targets were put up at 1,200 yards, the head ricocheted beyond the targets for about 1,500 yards. The heads of the shell after bursting ricocheted like round shot and fairly straight.

\* *Vide* p. 46. The Mark II. fuze is very uncertain with an 8 oz. charge.

Letter of Assistant Superintendent, R.L., 19/12/78.

† 5 seconds, 10 seconds, and 15 seconds special fuzes were introduced for use with the 7-pr. shells having the common gauge fuze hole. These have been withdrawn from the 7-pr. equipment, they may be used with S.B. shells if required. § 2097. These fuzes were all of one size, but the rate of burning was altered by using different compositions.

The construction of the shell will be seen from the cut. They are all

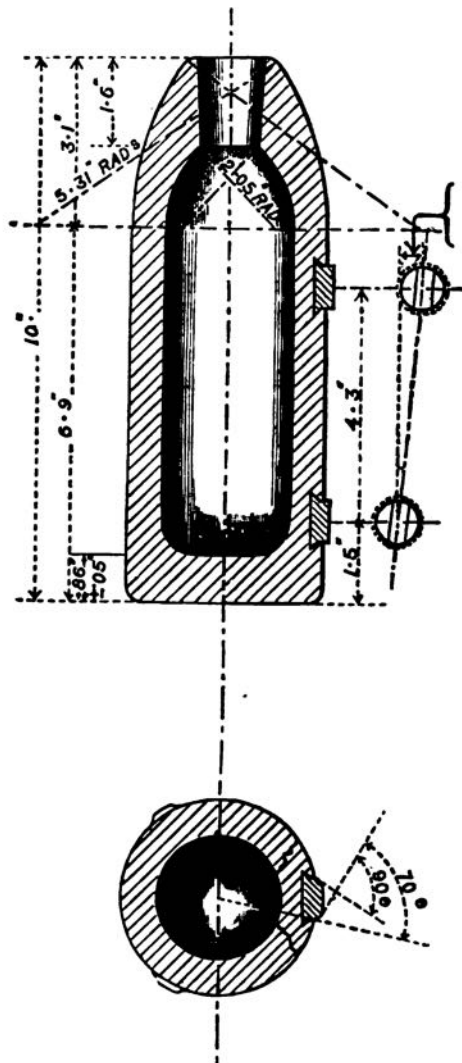

#### 16-PR. COMMON SHELL. MARK I.

lacquered internally. The various patterns, dimensions, &c., are given in the table, p. 211.

Directions for filling will be found at p. 51.

The Mark II. R.L. screw percussion fuze is used with the 16-pr.; Mark I. having proved too weak, *see* p. 46.

These shell when filled have the G.S. wad, *see* p. 57, placed in the fuze hole.

Issue.

1. Filled, wad G.S. inserted, and boxed.

2. Empty, loose. For transit to India, empty, boxed.

The Indian Field Equipment Committee, p. xvii., state that the 9-pr. shell with its charge of  $7\frac{1}{2}$  oz. gives considerable incendiary power, and that its penetration and explosive force are sufficiently great for the destruction of the strongest masonry usually found in villages.

Shrapnel shell.

*Shrapnel Shell*.—Gauge, G.S. Fuzes, 5 seconds M.L., II. or III. or 9 seconds M.L. II. or III. for long ranges, also R.L. screw percussion, Mark II. for the 16-pr. and I. or II. for the 9 and 7-prs.

For dimensions, &c., *see* table, p. 212.

The first pattern introduced for the 16-pr. proved too weak.\* That about to be introduced has no grooves (pattern not yet sealed), and has the coned cup and diaphragm described at p. 194; the studs are of pure copper to avoid undue pressure on the shell in pressing them in: in other respects it resembles the 9 and 7-pr. Shrapnel.

The 9 and 7-pr. Shrapnel resemble the B.L.F.S. Shrapnel, described at p. 119, except that they are studded, and the latest patterns have a flush instead of a projecting socket.

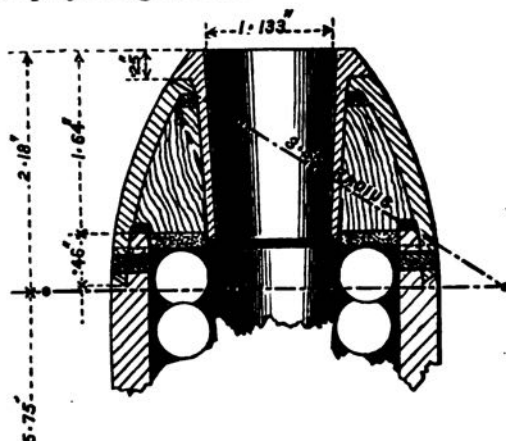

Some 9-pr. Shrapnel having failed at proof, Mark V. has been introduced without any internal grooves, except those in the powder chamber.†

The balls are of lead and antimony. It will be seen by the table, p. 212, that two sizes of balls are used so as to avoid wasting space in the shell.

1. Filled with primer, and boxed.

2. Empty, loose. For transit to India, empty, boxed.

Issue.

Percussion fuzes have been used with good effect. The general result of experiments seem to show that the effect of percussion fuzes would be great when the shell are burst within 10 yards of troops in masses, at long ranges the effect of percussion fuzes is not so good, as the shell tends to bury itself in the earth.

The time fuze would have probably the best effect against open formations, the rule for bursting the shell being similar to that given on p. 120.‡

\* Extracts, Vol. X., p. 242.

† See Extracts, Vol. XI., p. 168. Some of the early pattern Shrapnel shell failed, the attachment of the head not being strong enough. The improvements which render the head firm are the same as those pointed out on p. 120 for B.L. F.S. Shrapnel.

The strengthened head is also an advantage when using a percussion fuze. An account of the defects will be found in Extracts, Vol. IX., p. 292; Vol. X., p. 187.

‡ 9-pr. Shrapnel fired with time fuzes against a column of troops represented by targets 54' x 9' (2 inches thick) in four ranks 20 yards apart made 48 hits through targets 54' x 9' (2 inches thick) in four ranks 20 yards apart made 48 hits through targets per round at 1,200 yards, 40 through at 1,600 yards, and 10 through at 2,000 yards.

The Committee report that Shrapnel loaded with the nose of the shell next the powder may be used as case shot in circumstances of any great emergency with good results.

Extracts, Vol. VIII., p. 85. At 800 yards 9-pr. Shrapnel fired against targets arranged as above, gave 82 hits per round when burst 50 yards in front and 10 feet above the plane; when burst 25 yards in front and 7 feet above the plane, 110 hits per round. The 16-pr. Shrapnel gave 144 hits per round when burst 50 yards in front and 9 feet above the plane; when burst 25 yards in front and 7 feet above plane, 201 hits per round. Extracts, Vol. XI., p. 179.

9-pr. Shrapnel fired at a range of 600 yards, with a percussion fuze, gave very good results; two rows of targets, 54' x 9', were used, 20 yards apart, the practice shows well the necessity of bursting the shell close up to the object; a shell burst



16-pr. Shrapnel. § 2189. 16-pr. Shrapnel.—The Mark I. shell has been withdrawn, but the experiments will give some idea of the power of the gun.

At 2,000 yards with a time fuze the 16-pr. Shrapnel gave very good results against 4 rows of targets, 9' × 9', 20 yards apart, 5 rounds gave 678 hits, 494 being through. At 2,500 yards, using a percussion fuze, the result was bad, the range was rather long for such a fuze, and none of the shell were burst close up to the targets, 5 rounds gave only 78 hits.\*

At targets arranged as above, Shrapnel were fired with a percussion fuze at 1,500 yards, any shell burst within 10 yards gave excellent results, one burst 5 yards off gave 145 hits.

At 2,000 yards, shell burst within 10 yards gave very good results, 1 burst within 5 yards gave 156 hits, while those burst 40 yards off or over produced hardly any effect.

At 2,500 yards the shell became comparatively ineffective, 10 rounds only giving 198 hits, while at 3,000 yards the result was only 13 hits out of 10 rounds.—“Extracts, Vol. X., p. 119.”

This practice shows that percussion fuzes will not answer well at ranges over 2,000 yards.

Some experiments were tried by bursting 16-pr. Shrapnel at various distances in front of targets arranged as above at a range of 800 yards, the result was good when the shell were burst 50 yards from the first row, averaging 116 hits per round, when burst 100 yards off the number of hits was reduced by half, when burst 150 yards off the hits averaged 34 hits per round.—“Extracts, Vol. XI., p. 42.”

Experience with Shrapnel. Active service.

*Experience with Shrapnel (Active Service).*

This has been confined to the campaigns in Abyssinia and the Gold Coast, and to the 7-pr. shell, which did well.† The gun employed was the 150 lb. steel gun, 6 oz. charge.

7-pr. double shell.

7-pr. Double Shell.—Gauge, G.S. Fuzes, 9 or 20 sec.; M.L., Marks II. or III. This shell is intended for high angle firing with a low charge (4 ozs.), its construction is similar to the common shell, it carries a large bursting charge (1 lb.), and would be effective against houses.

Issue.

For dimensions, &c., see table, p. 211.

(1.) Filled and boxed. (2.) Empty, loose. For transit to India, empty, boxed.

10 yards from the object gave 128 hits, one 25 yards off gave 54, one 45 yards off 49, and one 70 yards off gave 26.

Ten effective rounds of 9-pr Shrapnel fired at a range of 800 yards with a percussion fuze against one row of targets, 54' × 9', gave an average of 54 hits per round.

Extracts, Vol. VIII., p. 224.

The results of some experimental segment shell will also be found in the Extracts. 7-pr. Shrapnel, Mark II., 12 oz. charge, range 1,200 yards; 5 rounds gave 97 hits on two rows of targets, 54' × 9'.

\* Extracts, Vol. X., p. 45.

† Vide Extracts from Proceedings, &c., relative to segment and Shrapnel.

Extracts from Col. Milward's remarks on equipment of mountain batteries :—  
“Common and Shrapnel shell good in all respects, but should be fitted for percussion fuzes.”

Extracts from Lieut. Chapman's Journal of Practice :—

8/1/68.—“Two rounds Shrapnel at about 470 yards, 5 seconds fuze. Practice good.”

10/1/68.—“Shrapnel at 700 yards was ineffective.”

11/1/68.—“Two rounds Shrapnel at 450 yards, very effective.”

Action of 10/4/68.—“The Shrapnel and common shell took great effect at ranges from 500 to 1,500 yards,” “the effect of the Shrapnel was considered good.” “55 rounds were fired.”

For experience in the Gold Coast expedition, see Appendix, p. 294.

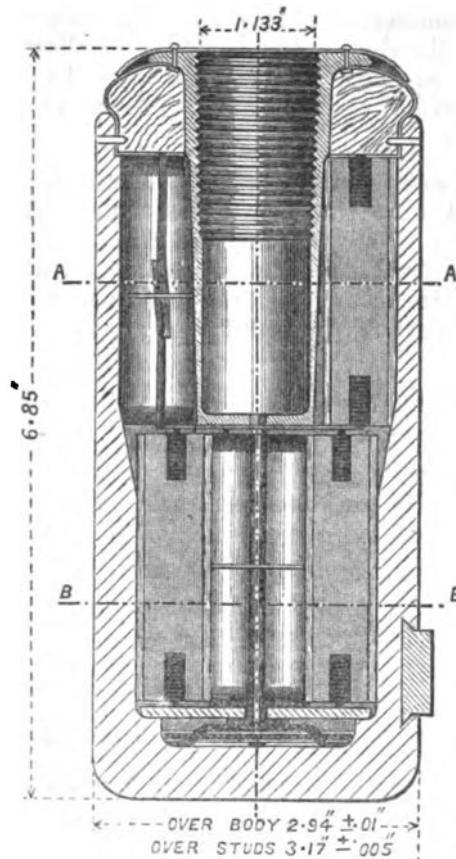

**Star Shell.**—Gauge, G.S.; fuze, 5 sec.; M.L., II. or III. This Star shell. shell has been introduced for use with 7-pr. batteries. It consists of a §§ 2492, 2526. thin iron shell, having a chamber in the base to take the bursting charge ( $\frac{1}{2}$  dram of R.F.G. powder contained in a red shalloon bag); over the bursting charge is a wrought-iron disc with a hole in the centre. The interior is filled with 13 stars, arranged as shown in the figure.

The stars are paper cylinders, filled with the composition given on p. 295; they give a brilliant light and burn about 18 seconds. The top of the shell is made of wood covered with tin, and is lightly attached to the body by rivets, it contains a gun-metal socket, G.S. gauge, to take the fuze, having a fire hole at the bottom. A kit plaster is placed over the head of the shell to secure it from damp. Quick match is wrapt round the stars as shown; it serves to ignite them and to convey the flash of the fuze to the burster.

The shells are issued in boxes, ready for use.

Issue.

To prepare them the kit plaster must be removed, the plug unscrewed, and a 5 seconds M.L. fuze, Mark II. or III., bored to the required length fixed in; it is advisable to add gun-cotton to the priming.

Preparation.

The shell has been fired at high angles at 15 to 27°, and with from 4 oz. to 1 oz. of powder; ranges of from 400 to 600 yards have been obtained.\*

\* 4 oz. charge, elevation 15°, fuze bored to 3, gave 600 yards range; 2 oz. charge, elevation 20°, fuze bored to 1.5, gave 500 yards range; 1 oz. charge, elevation 27°, fuze bored to 1, gave a range of 400 yards. The light was good.—Extracts, Vol. IX., p. 237.

As has already been mentioned this shell has only one row of studs, the front portion of the shell being too thin to allow the studs to be pressed in; the studs are small enough to fit into the 9-pr., from which the shell might be fired if necessary. They form no part, however, of the 9-pr. equipment.

**Case shot.** *Case Shot* generally resembles that described for field service B.L. guns, page 124, except that it has no studs, and the rings, disc, and segmental linings of the 9-pr. are of zinc, to avoid injury to the bore of the bronze gun; each case is marked on the head with the numeral showing pattern, and also the nature of gun it is for. The balls are lead and antimony, packed in a mixture of sand and clay. See table, p. 213.

The 7-pr. case shot frequently does not break up with the 6 oz. charge from the light 7-pr. gun.\*

For dimensions, &c., see Table 213.

**Issue.** In boxes, 10 rounds per box for 7-prs., 8 for 9-pr., and 6 for 16-pr.

**Gauges.** The following gauges are issued for use with the 16, 9, and 7-pr. projectiles :—

#### 1. Cylinder gauges.

	Dimensions.	
	Over body.	Over studs.
9-pr.	2·98"	3·212"
7-pr.	2·98"	3·182"

§ 2555.

#### 2. Ring, body, and studs.

	Dimensions.	
	Over body.	Over studs.
16-pr.	3·58"	3·812"
9-pr.	2·98"	3·212"
7-pr.	2·98"	3·182"

#### 3. Ring, low over studs.

	Dimensions.	
16-pr.	3·795"	
9-pr.	3·195"	
7-pr.	3·165"	

§§ 2554, 2091.

\* The average elevation of case shot from field guns is 1° for 300 yards. Increase or decrease the elevation by  $\frac{1}{4}$ ° for every increase or decrease of 100 yards in range; this applies to such ground as the sands at Shoebury, over swampy ground the elevation might be slightly increased.

7-pr. case shot, fired with 12 oz. charge, all broke up, 1° of elevation did well at 200 yards.

## COMMON SHELL, 16, 9, AND 7-PR., AND DOUBLE SHELL, 7-PR. R.M.L. GUNS.

Calibre and Mark of Pattern.	Date of Approval.	Changes in War Stores.	Length + $\frac{1}{8}$ " Per Foot.	Diameters.		Thickness of Metal.		Weight empty.	Approximate bursting Charge, Shell, Powder, I.G.	Weight of filled Shell.	Gauge of Fuze Hole.	REMARKS.
				Body.	Studs.	Walls.	Base.					
16-pr., Mark I. -	6/1/72	2190	10·	inches, inches, inches, inches, inches. +·01 ±·005	ins. +·05	ins. +·05	ins. +·05	lbs. oz. 14 13	lbs. oz. 1 0	lbs. oz. ±1·5 per cent. 15 13	G.S.	
9-pr., Mark I. -	4/1/70	1921	7·93	2·94 3·2 3·2 3·8	·6	·55	·6	8 8	0 8	9 0	"	Studs, '78" in width, ordered to be reduced to '76".
9-pr., Mark II. -	16/9/71	2104	7·93	2·94 3·2 3·2 3·8	·55	·55	·6	8 8	0 8	9 0	"	Reduced studs, viz., '76".
7-pr., Mark I. -	4/12/65	1153	6·75	2·94 3·17 3·17 3·8	·5	·5	·5	6 14	0 7	7 5	Com-mon.	Fuze hole ordered to be altered to G.S. gauge, § 2097.
7-pr., Mark II. -	11/7/71	2097	6·75	2·94 3·17 3·17 3·8	·5	·5	·5	6 14	0 7	7 5	G.S.	
7-pr., double, Mark II. -	30/12/68	1779	11·25	2·94 3·17 3·17 3·8	·5	·5	·5	11 0	1 0	12 0	Com-mon.	Lighter shell, fuze hole ordered to be altered to G.S. gauge, § 2097.
7-pr., double, Mark III. -	11/7/71	2097	11·25	2·94 3·17 3·17 3·8	·5	·5	·5	11 0	1 0	12 0	G.S.	

7-pr. double shell, Mark I. (§ 1520), obsolete, § 1779.

SHRAPNEL SHELLS, 16, 9, AND 7-PR. R.M.L.

Calibre and Mark of Pattern.	Date of Approval.	§ Changes in War Stores.	Length ± 1/16" per Foot.	Thickness of Metal.			No. and Nature of Balls contained.	Weight of Shell empty.	Weights, Bursting Charge, Pistol, or F.C., from	Gauge of Fuze Hole.	REMARKS.
				Walls.	Top.	Bottom.					
16-pr., Mark I.	6/1/72	2189	10	Ins. .38	Ins. .58	Ins. .58	68, lead and antimony, 18 per lb.	+ 1.5 pr. ct. 16 5	0 1 1/2	G.S.	This shell is too weak, and is to be broken up. Letter from Dr. of Arty. 10/11/73. No internal grooves.
" II.	—	—	"	Ins. .345	Ins. .37	Ins. .45	18 "	9 4	0 0 1/4	"	A pattern of this shell, with a stronger socket than those of previous manufacture, was approved, 5/4/71, § 2062, without a change of pattern. P.S. (plain socket) is marked on one of the studs.
Mark I.	14/1/70	1921	7.98	Ins. .345	Ins. .37	Ins. .45	34 "	9 4	0 0 1/4	"	
" II.	16/9/71	2104	"	"	"	"	"	9 4	0 0 1/2	"	Studs reduced in width from .78" to .76", centre tube of gun metal instead of iron.
" III.*	15/3/72	2210	"	"	"	"	"	9 4	0 0 1/4	"	Junction of head and body stronger, and secured by screw rivets as well as by plain rivets.
" IV.	28/8/73	2525	"	"	"	"	"	9 4	0 0 1/4	"	Flush socket.
" V.	14/4/74	2625	"	"	"	"	"	9 5 1/2	0 0 1/4	"	Do. No internal grooves.
" II.	Provly. 19/3/68	1600	6.5	Ins. .345	Ins. .37	Ins. .45	18 "	7 5	0 0 1/2	"	Wrought-iron diaphragm, cup, fuze hole ordered to be altered to G.S. gauge, § 2097.
" III.*	11/7/71	2097	"	"	"	"	34 "	7 5	0 0 1/2	"	Fuze hole, G.S. gauge.
" IV.*	15/3/72	2210	"	"	"	"	"	7 5	0 0 1/2	"	Junction of head and body stronger, and secured by screw rivets as well as by plain rivets, centre tube of gun metal instead of iron.
" V.	19/1/74	2577	"	"	"	"	"	7 5	0 0 1/2	"	Flush socket.

\* A few shell have been made and issued which have the junction of head and body stronger, and some with all the improvements; these are distinguished by one small star (\*) or two small stars (\*\*) on the studs. 7-pr., Mark I. (§ 1392), with cast-iron diaphragm, and without a tin cup, is unserviceable, and is broken up on return to Woolwich.

N.B.—For diameters, see Table of Common Shell.

## CASE SHOT, 16, 9, AND 7-PR. R.M.L. GUNS.

Calibre and Mark of Pattern.	Date of Approval.	\$ Changes in War Stores.	Length.	Diameter.	No. and Nature of Balls contained.	Approximate Weight of Balls.	Approximate Weight of Case, Linings, Clay, and Sand, &c.	Total Weight.	Marks on the top of the Case.	REMARKS.
16-pr., Mark I. -	8/5/72	2279	inches. 7.1 3.54 ±.05 ±.02	inches. 3.54 ±.02	176, lead and antimony, 16½ per lb.	lbs. oz. 10 9	lbs. oz. 4 10	lbs. oz. 15 3 ±8 oz.	16-pr., R. ↗ L., I. -	Balls packed in clay and sand.
9-pr., Mark I. -	4/7/70	1921	7.4 2.94 ±.1 ±.015	2.94 ±.015	110, lead and antimony, 16½ per lb.	6 12	3 0	9 12 ±4 oz.	9 pr., R. ↗ L., I. -	Balls packed in equal parts of resin and sand.
9-pr., Mark II. -	15/2/71	2060	7.4 2.94 ±.1 ±.015	2.94 ±.015	108, lead and antimony, 16½ per lb.	6 11	3 2½	9 13½ ±6 oz.	9-pr., R. ↗ L., II. -	Outer case in three parts, ring at bottom instead of a disc, balls packed in clay and sand. Knob removed.
9-pr., Mark III.	16/9/71	2104	7.4 2.94 ±.1 ±.015	2.94 ±.015	108, lead and antimony, 16½ per lb.	6 11	3 2½	9 13½ ±6 oz.	9 pr., R. ↗ L., III. -	Balls loose.
7-pr., Mark I. -	4/12/65 Provly.	1153	5.6 2.94 ±.1 ±.01	2.94 ±.01	48, lead and antimony -	6 0	1 8	7 8 ±2½ oz.	I. -	Balls packed in coal dust.
7-pr., Mark II. -	9/9/67	1468	5.2 2.94 ±.05 ±.015	2.94 ±.015	36, 1½ oz. sand shot -	3 6½	1 13½	5 4 ±4 oz.	W. ↗ D., 7 pr., M.L., II. III.	Balls packed in coal dust.
7-pr., Mark III.	31/7/69	1814	4.7 2.94 ±.05 ±.015	2.94 ±.015	82, 1 oz. lead and antimony	5 4	1 10	6 14 ±4 oz.	R. ↗ L., 7-pr., M.L. IV.	" "
7-pr., Mark IV.	26/2/72	2280	4.7 2.94 ±.05 ±.015	2.94 ±.015	70, lead and antimony, 16½ per lb.	4 4	2 0	6 4 ±4 oz.	R. ↗ L., 7-pr., M.L.	Balls packed in clay and sand. (Outer case in three parts.)



## CARTRIDGES.

The cartridges for the 16 and 9-pr. R.M.L. guns are cylindrical, made of two pieces, one rectangular, the other circular; those for the 7-pr. resemble S.B. cartridges, being made of one piece only; they are hooped with braid and choked with worsted, the choke is cut off to a length of one inch. A silk cartridge has been sealed for the 16-pr., and will be introduced when the present stock of serge cartridges is used up; this is hooped and choked with silk. The small charges (4 oz.) for high angle firing from the 7-pr. gun are made up with red shalloon, the thinner material is used to make the choke as small as possible, this is desirable as there is a chance of a small charge turning on being rammed home.

The charges, dimensions, &c. are given in the table, p. 215.\*

As before pointed out, p. 205, there are three different charges for the 7-pr. guns of different weights.

A.C. 7/74.

At present L.G. powder is used for the 16 and 9-prs., but R.L.G. is about to be reverted to for the field artillery. The latter is used for practice with these guns in the R.A., it is better both with regard to velocity and accuracy, *see* p. 6. The sighting of the guns is rather under the mark for L.G. powder. Cartridges made up with L.G. are marked with the letters L.G. in red, to distinguish them from those made up with R.L.G. For blank exercise, R.L.G. or L.G. is used.

§ 1998.

F.G. is used for the 7-pr. cartridges for the reasons given on p. 4.†

Issue.

Generally the same as given on p. 93.

The number of empty cartridges, service and blank, packed in each bale is as follows:—

16-pr., 3 lbs.	-	800	7-pr., 12 oz.,	1,500
„ 1 lb. 8 oz.	1,000		„ 8 oz.,	2,000
9-pr., 1 lb. 12 ozs.	1,000		„ 6 oz.,	2,000
„ 1 lb.	-	1000	„ 4 oz.,	2,000

Blank charges.

The blank charges, *see* table, p. 215, are made up in silk cloth, choked and hooped with silk. There is no blank charge for the 7-pr. gun.

Brass ring gauges for cartridges.

Brass ring gauges are issued to test the diameters of the cartridges, their dimensions are:—

16-pr.	-	-	-	3.3"
9-pr.	-	-	-	2.6"
7-pr.	-	-	-	2.5"

The gauge, "wood, length, universal," page 181, would be used for testing the length.

Issue.

Loose, in numbers as demanded.

\* The 16 and 9-pr. gun carries two filled service cartridges in each axletree box, packed in tin boxes.

† Failing F.G. powder, R.F.G. may be used.

SERVICE, EXERCISE OR SALUTING, AND DRILL CARTRIDGES, 16, 9, AND 7-PR. R.M.L. GUNS.

Calibre and Mark of Pattern.	Date of Approval.	\$ Changes in War Stores.	Charge, lbs.	Length, Ins.	Diameter, Ins.	No. of Hoops.	Material of Cartridge.	Marks.	REMARKS.
16-pr. { Service { Mark I.	12/3/72	2212	3	From 9.5 To 10.0	From 3.8 To -	6 braid	Serge	I., 16-pr., M.L., 3 lbs. -	To govern conversion of 68-pr., 16 lb. cartridges to 16-pr., 3 lbs. To govern supply of silk cartridges after the serge cartridges are exhausted.
	9/11/71	"	"	" " "	" " "	6 silk	Silk cloth	I., 16-pr., M.L., 3 lbs. -	
9-pr. { Exercise, Mark I. Service, Mark I. Exercise, Mark I.	14/2/70	1921	1 1/4	From 5.5 To 6.0	From 2.5 To 2.6	3 " braid	Serge	I., 16-pr., M.L., 1 1/2 lbs.	For 8 cwt. gun. For 6 cwt. gun, S.S.
	25/10/70	1982	1 1/4	From 9.0 To 9.5	" " "	5 braid	"	I., 9-pr., M.L., 1 lb. 12 oz.	
	7/3/71	2047	1	From 8.25 To 8.75	" " "	3 silk	Silk cloth	" " "	
				From 5.75 To 6.25	" " "	3 braid	Serge	I., 9-pr., M.L., 1 lb.	
*7-pr. { 12 oz., Mark I. - 8 oz., Mark I. - 6 oz., Mark I. - 4 oz., Mark I. -	10/5/67	1414	8 oz.	From 4.5 To 5.0	From 2.5 To 2.5	1 worsted	Serge	I., 7-pr., M.L., 12 oz. -	For the steel gun of 200 lbs. For the bronze gun of 200 lbs. For the steel gun of 150 lbs. For use with double shell with both the steel and the bronze guns.
	17/9/67	1471	6 oz.	From 3.5 To 4.0	" " "	"	"	I., 7-pr., M.L., 8 oz. -	
	14/2/69	1781	4 oz.	From 2.7 To 3.0	From 2.2 To 2.2	"	Shalloon	I., 7-pr., M.L., 4 oz. -	
DRILL CARTRIDGES.									
16-pr., Mark I.	10/3/73	2435	-	From 9.5 To 10.0	From 3.15 To 3.3	-	Hollow wood block covered with raw hide	I., 16-pr., M.L., 3 lbs.	
9-pr., Mark I.	5/6/71	2088	-	From 9.0 To 9.75	From 2.4 To 2.6	-	"	I., 9-pr., M.L., 1 lb. 12 oz.	

\* The 3 oz. cartridge for the 7-pr. is obsolete. § 1781.

## CHAPTER XV.—B.L. SMALL-ARM AMMUNITION. SNIDER AND MARTINI - HENRY RIFLES. ADAMS' PISTOL.

THE same description of cartridge is used for all the B.L. small-arms with Snider action in the service, the same cartridge will fit an Enfield rifle or carbine, or a Lancaster carbine. The diameter of the bore is  $\cdot577''$ , the diameter of the bullet is  $\cdot573''$ , small enough to drop through the bore, and depending on expansion for its fit, the length of bullet is about  $1''$  ( $1\cdot04''$  in present pattern), and the length of the cartridge is a very little over  $2\frac{1}{2}''$ . The charge is 70 grs. (very nearly  $2\frac{1}{2}$  drs.) of R.F.G. Each packet of ten rounds weighs about 1 lb.

Many patterns of the Boxer\* cartridge have been made, they are all serviceable with the exception of Mark I., which may be recognised by its having a potët base, formed by pressing out the rim of the base cup so as to form a beading round the edge instead of having a brass or iron base disc as the other marks have. Mark V. is a weaker† cartridge than the others, it may be recognised by its being the only brown paper covered cartridge without a distinguishing ring or rings marked on it, the brass sheet from which this cartridge is made is  $\cdot003''$  thick, instead of  $\cdot005''$  like the later patterns, and its base is not so strong as the earlier ones, the cartridge is not to be issued for foreign service, but is to be expended at home stations.

Construction.

The sketch illustrates the construction of the present pattern of cartridge, which only differs in minor details from the other service patterns.

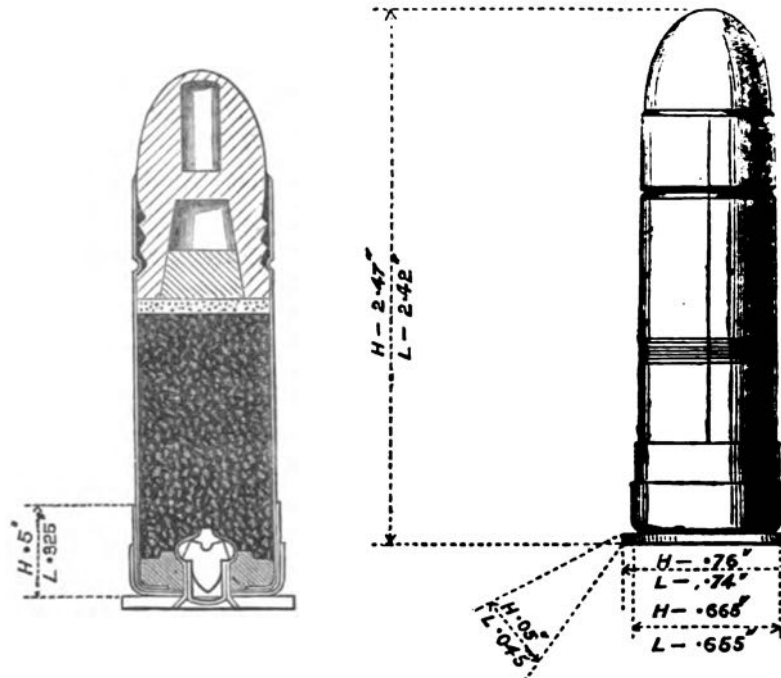

Cartridge, Mark IX., Snider arm.

§ 2436.

\* The name Boxer has been omitted from the nomenclature.

† The case has but one turn and an overlap of  $\cdot3''$  of sheet brass, previous patterns have  $2\frac{1}{2}$  turns of the same sheet brass.

The bullet is made from pure lead, weight 480 grs., the hollow in the head is closed by having the lead spun over it, the hollow parts are necessary in order to get the bullet of a sufficient length for good shooting, without unduly increasing its weight, and to get its centre of gravity in the proper place, the hollow in the base is also used to give the expansive action to the bullets, the plug, made of clay, and soaked in beeswax, closes the rear cavity, and on firing expands the bullet, which has three cannelures, the sides of the bullet as far as the front cannelure are coated with beeswax, the cannelures holding a sufficient supply of the lubricant in their recesses; by the expansion of the bullet the lubricant is squeezed out, and the bore is thoroughly cleaned out by the bullets passing through it. As many as 4,000 rounds have been fired without fouling sufficiently to injure the shooting.

The case is formed of sheet brass covered with brown paper. It is lined with shellac and thin white paper to prevent corrosion from the powder. The case overlaps by about  $\frac{1}{4}$ " and is cemented together with shellac and glue. It is attached to the bullet by being choked into the rear cannelure; the base is strengthened by two cups, and the bottom closed by an iron disc; inside, a paper pellet is pressed against the bottom of the cartridge, a copper cap chamber pierced with a fire-hole passes through the base and rivets the bottom of the cartridge to the case, the top being bulged out over the paper pellet, and the base of the cap chamber being flanged to fit the recess in the iron base disc, the cap chamber holds a brass anvil, on the shoulders of which rests the copper cap, which is primed with cap composition (fulminate of mercury, sulphide of antimony, and chlorate of potash) and varnished. A little wool is placed over the powder to keep it from touching the bullet.

On firing, the cap composition is forced against the point of the anvil, and the flash reaches the charge through the hole in the chamber; the case unwinds, and being pressed firmly against the sides of the bore prevents the gas from escaping in the direction of the breech; after firing, the cartridge contracts to its original proportions, making extraction easy.

The base of the cartridge is very strong owing to its base cups and disc, and it is at the base that strength is essential, indeed if the base is perfect, a very faulty cartridge may be fired without throwing any undue strain on the breech.

The cartridge is found to stand rough usage and wet well, what tries it most is a moist hot climate,\* it is almost impossible to prevent the moist air from penetrating when aided by great variations of temperature. Experiments have shown that it is impossible to explode these cartridges in a mass, thus firing  $\frac{1}{4}$  lb. of powder along with a number of cartridges in an iron cylinder hardly exploded any rounds.

	The first four marks had the brass cylinder covered with white paper.	Marks.
Mark	I. has a potêt base, before described.	§ 1328.
„	II.† has a brass disc, and heavy bullet 525 grains. 4 cannelures.	§ 1448.
„	III. has also a brass disc. The bullet is shorter, the distance therefore from choke to top of case is less, but it is hard to distinguish between II. and III. 3 cannelures.	§ 1449.
„	IV. is the only cartridge which has white paper and iron disc. Bullet has 3 saw-shaped cannelures.	§ 1450.

\* Much information as to the effect of climate on early patterns without paper lining will be found in *Extracts*, Vol. VII., p. 224.

† This cartridge is best suited for the naval rifle, as its long bullet, 525 grains, gives good shooting with the rapid twist of this rifle.

- § 1496. Mark V. is the only brown paper cover cartridge without a distinguishing ring. Brass .003" thick, 4 cannelures.
- § 1703. " VI. has one black ring. " .005" " "
- § 1760. " VII. has one black ring and lead spun over head instead of wood plug. Bullet, 4 cannelures.
- § 1831. " VIII. has two black rings, lined with tissue paper and shellac to prevent corrosion.
- § 2105. " IX. has one red ring, it only differs from VIII. in having a bullet with 3 cannelures of the same size as pattern IV., which was supposed to give better shooting at long ranges.
- Issue. In packets of 10 rounds, bullets all one way, made up in brown paper, *see* p. 220.
- Blank cartridges for B.L. rifles. *Blank Cartridges* are issued in packets of 10 rounds, made up in purple paper.
- §§ 1552, 2271. Blank cartridges are packed 1,300 rounds in a quarter barrel, 2,000 in a half barrel.
- For packing, *see* page 220.
- General Orders, New Series, August 1867. Blank Mark I. without the numeral II. after "rifles" is unsuitable for arms marked II.\* and II.\*\*
- Four patterns of blank ammunition may be met with, all are serviceable.
- § 1451. I. Is a condemned ball cartridge of Mark VIII. or IX. cut down to the required length, the powder of those at present issued is loose, but previously the powder was in the form of a compressed pellet.
- § 1451. II. The case is made of sheet brass not covered by paper, and contains the powder in the form of a pellet.
- § 1552. III. Differed from II. in having a paper case.
- §§ 2332, 2482. IV. Differs from III. in having the powder loose, and in some minor details of construction.

MARK IV. BLANK CARTRIDGE.

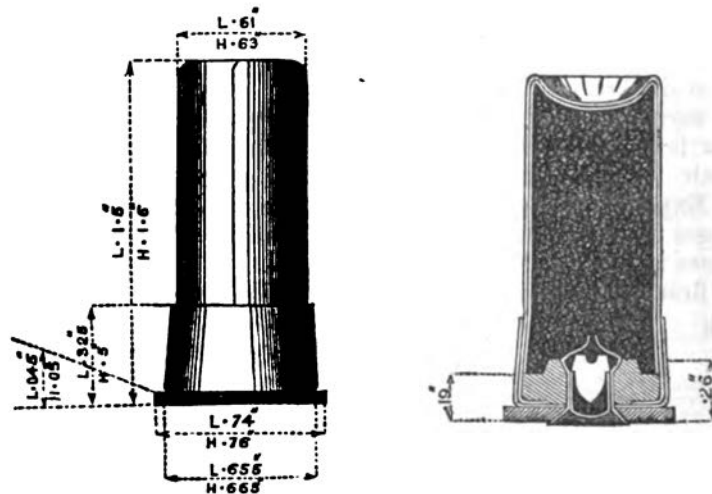

- § 2546. Buck shot. It is suited for either Snider or Martini-Henry rifles.
- Buck Shot Cartridges.*—A special cartridge containing buck shot has been issued to convict prisons; it is adapted for the Snider Enfield. Mark I. charge, in a pellet and shot embedded in plaster of Paris. II. charge, loose and shot in bone dust; the latter is far the most effective. It carries about 50 yards.

*Ammunition for Adams' revolver.*

The cartridge consists of a small brass cylinder with the base attached § 1739, 2227. in the same way as the Snider; the charge is 13 grains of pistol powder, there is no wool between the charge and the bullet; the bullet is pure lead, weighing 225 grains, made up in bundles of 12 in brown paper wrappers. For packing, *see* page 220.

*Martini-Henry Ammunition.*

The bore of the Martini-Henry rifle is  $\cdot 45''$ ; the bullet is made of lead hardened with tin,  $1\cdot 27''$  long, weight 480 grs. (12 lead to 1 tin), its diameter increases from  $\cdot 439''$  at the shoulder to  $\cdot 45''$  at the base; the small hollow in the base of the bullet tends to expand it, and the great length of the bullet causes it to set up in the bore and fill the grooves; the cannellure allows the cartridge to be secured to the bullet by choking. Two cannellures are made in the present bullet to attach it more securely to the case. The charge is 85 grs. of R.F.G.<sup>2</sup> § 2487.

In general construction the cartridge resemble the Snider; the sketch (*see* plate, p. 325) shows its construction. The case consists of two turns and an overlap of  $\cdot 5''$  of  $\cdot 004''$  brass, and in addition to the two base cups has a strip of brass  $\cdot 005''$  thick inserted between the folds of the case at the base of the cartridge. The cartridge is made of a bottle necked shape by crimping in the upper part so as to make it fit into the short chamber of the rifle; before this change was made the cartridge was found to be inconveniently long. The bullet has two turns of fine white parchment paper wrapped round it from right to left and lubricated at the base for about half its length in beeswax, the object of the paper is to prevent leading, and it untwists in passing through the bore.

Over the powder in the cartridge a cardboard disc is placed, then a wad of beeswax,\* and then two more cardboard discs; the bullet is choked in the usual manner into the case; the cartridge is a little over  $3''$  in length.

*Packing.*—In tens, packed heads and tails in brown paper, 10 rounds weigh a little over 1 lb.

*Blank Cartridge.*—The ordinary Boxer blank cartridge, Mark IV., is used with the short chambered Martini-Henry.

---

\* The beeswax wad is hollowed out to ensure its expanding in cold weather.



S.A. AMMUNITION, B.L.

Package.	Tare.	IX. Ball, Boxer, for Snider Rifles, .577 Bore.		I. Ball, Boxer-Henry, for Martini-Henry Rifles, .45 Bore.		III. Blank, Boxer, for B.L. Rifles.		*I. Blank, Boxer, for B.L. Rifles.		I. Ball, Boxer, for Adams' Pistol, .45 Bore.	
		Rounds.	Gross.	Rounds.	Gross.	Rounds.	Gross.	Rounds.	Gross.	Rounds.	Gross.
Barrel { Half Quarter	lbs. oz.	12 2	—	—	—	2000	64 8	2000	79 2	—	—
		7 12	81 4	700	86 6	1300	41 10	1300	52 6	—	—
Box, S.A., Deal, I.	lbs. oz.	7 8	51 0	480	61 8	740	26 12	740	32 12	1680	79 0
		16 0	97 8	840	109 0	1320	51 8	1320	62 0	—	—
Bullock { Camel { Deal { Teak { Small Arms { Mahogany {	lbs. oz.	31 8	283 0	2600	320 0	4130	132 8	4130	175 4	—	—
		4 0	—	—	—	—	—	—	—	600	30 0
Box, Tin-Lined	lbs. oz.	9 8	53 0	480	63 8	740	28 12	740	34 12	1680	81 0
		13 8	71 8	600	79 8	960	38 14	960	46 0	—	—
Case, M.L. { Half Quarter	lbs. oz.	8 0	51 8	480	61 8	740	26 8	740	33 8	1680	79 8
		11 12	69 12	600	77 12	960	37 2	960	44 4	—	—
	lbs. oz.	30 0	181 0	1540	200 0	2400	93 12	2400	113 0	5364	262 6
	lbs. oz.	18 0	76 0	660	91 0	1020	44 14	1020	53 0	2220	112 0

Bullets are issued in Packing Cases containing 500 each.  
 Empty Cartridge Cases are issued in Packing Cases containing 500 each.  
 Note.—The large figures are not Service Packages. \* Converted Cartridges.

Three patterns of Martini-Henry ammunition have been issued.

Mark I. resembles that described above, but the brass was .003' thick.

Mark II. had the brass .004" thick, but the strip of brass between the folds of the cartridge was omitted; the outer base cup was a little longer than in I.

Mark III. is the cartridge described above, and approved on the 10/8/73.

Mark II. was found to cut, and is only issued to Enfield for proof; \* I. and III. are issued to the service.

Some experiments carried on in the R.L. have shown that the Martini cartridge does not resist wet as well as the Snider.

† All B.L. ammunition is proved at Woolwich by firing a per-centage Proof from a fixed mechanical rest, at a range of 500 yards. It is unnecessary here to describe the rest, its adjustment requires a skilled mechanic; at out stations sufficiently good results can be obtained by a good marksman firing from a sandbag rest. Care must be taken to use a rifle in perfectly good order. It is advisable to use several rifles, so that defects due to them may be eliminated.

The target is divided into squares by thick lines drawn at intervals of 3 feet, and into smaller squares by thin lines drawn at half a foot interval, and diagrams are drawn and divided so as to correspond to the target.‡ See plate, p. 337.

The rifle is laid on any desired spot on the target, and the rest once adjusted does not allow the rifle to shift; 20 rounds § are fired, and the position of each shot is marked on the diagram, the position of the point aimed at is also marked.

A point is selected from which to measure the distance of the hits (each hit is numbered in the order of firing), it is found convenient to select a point near to the group, but to the left of and below all the shots, this point is called the origin.

From this point the horizontal distance is measured and placed in the second column.

The vertical distance is measured and placed in the third column. Both columns are added up, and divided by 20 to get the co-ordinates of the point of mean impact.

This point is fixed by measuring the mean horizontal distance from the origin, and then measuring the mean vertical distance. Having thus marked the point of mean impact the distance of each hit from this point is measured by a scale corresponding to that of the diagram, and the distances are placed in the fourth column, and we thus get the deviation of each hit from the point of mean impact. This column is added up, and divided by 20 to get the average deviation from the point of mean impact, or as it is often called, the figure of merit.

Though ammunition at out stations should be examined and its shooting qualities ascertained, it is not to be condemned without the authority of the Surveyor-General. (See p. 277.)

Space does not admit of any detailed account of the advantages of the

\* Mark II. answered well in the rifles supplied to Woolwich for proof, but a little wider limits were allowed in the chamber of the rifles issued to the service, and the cartridge proved too weak.

† Much information will be found in "Military B.L. Rifles and Ammunition," by Captains Majendie and Browne.

‡ Half an inch to represent one foot will be found a convenient scale.

§ The first shot is not marked, as there is often a considerable difference between the first shot fired from a cold rifle and the subsequent shots.

Martini-Henry over the Snider.\* It has a flatter trajectory, greater accuracy, and penetration, and can be loaded much more rapidly.

The bullet is less deflected by the wind.

Gatling  
cartridges.

*Gatling Cartridge.*—This cartridge has been introduced for the Gatling gun, .45" bore;† it differs from the service cartridge in having a solid case, the base is formed by pressing out the material of the case, so as to form the projecting rim necessary for extraction. The charge and the bullet are the same as given for the Martini rifle, but the arrangement for the cap is different. No anvil is used; the cap is fired by striking against a raised part of the chamber.

Army Circular,  
June 1873,  
Clause 12.

The rule as to excluding B.L. S.A. cartridges from a gunpowder magazine should be rigidly attended to with this cartridge, as the cap composition is in close proximity to the raised part of the chamber, and seems to be more liable to accidental ignition than the cartridges for B.L. small arms.‡

Packing.

Ten rounds, packed heads and tails in brown paper.

A Gatling gun with a .65" bore has been tried, but no cartridges have been made for it in the R.L.

The limit of the effective range of the .45" bore is stated to be about 1,200 yards, after that the longitudinal error rapidly increases.—*Extracts, Vol., X., p. 51.* 100 shots fired at 3 rows of targets, 9' x 45', gave 91 hits at 1,000 yards, 76 hits at 1,200, 40 at 1,400, 22 at 1,600, and 13 at 1,800.

It is stated that the .65" bore cannot be used much beyond 2,000 yards without great waste of ammunition.—*Extracts, Vol. X., p. 256.*

\* *Extracts from B.L. Rifles and Ammunition, p. 39.*

At 500 yards range the greatest height of the Martini-Henry trajectory is 8.1 feet; at this range a cavalry soldier will be hit at any point, and an infantry soldier will be hit between 396 and 500 yards. The greatest height of the Snider trajectory at the same range is 11.9 feet; a cavalry soldier will be hit between 400 and 500 yards, and an infantry soldier between 438 and 500 yards.

The Martini penetrated 14½ elm planks ½ inch thick, as against 8½ with the Snider.

The Martini penetrated iron plates over ¼ an inch thick at 200 yards, the Snider failed to penetrate.

The figure of merit of the Snider is about 14", that of the Martini-Henry about 9". Under favourable circumstances the Martini has given as low a figure as 5.25".

Much information as to penetration will be found in *Extracts, Vol. VII, pp. 68, 231.*

† The service cartridge was tried but found not to answer.

‡ This cartridge could not be substituted for the Martini-Henry as the dimensions are different.

## CHAPTER XVI.—ROCKETS.

## HALE'S WAR ROCKETS, 9-PR. AND 24-PR.—SIGNAL ROCKETS.—LIFE SAVING ROCKETS.

The greater part of this chapter has been taken verbatim from Ammunition, Part II., by Captain C. O. Browne, late R.A.

## ROCKETS AND ROCKET MACHINES.

It is difficult to say at what date signal or sky rockets were first made, General and how far small rockets of this description were in old times discharged as projectiles.\*

Sir W. Congreve states that rockets of inconsiderable size had been used in India † for war purposes, and that General Desaguliers had attempted to manufacture large rockets in the Royal Laboratory, though without success, ‡ when in 1805 he (Sir W. Congreve) first formed the conception of a systematic construction of projectiles in the form of rockets.

The chief recommendation of such a system appeared to him to be “that projectile force was exerted without any reaction upon the point from which it was discharged,” † or, as he says elsewhere, “on its fulcrum.” §

Consequently, in rockets Sir W. Congreve saw the means of enabling boats' crews and individual men to discharge missiles of equivalent power to those projected by the heaviest cannon of the day. Thus he says, speaking of a rocket, || “it is ammunition without ordnance;” “it is the soul of artillery without the body.”

Commencing with the idea of an incendiary projectile which was to be suddenly thrown in large numbers from boats into a seaport town or a harbour crowded with shipping, ¶ he expanded the system so as to comprehend not only shells but also shrapnel, having for his object both the dispersion of bodies of men, especially cavalry, and the enfilading of trenches; work which he considered could be performed by rockets carried on horses by troops of the lightest description. The idea he

\* In “Mémoire sur les Fusées de Guerre, par Brussel de Brulard, Ancien Officier Supérieur d'Artillerie,” is quoted a statement made by Mailla in his “Histoire de China,” tome ix., p. 167, that the Chinese “used rockets and shells against the Tartars in the 13th century.” The same author states, pp. 2 and 3, that rockets were used in Europe in the 15th century. M. De Montgery, Capitaine, Chevalier de St. Louis, &c., makes a similar statement in his “Traité des Fusées de Guerre.”

† See a “Concise Account of the origin and progress of the Rocket System,” by Sir W. Congreve, p. 1; also conclusion to general view in the same work, p. 20; also same work, p. 14.

‡ Colonel Gerrard, then Adjutant-General of Indian army, states that he once saw three men killed and four desperately wounded by the same rocket, and states that the British suffered more from the enemy's rockets in the siege of Seringapatam in 1799 than from shells or any other weapon.

§ Tipu Saib undoubtedly taught us the value of rockets as a projectile. *Vide* Concise Account, postscript, p. 14; also Lectures by General Konstantinoff, p. 77.

¶ *Vide* Concise Account, p. 19.

§ “ ” ” p. 1.

¶ “ ” ” p. 7, and Lectures by General Konstantinoff, p. 78.

¶ An attack on Boulogne was his primary object.

had conceived so far became a reality that England obtained some of the advantages he had anticipated by the use of her new weapon.

On October 8th, 1806,\* 18 boats discharged 200 rockets into Boulogne and set fire to the town in many places without incurring the slightest opposition or suffering any loss.

At the battle of Copenhagen in 1807,† rockets fired into the town appear to have caused a considerable conflagration; a similar result was produced at Walcheren; and at Leipsic, in 1813, a troop of horse artillery vindicated Sir W. Congreve's opinion as to the possible value of rockets in the field. Lastly, they were successfully used at the river Plate and against the French boats on the Adour.‡

It may be well to consider more particularly, before proceeding further, the action of a rocket and the recommendations it possesses.

The cause of motion of a rocket has commonly been briefly described as being due to the difference of pressure on the head and base. Some, however, appear to speak of it as mainly the result of the pressure of the gas generated against the air "as a fulcrum";§ either explanation standing alone is very incomplete.

The following may therefore be added. The smallest quantity of gas generated must have a certain amount of inertia as well as tension, and the force which pushes it away from the point where it was generated must re-act on the rocket; the enormous rapidity at which such gas is formed and accumulates at once gives an atmosphere at a great tension, whether the action commenced in vacuo or in air, thus furnishing a fulcrum against which the nascent gas acts. The resistance of the air to the escaping gas, and also to the rocket, the cooling of the gas, friction, and other causes, further complicate the question.

Thus the rocket itself providing the necessary means of *propulsion*, it follows that means of *direction* only require to be supplied to fire it effectively, and these being very readily provided,|| rockets may be used in the various ways proposed by Sir W. Congreve.

To expose the surface of composition necessary to obtain the formation of a sufficient quantity of gas for effective propulsion, Sir W. Congreve made each rocket with a large conical hollow in the base.

The next point to consider is the size of the vents. The propelling power is proved to be inversely as the area of the vent,¶ but owing to the increased pressure in the interior of the rocket, the strength of the case of the latter must be inversely as the square of the area of the vent.\*\* (*Vide* Chapter on Congreve Rockets, by General Boxer.)

As an incendiary projectile the rocket possesses great recommendations, and its moral effect is very great, but it labours under certain disadvantages that hardly seem likely to be removed.

1st. Its efficiency and safety depend on the complete contact of a very large surface of composition with a thin metal case; hence it is liable to deteriorate from any great variations of temperature, causing expansion of metal; from chemical action causing corrosion; and from vibration

\* *Vide* Concise Account, p. 4.

† " " " p. 15; also Lectures by General Konstantinoff, p. 78.

‡ *Vide* MSS. notes on Gen. Gardner's course for school of gunnery; also Cust's Wars of the 19th century, vol. IV.

§ More frequently implied than distinctly stated.

|| By the use of tubes troughs, or by pointing the rocket in the required direction by resting it against a parapet or bank, or even on the ground, where it is to fire along a very level plain, for a sudden rise or broken piece of ground would divert its course, and might even turn it back on those who fired it.

¶ *Vide* General Boxer's Chapter on Rockets in Treatise on Artillery, pp. 68, 69.

\*\* *Vide* the same, p. 69. For a discussion of the form of vent, *vide* the same, p. 70.



in travelling ; any of these causes being liable to compromise the safety and efficiency of the rocket.

2nd. The gradual method by which its velocity is imparted to it entails the evil that its flight is very slow, and the rocket is consequently very susceptible to the action of gravity, wind, and accidental causes of deviation.

3rd. The same causes that thus make it peculiarly liable to be acted on by wind and gravity, aggravate the effect of deflection, for, unlike a projectile on which the force of the charge acts entirely in the *desired direction*, a rocket is continually developing velocity in the direction in which it is at the moment pointed ; thus, supposing it to be deflected one degree in the first second of time of flight, all the force next added will be applied one degree out of the proper direction, and so on with all impulses in succession ; indeed rockets have been occasionally deflected so as to come back, with very great and constantly increasing velocity, at the troops who fired them.

4th. In addition to the time afforded for the action of wind or other disturbing causes on a rocket, and also to its own further development of such deviation, Congreve rockets give a mechanical power to the deflecting action of wind from the lever afforded to it by the stick which they carry attached to them ; gravity also has increased power to alter the position of the axis of the rocket, and hence the direction of its impulses.\*

5th. From the fact of the composition burning away during flight, the position of the centre of gravity, and consequently the balance of the rocket, is constantly changing ; but this is a slight matter compared to those previously mentioned.

In the present day, when firing takes place at extended ranges, and great accuracy is generally requisite, the above objections are grievously felt, but they did not apply with so much force in the time of Sir W. Congreve.

The principle of motion being understood, it is necessary to pass on to the means by which a projectile of such length is kept point first.

Two methods have been employed :—

1st. The attachment of a stick, fixed on the base or side,† by which the centre of gravity is brought so near the point that pressure of the air acts on the stick end with sufficient leverage to keep the point always towards the direction from which such pressure proceeds ; thus on a still day the flight is tolerably direct, but on a windy day it is ever being deflected more and more up the wind, the action of the air being con-

\* Captain Browne remarks :—

To my mind there is a strong analogy between the relation borne by gun-shot to rockets, and that of statical to dynamical electricity. In the first-mentioned of each pair compared, the effect is produced by a *sudden impulse*, in the latter by a *constant force*. The former is in each case violent and little liable to be diverted from its course ; the latter acting gradually is subject to retardation, and has comparatively little power to force its path in a direct line. Hence the former is specially suited to destructive the latter to useful work ; thus, while lightning shivers the oak and the shot pierces the armour-clad vessel, the galvanic current carries messages round the world, and the life-saving rocket brings the line of communication to the stranded wreck.

† The stick was originally fixed to the side like those of signal rockets, but Sir W. Congreve altered its position to the centre of the base. It is obvious that a rocket with a stick on one side cannot have its "centre of resistance" opposite to its centre of gravity, and on the principle noticed with reference to shot so fired (*vide Appendix*, p. 208), the rocket would tend to describe a spiral path, the longer the stick the less would be the spiral ; hence there is a certain advantage in the very long sticks of signal rockets ; and the life-saving rocket, with its stick on one side, if fired without the line, carries very badly, as might be expected, for the above-mentioned reason. Also *vide General Boxer's Chapter on Rockets*, pp. 76, 77.



tinually to point it in the direction of the resultant of the resistance due to its present line of flight and the pressure of the wind. It is clear, theoretically, that such a tendency of the wind is insatiable, its action being directed to carry the rocket into a line of flight eventually approximating indefinitely closely to the "wind's eye."

Inaccurate as is this method of obtaining direction, it is peculiarly adapted to a projectile whose great length gives it enormous mechanical advantage if the weight is well forward.

The second method is that of rotation, imparted by some application of either the force of the gas escaping from the rocket, or of the resistance of the air; the great length of the rocket tells against the application of the rotatory system of direction, but the slowness of flight is in its favour.

It is unnecessary to dwell long on Sir W. Congreve's rockets. They were first made of paper and then of iron. It was he who established the system of naming a rocket according to its total weight;\* he seems never to have achieved success with the 300-pr. rockets† which he wished to make, but he dealt largely in 32-prs. With regard to his various projectiles, it should be noticed that the bullets of his shrapnel‡ were projected with a large bursting charge, with a much higher velocity than that of the rocket at the moment of fracture, for he obtained the advantage of keeping his bursting charge behind his bullets constantly.

§ 957. On the 14th September 1864, the well-known 24, 12, and 6 pr. Congreve rockets then in the service were provisionally superseded by a rocket of General Boxer's construction, patterns being sealed in August 1864, with the following improvements:—

1st. The Congreve rocket had the stick attached to a disc which closed up the end of the conical hollow, so that escape holes or vents (five in number) had to be made round it through the base of the composition; the latter was liable to give way on discharge and burst the rocket with the consequent sudden generation of gas; this fault was remedied in the Boxer rocket by slotting three vents in the disc opposite to the base of the conical hollow so as to leave the ring of composition unbroken and strong.

2nd. Greater accuracy was obtained by the employment of a stronger composition§ which caused the rocket to "jump" with a high velocity from its tube.

§ 1836. There were also minor improvements which need not be noticed. A pattern of Boxer 3-pr. rocket was provisionally approved, 1/10/66.

§ 1245. On 24/4/66, the use of war rockets as shells was discontinued.

§ 1469. In 1867 Hale's rockets superseded Boxer's improved Congreve rockets, Hale's 3, 6, and 12-pr. being approved on 25/7/67, and Hale's 24-pr. on 31/8/67. It seems necessary to enter into detail in describing these rockets.

An account of the Boxer rocket will be found in § 957.

\* *Vide Concise Account*, p. 7.

† M. de Montgéry says, in his *Traité des Fusées de Guerre*, that a Capt. Cox saw a rocket in course of manufacture in Burmah which was to contain 10,500 lbs. of powder. He refers to "Journal of a Residence in the Birman Empire," p. 192, published, London, 1821.

‡ I have called it "shrapnel" because in its action it more resembled this projectile than case, and the word "spherical case" being clearly incorrect, "Congreve or rocket shrapnel" seems the only designation for it. *Vide Concise Account*, pp. 10, 15; also general view in the same work, p. 7; and detail, p. 7.

§ General Boxer gives his reasons for the use of a stronger composition and the advantages so obtained in his chapter on rockets, *Treatise on Artillery*, pp. 71-76.

## HALE'S ROCKETS.

\* Calibres, 9 and 24-prs.

Hale's rockets,  
9 and 24-pr.

The main difficulties to be contended against in the manufacture of rockets, are the tendency of the case to break up under the heavy pressure of the gas, and the liability of the composition to deteriorate, owing to the tendency of the saltpetre to attack the iron of the case if it is in contact with the metal; the presence of moisture would accelerate this action.

When the metal is corroded by the saltpetre, a spongy porous deposit is formed between the metal and the composition; the result of this is that the flame finds an access to the whole surface of the composition wherever this spongy coating extends, and a large amount of gas is suddenly formed causing an enormous pressure, under which the rocket bursts explosively.

Mark I. rocket had a case made of wrought-iron, and the case was § 1469. greased inside.

These rockets were found to be unsafe, as the metal of the case was not strong enough, and they were also not properly protected from corrosion.† They were withdrawn in 1870. § 1881.

Mark II. and subsequent patterns of rockets are made of Atlas metal,‡ a mild steel produced by the Bessemer process; the Mark II. is however § 1679. imperfectly protected against corrosion, being only protected by blackening the cases and by greasing the inside.§

These rockets stood better than I., but are to be carefully watched, see § 1881. 3 per cent. are to be sent quarterly to Woolwich for examination from stations therein named, details will be found in the Changes of W.S. referred to.

Mark III. differs from II. only in having two coats of paint applied to the interior of the case (see p. 298); since the close of 1873, three § 1940. coats of paint have been given.

The case is formed into a cylinder, with edges lapped, riveted, and brazed with spelter (zinc and copper).||

The case is corrugated in three places to give a better hold to the composition, so as to prevent the case twisting away from it in flight (proposed by General Boxer).

The head is cast-iron, filled with oak, secured to the body by rivets.

The composition is separated from the head by a millboard disc, and from the base by a millboard washer. The composition (see table, p. 295) is pressed into pellets, and each pellet is introduced separately

\* 6 and 12-prs. were manufactured, but the manufacture was discontinued by § 1940.

† In manufacture all the cases are dipped in oil and blackened by holding them over a fire, this to some extent helps to resist rust, it is still carried out in all rockets.

‡ The metal is supplied in sheets of the required thickness; care is taken to cut the sheet so as to have the greatest strength of the fibre in a lateral direction, so as to resist the tendency of the rocket to burst.

§ This is of little use, as the first pellet pressed in carried down the grease with it.

|| Copper was tried in place of spelter, but the heat necessary to melt the copper injured the Bessemer metal.

into the case, where it is subjected to a higher pressure;\* subsequently a conical hole is bored out in the solid composition; the flight of the rocket depends on this hole, if the composition was left solid, gas would be generated too slowly on the rocket being fired to cause it to start.

The base of the case is closed by a cast-iron ring secured by screws, tapped to receive a tail-piece of cast-iron, containing three conical vents, the larger part of the cone being towards the interior of the rocket; the vents are cut away on one side, as shown in the cut; the



effect of this is that the gas issuing from the vent meets with a resistance on one side where the vent is prolonged, and there being no counterbalancing resistance where the vents are cut away, the rocket is caused to rotate.

The vents of the rockets are closed by attaching a thin piece of paper coated with shellac to the interior of the tail-piece.

§ 2211.

As the 9-pr. was found to "puff," a slower burning composition was introduced in 1872. Rockets with this composition are Mark IV.†

Extracts,  
vol. xi., p. 5.  
§ 2576.

It has been found an improvement to increase the length of the conical hole in the composition, and to form a cup-shaped recess in the interior of the tail-piece, this has been found to improve the range,‡ and to diminish the tendency of the rocket to "puff."

24-pr. rockets with the above improvements are Mark IV., and the 9-pr. will be Mark V.

In March 1874 the process of tinning the case of the rockets inside and out was adopted, the tinned case receiving the same coats of paints as detailed above. It is hoped that this may preserve the rockets from deteriorating by rust. The tinning will assist to close the seam of the rocket.

\* In each case the pressure is given by a hydraulic press; the pressure applied to the pellets in the 24-pr. rocket is about  $1\frac{3}{4}$  tons on the square inch.

† A Mark III. 9-pr. rocket burst within a few yards of the trough at practice at Shoeburyness. Mark IV. having a slower burning composition is safer.—Extracts, Vol. XI., p. 141.

‡ The mean ranges of five 24-pr. service rockets fired on board H.M.S. "Excellent" was 2,750 yards, that of four experimental rockets with the above given improvements was 3,175 yards; both were fired at  $15^\circ$  elevation. Some other experiments indicate that an increased range of about 300 yards may be expected from the improved rockets; 24-pr. III. fired at Shoeburyness gave a range of 3,901 yards, at an elevation of  $25^\circ$ ; the improved pattern gave a range of 4,271.

The dimensions of the Mark III. rockets are given below.

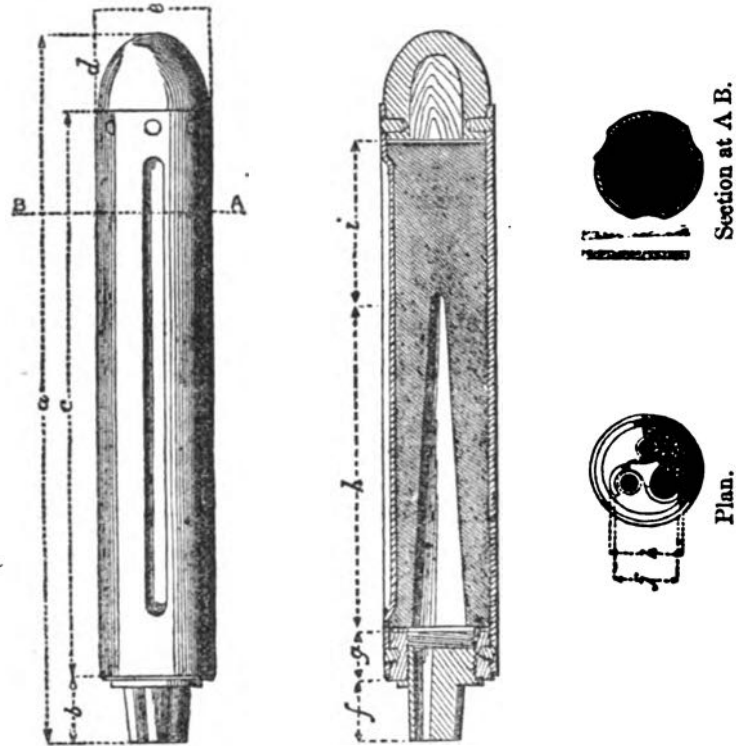

					9-pr.	24-pr.
<i>a</i>	-	-	-	-	16.25 ins. ± .025	23.18 ins. ± .025
<i>b</i>	-	-	-	-	1.56 in. ± .01	2.43 ins. ± .01
<i>c</i>	-	-	-	-	12.93 ins. ± .015	18.0 ins. ± .015
<i>d</i>	-	-	-	-	1.76 in. ± .02	2.75 ins. ± .02
<i>e</i>	-	-	-	-	2.5 ins. ± .01	3.75 ins. ± .01
<i>f</i>	-	-	-	-	1.48 in. ± .01	2.305 ins. ± .01
<i>g</i>	-	-	-	-	.8 in. ± .01	1.25 in. ± .01
<i>h</i>	-	-	-	-	7.6 ins.	11.875 ins.
<i>i</i>	-	-	-	-	3.85 ins.	3.813 ins.
<i>j</i>	-	-	-	-	1.4 in.	2.2 ins.
<i>k</i>	-	-	-	-	1.5 in.	2.4 ins.
Vents	{	No. of	-	-	3	3
diameter of		-	-	0.4 in.	0.625 ins.	

Extracts,  
vol. xi., p. 5.

The length of the cone in Mark IV., 24-pr., is 13", and in Mark V., 9-pr. [not yet settled].

The tail-piece is hollowed out .6" inches.

24-PR. ROCKET. MARK IV.

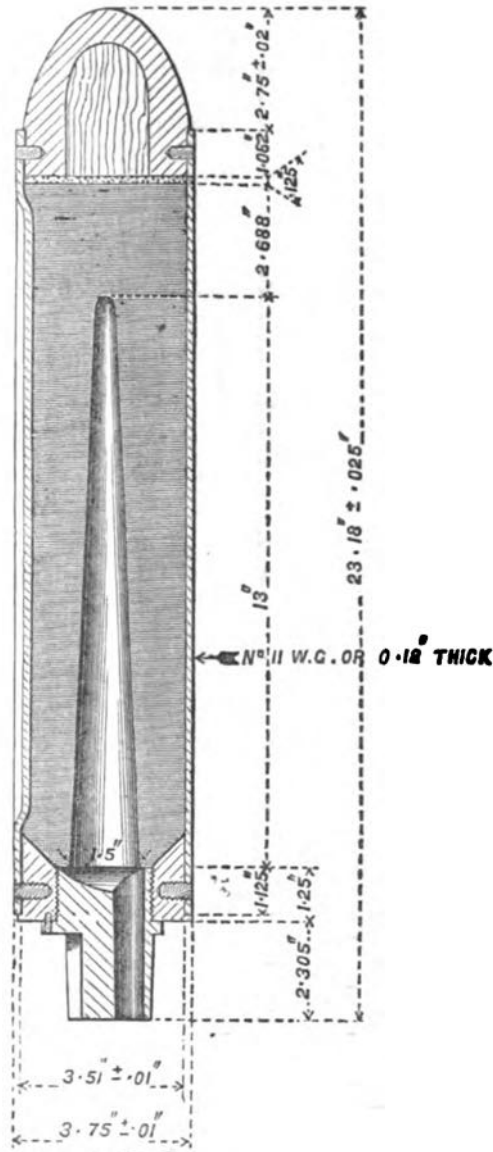

The following instructions have been issued as to examining, cleaning, and repainting rockets:—

Examining,  
cleaning, and  
repainting Hale  
rockets.

*Examination.*—All Hale rockets in store will, at frequent intervals, be examined carefully over the surface, and particularly along the seam and round the rivets, and those which show the slightest trace of rust or corrosion will be cleaned and repainted.

*Cleaning.*—The rockets will be placed in a convenient position for § 2441. scraping, that is, on a couple of rails laid on a table, or a similar arrangement, and the whole of the corroded parts well scraped with a copper knife or scraper, and then rubbed with emery cloth until every trace of rust or corrosion is thoroughly removed (if emery cloth is not available a piece of cloth or serge with fine dry sand will be used); the rockets will then be well washed or rubbed with a piece of serge steeped in spirits of turpentine, and afterwards wiped dry with old linen cloths.

*Repainting.*—A coat of paint will be put over the parts which have been so cleaned, and the rockets then laid to dry; when quite dry they will receive a second coat of paint, and after lying three or four days to become again thoroughly dry, they will be replaced in boxes.

The paint will be composed of the ingredients specified in table, p. 298. Five pounds will paint 100 rockets.

*Marking.*—Rockets when repainted will be re-marked with the original date, &c., as well as with the date and station where they have been repainted; a pencil marking on the red paint, or a piece of paper pasted on, will be sufficient for this purpose.

N.B.—Care must be taken during the above operations not to injure or break through the paper covering the inside of the vents.

The keeping qualities of rockets are not satisfactory.\* They should be stored in as dry a place as possible.

War rockets are withdrawn from the equipment of fortresses, and will only be employed with siege trains and in the field as circumstances may demand. Clause 129,  
Army circular,  
1872.

Rockets, as before pointed out, are very irregular, both as to range and direction.

\* Mr. Abel, chemist, W.D., gives his opinion as follows:—

“The corrosion of the metal at the seam of the case has not been set on foot in the first instance by the borax employed in brazing, as no trace of the existence of borax can be detected upon the metal at the joint. The saline matter scraped from the exterior of the case contains carbonate of potash.

“The deliquescent and alkaline nature of this salt accounts for the collection of moisture on the case and for the destruction of the paint coating.

“This carbonate of potash is a product of the decomposition of the saltpetre from the rocket composition, and it is owing to some imperfection in the brazing that small quantities of saltpetre have been admitted in the operations of pressing that a corrosive action has been established, which has been promoted by gradual access of air and moisture to those points, and by the co-existence of brass and iron in contact with the composition.

“The action of the saltpetre upon the metal appears to have spread in the interior of the case round that part where the brazing extends to a very slight degree, but sufficient to effect a separation between the composition and the case, which are found to be very firmly attached to each other at all other parts of the case.

“The slight symptoms of corrosion round the rivets at the head of the rocket are evidently due to the penetration of minute quantities of saltpetre (forced in by pressure) applied in manufacture to the exterior between the rivets and the holes; the non-existence of brazing at these points renders the action very trifling.

“The employment of brazing in the closing of the rocket cases is evidently a cause of deterioration; the existence of minute imperfections in the joint made by brazing is probably unavoidable, and as the saltpetre must penetrate on pressure, the establishment of corrosion is unavoidable.”



They are found to range longer when the wind is from right to left than when it is in a contrary direction.\*

#### EXPERIENCE AS TO FIRING HALE'S WAR ROCKETS.

Experience as to firing.

The average range of 25 24-pr., rockets fired successively in proof at Shoeburyness in 1868, with 15° elevation, was 1,895 yards, the maximum being 2,226 yards, and the minimum, which was exceptionally low, 1,546 yards, the average deviation being 49 yards.

The average of 77 24-pr. rockets fired successively in proof in 1870, at Shoeburyness was 1,460 yards, but the rockets ranged longer with the wind from right to left than from left to right, thus 51 rockets fired with the wind in the former direction had an average range of 1,678 yards, while 26 fired on days with the wind in an opposite direction, ranged only on an average 1,121 yards; the average deviation altogether is 35 yards.

#### RANGE OF ROCKETS FIRED IN PROOF IN 1873.

Range.

The average range of 18 24-pr. Mark III. rockets fired in proof in 1873, elevation 15°, was 1,562 yards, the average deviation was 39 yards.

The maximum range was 2,060, and the minimum 1,117 yards.

The average range of 30 9-pr. Mark IV. rockets, elevation 15°, was 1,536 yards, the average deviation was 38 yards.

The maximum range was 2,300, the minimum was 815 yards.

Rockets occasionally are found to "puff" in flight; this may be due to the sudden or irregular burning of the composition, or to the vents becoming choked; it is generally injurious to the flight of the rocket; the cupped-out tail-piece not being so liable to have the vents choked with slag, will, it is hoped, diminish the tendency to "puff."

Paint.

The rockets are painted on the exterior with two coats of red paint,† the mark or numeral is painted in black, and also the date of manufacture.

Marks.

The case near the head has A M (Atlas metal) stamped on it; both head and case have a letter and number stamped on them; the numbers run up to 1,000, and then the letter is changed.

On the base disc is stamped the numeral indicating the Mark, and also the date.

Issue.

Rockets are issued in wood cases, that for the 24-pr. holding 6, and that for the 9-pr. holding 12.‡

\* The rotation of a rocket is the same as that of a rifled projectile, from left to right; if a cylinder revolving in this direction is pressed on the right side there will be a tendency to run up, and the reverse if pressed on the other side, possibly this may account for the increased range of the rocket.

The times of burning are about the following :—

24-pr.	-	-	-	10 seconds.
9-pr.	-	-	-	8 seconds.

1515.  
1985.  
2441.

† At first Brunswick black was used as paint. Red lead paint was introduced in 1870, but complaints were received from foreign stations; the paint was found to come off, leaving the iron bare, therefore, in 1873, the ingredients were changed to those given in the table (p. 298).

‡ None of the Hale's rockets at present in the service have shells or incendiary composition in their heads, it is highly desirable that they should carry some means of igniting or destroying material.

Sir Samuel Baker, in a lecture on savage warfare, delivered at the U.S. Institution, points out that he would have found rockets much more serviceable if they had

## MACHINE OR TROUGH FOR HALE'S ROCKETS.\*

On 8/6/68 a trough machine was approved to fire 9-pr. Hale's § 1637 rockets, and on 10/7/68 a similar trough of larger dimensions was § 1651. approved for 24-pr.



The following general description applies to both :—

Each size consists of a sheet iron V trough ; the sides made at an angle of  $80^\circ$  with each other, supported at rear by three legs made of wrought-iron tubing, two short ones opening right and left, and one long one to the front beneath the trough, each terminating in a prong. On the front one runs a gun-metal ring connected by two bars with a V near the front of the trough, the bars pivot on V and ring ; the elevation is given by slipping the ring up and down the front leg, and clamping it with the arrow on the rear edge of the ring at the required line of graduation up to  $15^\circ$  of elevation for 9-pr., and  $25^\circ$  for 24-pr. machine, with reference to the plane on which the machine stands.

At the back end of the trough is an iron stop preventing the rocket sliding back ; it is slotted to form a crutch for copper friction tubes.

In firing the rocket with the friction tube in order to prevent the machine being disturbed, the lanyard must be pulled smartly or else the foot pressed against the leg of the machine, or again, the lanyard may be led under the foot.

---

carried incendiary composition, the rockets passed through native huts constructed of reeds without firing them ; even without shell he points out that he found them most serviceable in searching long grass where the natives used to be in ambush. Attempts are now being made to introduce a carcass rocket, and also rockets carrying gun cotton in their heads. Some satisfactory results have been obtained with 24-prs. carrying 3 lbs. of gun cotton, and also trials have been made of a rocket 6 inches in diameter, weighing about 100 lbs., carrying about 13 lbs. of damp gun cotton in the head, and having a fuze so arranged as to detonate the gun cotton with fulminate of mercury on impact. The detonation of such a quantity of gun cotton against buildings would be no doubt effective.

A range of about 3,000 yards has been obtained from the 6-inch rocket at  $20^\circ$  elevation.

For experience in Gold Coast expedition, *see* Appendix, p. 294.

\* Some machines were introduced which have become obsolete. *See* §§ 1488, 1528.

The general dimensions of the two sizes are as follows :—

	24-pr. Mark II.	9-pr. Mark II.
Weight of Machine	64½ lbs.	27 lbs.
Length of trough -	5' 6"	3' 5"
Width of sides -	4"	2½"
Paint.	Paint, black.	

*Issue.*

Issue. Each machine in a packing case.

SEA SERVICE ROCKET MACHINES.\*

§ 1805. On 7/6/69 a tube machine, Mark II., proposed by Lieut. Fisher, R.N.,  
§ 1860. was approved. It is described in Changes in War Stores, as follows :—

“The tube is attached at the centre by a vertically hinged joint to a small iron stanchion (see woodcut) which slips into a tabernacle† that can be fixed at pleasure to the stern, bows, or quarters of the boat ; in the stem a socket is fitted to receive the stanchion.

“To secure the tabernacle a keep pin is provided, and to prevent the stanchion unshipping from the tabernacle, a similar pin is attached to the heel of the stanchion.

“To prevent the heel of the tube turning into the boat (when firing) a clutch is provided, which does not allow of more than a few degrees of lateral motion. This clutch should be shipped when the bearing is roughly on.”

“The elevation is given by a straight bar marked in degrees attached to the tube, and worked through a slot in the stanchion. The friction tube lanyard reeves through a swivel block attached to the rocket tube immediately over the stanchion.

“When it is required to fire abeam or thereabouts, the stanchion should be shipped in the stem or stern according as the wind is from aft or forward, and when it is required to fire nearly ahead or astern, the stanchion should be shipped on the bow or quarter on the *lee* side.

§ 1860. \* A description of Mark I. tube machine, now obsolete, will be found in § 1432. An obsolete machine for Congreve and Boxer rockets is given in § 1270.

† “The word ‘tabernacle’ has been used for years to designate a short wooden stanchion having iron bands in which the wooden rocket stanchion was supported, the tabernacle itself being attached to the gunwale of the boat. Tabernacles were heretofore supplied by the dockyards, but it has been decided that in future supplies of the machine above described, the metal tabernacle (or socket into which the iron stanchion of the new fitment will fit) shall be supplied by the War Department.”

“The copper screw which was used with the rocket machine, pattern I., is not required for the above, and will therefore become obsolete.”

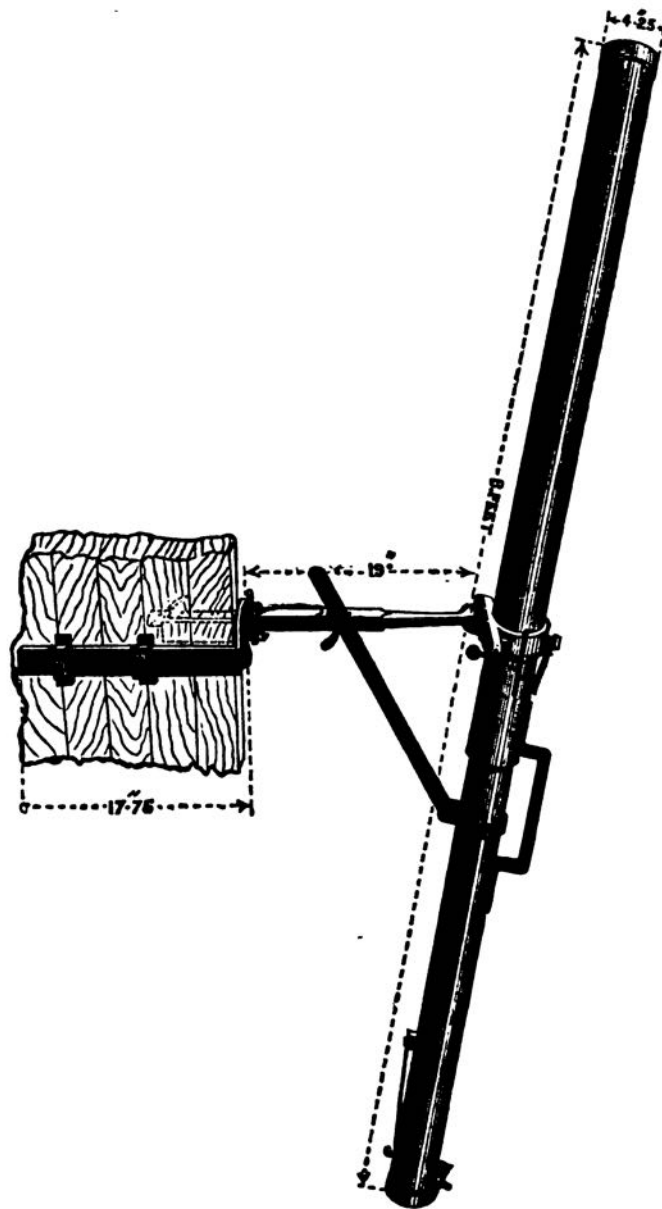

It may be observed that elevation (up to  $30^\circ$ ) with this tube is given with reference to the horizontal plane; that is on the supposition that the stanchion is at right angles to the keel of the boat, and that the latter is horizontal.

On 26/5/70 the following store was sealed for use with the above § 1931. machine, viz., a lanyard with block described in Changes in War Stores, as follows:—

“The arrangement consists of a lanyard rove through two small single blocks so as to form a tackle, to the moveable block of which is attached

a short lanyard with the hook for the friction tube. The fixed block through which the running end of the lanyard passes is attached to the rocket tube by a swivel immediately over the stanchion. The object is to give additional power so that a violent pull may not be necessary, which was the case with the former arrangement (§ 1805), the consequence being that the friction tube was frequently jerked out without igniting the rocket."

Paint. Black.

*Issue.*

Issue. Each machine in a packing case.

SIGNAL ROCKETS.

1 lb. and  $\frac{1}{2}$  lb.\*

§ 1709. The case is made of thick brown paper, rolled up into a cylinder, the rocket composition (*see* table, p. 295,) is driven by hand, and the conical hollow is made by a former placed in temporarily.

A light paper case is attached to the head, terminating in a cone, this serves to contain the stars and some mealed powder which serves to open the case and scatter the stars. The star chamber is separated from the rocket composition by some clay driven in at the top of the composition, having a central hole forming a communication; the rocket is choked near the base, and has a priming made up of L.G. powder and isinglas.† The vent is secured by a paper cap.

§ 2365.

The stick is attached by means of a copper socket, in Mark I. rocket the edge is fringed and slightly turned in so as to bite the stick. The stick occasionally became detached in flight, this has been remedied by having a small projecting piece at the top of the socket, and by cutting a notch in the stick, so that when the stick is fixed in the rocket the projecting piece can be bent down into the notch. Rockets and sticks with this alteration are Mark II.‡

Composition.

The composition is given on p. 295. The dogwood charcoal is used as it gives more sparks, making a brilliant tail to the rocket. The stars consist of small pellets of composition (*see* p. 296).||

Issue.

60 1-lb. rockets in No. 1 packing case.

84  $\frac{1}{2}$ -lb. „ in No. 4 packing case.

Marks and paint.

All signal rockets are painted stone colour, and are marked with the numeral and date in blue.

§ 1470.

Rockets issued since 20/7/67 have a label of directions pasted on their sides with the words "Before firing remove the paper cap over the vent of the rocket."§

§ 1516.

\* 2 lbs. and  $\frac{1}{2}$  lb. were made for Abyssinia, 19/11/67.

† This occasionally deteriorates while the rest of the rocket is in good order, it can easily be replaced.

§ 2333.

‡ A short stick with a rope tail is used for sea service. A Mark II. stick with rope tail has been sealed to suit Mark II. rockets.

The sticks for the 1 lb. and  $\frac{1}{2}$  lb. rocket are 8 ft. 2 ins. and 6 ft. 6 ins. long.

|| The 1 lb. rocket contains 28 stars and the  $\frac{1}{2}$  lb. 20 stars.

§ The signal rockets sent out to the Gold Coast deteriorated rapidly from the climate; special packing in tin lined cases seems desirable for such a service.

ROCKETS ISSUED TO THE BOARD OF TRADE FOR PURPOSES OF DISPLAY.  
(Sizes, 1 lb. and  $\frac{1}{2}$  lb.)

Owing to the danger involved in firing service signal rockets over the heads of crowds from the metal socket remaining on the rocket stick and causing it to fall swiftly, point first like an arrow, it was decided to make rockets for purposes of display on a different principle ; in these the entire case of the head is made of paper, including the socket to take the stick.\* In the small end of the latter (as in the case of the  $\frac{1}{2}$  lb. signal rocket) is a puff of powder communicating by a fire-hole with that part of the rocket composition which burns away just before the flame enters the head and bursts it open, consequently by means of this fire-hole the puff of powder is fired, and the stick ejected so as to float slowly in the air just before the rocket opens. The sticks are rectangular ; they are not tapered ; their lengths are 5 feet for the 1 lb. rocket, and 4 feet 2 inches for the  $\frac{1}{2}$  lb. rocket.

The 1 lb. and  $\frac{1}{2}$  lb. rockets are made of this description containing red and white, or red, blue, or green stars, the head being painted red, red and white, blue or green, according to the colour of the stars ; the 1 lb. contains in each case 50 stars ; the  $\frac{1}{2}$  lb. 28 ; the heads like that of the  $\frac{1}{2}$  lb. signal rocket are closed by choking. The puff of powder in the socket of the 1 lb. and  $\frac{1}{2}$  lb. rocket is  $\frac{3}{4}$  dram and  $\frac{1}{2}$  dram respectively.

The heads are in all cases opened like that of the  $\frac{1}{2}$  lb. signal rocket, by quickmatch packed in with the stars.

*Issue.*

In metal-lined cases and packing cases, sticks in bundles in numbers to **Issue** correspond to the numbers of rockets.

Signal rockets may be fired from a T frame with cleats, from off a **Machine rocket** nail in a post, or even with the stick end stuck into soft ground ; how- **signal.** ever, a signal rocket-tube machine, or "gun" for firing 1 lb. and  $\frac{1}{2}$  lb. signal rockets from boats, and under circumstances, when the back rush of flame might do injury, has long existed in the service, although no pattern was sealed and deposited until July 1866.

This machine consists of an oval tube of sheet iron ( $2\cdot8'' \times 2\cdot3''$ ) to take the rocket with the portion of the stick at its side, a round tube of sheet iron being fixed on to it to take the remainder of the stick in its interior.

The two tubes are joined together by being entered into the opposite ends of a middle piece of gun metal about  $6\cdot2''$  long, to which both are rivetted.

The larger part of the finished tube being about  $1' 8''$  and the smaller  $7' 6''$  long.

The metal at the mouth of the finished tube is wire edged, at the opposite end is a ground spike.

A vent is made in the closed portion of the base of the oval tube opposite to the vent of the rocket to take a quill tube for firing, which is prevented from falling out when the tube machine is pointed up into the air, by a hinged piece of gun metal which shuts in behind its head.

---

\* The sticks for Board of Trade rockets are much shorter than those for signal rockets of larger size ; the gain in both convenience and strength is great.



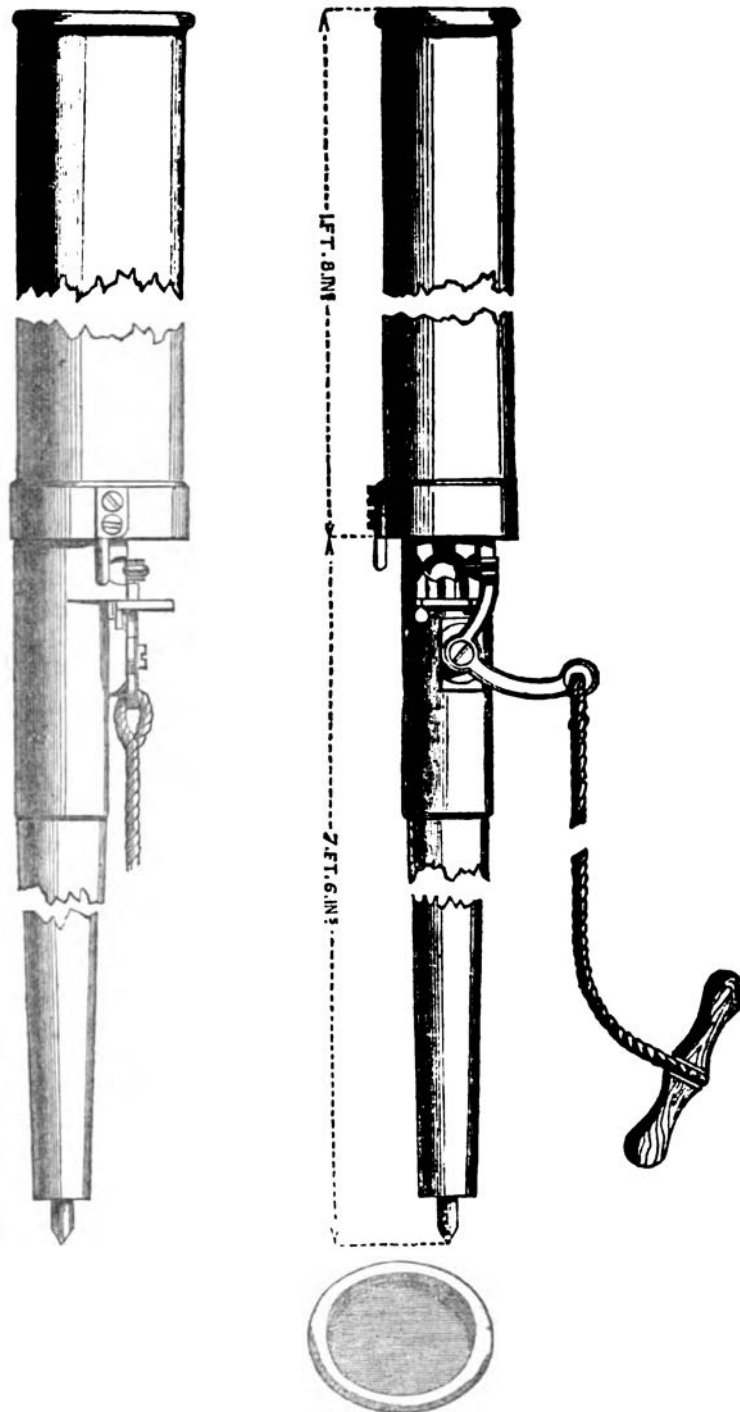

In Mark I. machine the detonating cross-headed tube was used, which was fired by the blow on the side of its head given by a hammer worked on a hinge and made to descend by the pull of a lanyard, in a manner very similar to the hammer formerly fixed on guns fired by detonating cross-headed tubes.

§ 1373.

On quill-friction tubes entirely superseding the above, a pattern of this machine was sealed and approved as Mark II. (3/11/66), which differs from Mark I. in having a hook fixed on to the end of a bell-crank

lever, which is worked by lanyard and toggle so as to fire the quill-friction tube, the form of the gun-metal hinged support being altered to suit the dimensions of the tube.

#### Issue.

Sixteen rockets in a packing case, or when specially demanded, 18 in Issue. a box fitted with lock and key.

#### QUICKMATCH LEADER FOR FIRING ROCKETS.

On 8/9/68 a pattern rocket leader, Mark I., was approved, consisting § 1675. of "10 short pieces of quickmatch, about 4 inches in length, attached at "intervals of 3 feet to a piece of match 31 feet long."

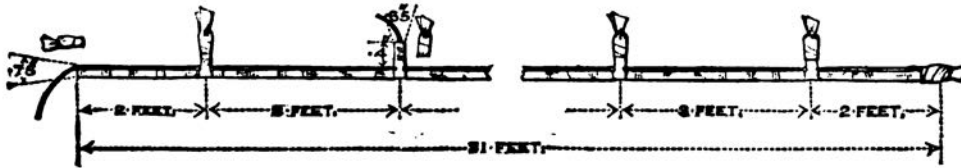

On 22/5/69, a pattern rocket leader was approved; it differs from the § 1793. last-mentioned pattern in having "nine short pieces instead of 10 at "intervals of 3 feet; it is 34 feet in length, and has 5 feet of leader "clear at each end." None of the previous pattern having been issued, this store is also marked I.

#### LIFE-SAVING ROCKET, BOXER, 12-PR.\*

The life-saving rocket.

Dennet's "twin" rockets were superseded by Boxer's on 15/3/65. This consists of two rocket bodies, one being fixed in prolongation of the other, to give great length of burning and flight without any sudden violence which might break the line which it carries,† or irregularity from uneven burning. Life-saving rocket, Boxer, 12-pr. § 1047.

Thus it will be seen that "instead of making one cavity in the rocket "two cavities (*c c'*) are formed, the one behind the other, with a portion "of solid composition (*b*) between them, so that when the solid composition (*b*) is burnt through, the front cavity (*c'*) is ignited, thereby "imparting to the rocket an additional impulse." The stick (*d d*) is fixed at the side of the rocket. The line (*e e*) is passed through a hollow at each end of the stick, as shown in the annexed cut, and the end of the line is secured by a common overhand knot; 2 india-rubber, and

\* Time of burning, about  $4\frac{1}{2}$  seconds.

† General Boxer writes in letter of 25/5/65 that his object is "the continuance of "the propulsion through a much longer period, without any excessive strain upon the "line."

Captain Robertson, R.N., writes to Secretary, Marine Department, Board of Trade, 9/2/65, that Dennet's rockets "frequently carry away the lines, and sometimes do not "ignite. They are also double the expense" of Boxer's rocket.

Inspecting Commander Earle reports on a trial between Boxer's and Dennet's rockets,— "Of the three double Dennet's rockets only one was any use; two broke "their lines and struck the ground. . . . The mean of the five shots with the "Boxer rocket gave a range of 370 yards very true, and with much less strain on the "line, as it never broke with Boxer's rocket."

Reports from Inspecting Commanders Charles and James, from Yarmouth and Lydd, are confirmatory of this statement, 19/10/65.

At Whitby, on 27/3/66, one of Dennet's rockets, igniting before its twin rocket, came back and struck the Inspecting Commander.

Captain Robertson, in letter 9/2/65, reports that Dennet's rocket attained a greater range than Boxer's.

1 brass washer (f) are placed between the knot and the stick to reduce the effect of the sudden jerk which is given to the line when the rocket is fired. The arrangements for the use of this rocket are the same as those hitherto carried out with Dennet's rockets.

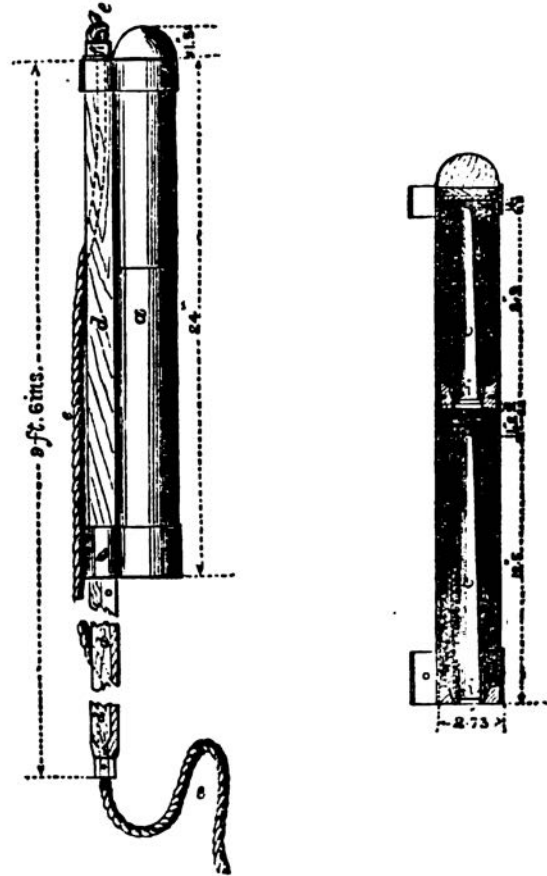

A second knot is usually made in the rope near the hinder end of the stick, in case the line should be burnt through by the flame issuing from the rocket.

N.B.—All Boxer life-saving rocket cases are protected from the action of the composition by an internal coat of anti-corrosive paint, consisting of—

§ 2441.

Copal varnish -	$\frac{1}{4}$ pint.	Turpentine	-	$1\frac{1}{4}$ pints.
Gold size	- 1 „	White lead (dry)	-	7 lbs.

being the same as is now applied to the interior of Hale's rockets.

All rockets manufactured since 22/9/68 have their cases further protected by blackening by burnt oil.

### BOXER'S LIFE-SAVING ROCKETS.

#### DETAILS OF PATTERNS.

§ 1047.

The pattern in the woodcut known as Mark I. was approved 15/3/65. Mark II., approved 9/66,\* differs from Mark I. in having no hole to take the keep-pin through the "clip," the pin being passed through the stick in front of the clip, because it was sometimes found troublesome to bring the hole in the stick and "clip" exactly to cover one another.† The

\* Not noticed in Changes in War Stores.

† Vide letter by Inspecting Commander Kirby, Sunderland, 28/10/70.

sealed pattern is nearly  $\cdot 5$  inch shorter than Mark I., so as to enable the rockets manufactured to conform with it, it having been found that the act of pressing the composition slightly shortens the whole case; hence that of the dummy pattern was longer than the same case would be after pressing.\* Mark III.,† approved 1/9/68, differs from Mark II. § 1679. in having the case made of Atlas (*i.e.*, Bessemer) metal. All manufactured since October 1870 have the vent covered with paper (instead of the serge plug). The paper is to be broken before firing. § 1995.

It is important to distinguish pattern III. clearly from I. and II., the cases of rockets of the latter pattern having been found liable to deteriorate, and even to split, from their being taxed beyond their strength by the pressure of the composition, are ordered to be very carefully examined from time to time for rust spots and indications of cracks‡ (*vide* p. 231). § 2441.

Paint: formerly two coats of black varnish; since 5/11/70, two coats of red paint for better protection (*see* p. 298). § 1985.

The 12-pr. life-saving rocket stick§ is deal, 9' 6" long, square, with corners shaved off; it is the same size from end to end. It is bound at the bottom end with an iron ring, and is plated at the head or front end with plates, which, as well as the stick at the front part, are hollowed to fit close to the rocket. The second or hinder plate is three inches long; it has a flange to rest against the base clip of the rocket. Over the half of the stick next the rocket is tacked a sheet of tinned iron for a length of 14 inches, to protect the stick from the flame escaping from the rocket.

#### *Iron Pin for Life-saving Rocket, Mark I.*

This is an iron pin 1' 2" long, No. 8, Birmingham wire gauge; the end is bent over at a right angle, thus bringing the length down to  $\cdot 85$ ". § 1271.

#### *Brass Washer.*

The brass washer shown in the woodcut of the rocket (p. 240) is 1" in diameter, with a hole in the centre  $\cdot 5$ " diameter; it is  $\cdot 15$ " thick.

#### *India-rubber Washer.*

The vulcanized india-rubber washers referred to in the description of the rocket are both alike, each being 1" in diameter, with a hole in the centre  $\cdot 5$ " in diameter; they are about  $\cdot 7$ " thick.

#### MACHINE FOR FIRING LIFE-SAVING ROCKET.

The machine for firing the life-saving rocket consists of a bed to hold the rocket, in prolongation of which is fixed a pry pole, and from the rear end of which spring two legs, one opening to the right and one to the left. Both bed and pry-pole are made of sheet iron, the former being an open rectangular trough 3' 2 inches broad || and 4 inches deep; || the latter one, of more rounded form, being 1' 65 inches broad || at the top and 1' 5 inches deep.||

\* To prevent mistakes arising from comparing an empty pattern with a filled rocket.

† The numeral marked on the pattern sealed as II. was altered in place of sealing a new pattern.

‡ The crack is generally developed in a longitudinal line running parallel to and within one or two inches of the seam or joint of the rocket.

§ Mark III. stick is strengthened by having the part next the base of the rocket more covered by the tin sheet, which is also passed under and clamped by the iron socket. § 2385.

|| Interior measurement.

The front end of the pry pole enters the bed for a length of 7 inches, the upper edges of the former standing about  $\cdot 2$  inch above those of the latter, so that the bottom of the larger trough is  $2\cdot 7$  inches beneath that of the smaller, to allow for the rocket resting in the bed while the stick lies in the hollow of the pry pole. The two troughs are fixed together by three rivets on each side, the spaces between them on each side, owing to their difference of width, being filled up by a piece of wrought iron through which the rivets pass.

The front edge of the bed trough is iron-strapped, and its remaining edges, as well as those of the pry pole trough, are "wire-edged." With the exception of a strengthening bar running from bed to pry pole the rear end of the bed trough is left open beneath the front of the pry pole, so as to allow of a free passage to the gas escaping from the rocket base.

Two pieces of wrought iron 7 inches long are riveted along the after part of the sides of the bed, close to the angles formed with the bottom, their rear ends projecting sufficiently to allow of a bolt secured with a screw washer to pass through them, on which hinges a small flat piece of iron taking two other bolts screwed and nutted, and each long enough to allow of a socket (ending in flanges) which admit the flat iron between them to be hinged on it. Thus the flat iron hinges longitudinally on a bolt transverse to the direction of the troughs; whilst the leg sockets move transversely on hinges longitudinally placed. In each socket is fixed an ash leg with ferrule, having a foot projection and spike; while beneath the pry pole runs a strengthening bar from end to end, which is at the hinder extremity bent down to form a ground spike.

In the right side of the bed is cut an opening to admit of the entrance of a portfire to fire the rocket, and behind this is fixed a brass quadrant plate, on which is hung a plummet and line to give elevation.

On the left side of the bed, protected by a copper cover, is a strong lock of simple construction, with a lever trigger, to which is attached a line, led through one sheave on the left leg socket, and another near the left foot. Near the right foot is fixed by two screws, a strong strap and buckle to enable the two legs and pry pole to be strapped together, for more convenient stowage when not in use.

Mark I. trough or machine has long existed; it was sealed in November 1865.\* This pattern has a very small block fixed to a ring near its left foot. It is difficult to pull the trigger line from the right side, owing to the stiff movement of the little block.

Mark II. was approved 21/10/70; it differs from Mark I. as follows:—

1st. The trigger lever is prolonged to a length of about 4 inches, so as to allow of the lock being worked with a lighter pull.

2nd. The pulley block on the left foot is replaced by a sheave of much larger size fixed through the middle of the wood (which is supported by a band); this pulley enables the machine to be fired from the right side.

3rd. The opening in the right side of the trough is furnished with a sliding cover.

§ 2385. Mark III. machine differs from the previous pattern only in having an arrangement for causing the flash from the detonating tube to strike direct up the axis of the rocket. This is effected by making the vent or channel for the tube in a circular form instead of straight across the machine.

N.B.—A spare spring is ordered to be supplied.

§ 1911. A priming wire for life-saving rocket machine was approved on 20/5/70, and a pattern, Mark I., sealed.\* It is formed from iron wire No. 5 Birmingham gauge. It is about 4 inches long, being formed into

\* Not mentioned in Changes in War Stores.

a loop at one end. On 21/10/70 a pattern, Mark II., was approved, § 1995. differing from Mark I. in being twisted to form a screw at the part near the point. On 4/9/72, Mark III. was approved; it is curved to fit the vent in Mark III. machine. § 2385.

It is used to clear the vent of the life-saving rocket machine of any Use. portions of the quill tube that may remain in it after firing.

#### LIFE-SAVING ROCKET TUBE.

The life-saving rocket tube consists of a goose quill body about  $1\frac{1}{2}$ " in length, driven and pierced in the usual way.

The large end of the quill is closed by a disc of tissue paper being varnished over it.

Into the smaller end of the quill is secured with diamond cement a pigeon quill about an inch long, which enters the large tube to a depth of about .1 inch.

This tube is filled with detonating composition, *see* p. 296.

Round the extreme small end runs a small band of kamptulicon.

These tubes are used for firing life-saving rockets. The body of the tube is inserted into the vent of the lock at the side of the machine, being held in its place by a small piece of brass which shuts on its neck just below the kamptulicon band. The descent of a spring hammer edge crushes the detonating end of the tube and fires the same.

They are packed, by the special request of the Board of Trade, in larger quantities than other tubes, viz., 150 in a (No. 27) tin cylinder, which is closed by a calico band attached by shellac over the junction of lid and body. Packing and issue.

#### FUZE FOR LIFE-SAVING ROCKET, MARK I.

This is 1.5" long; it is made of paper; it contains an inch of ordinary fuze composition; it is conical in shape, and the sides are covered with kamptulicon, being brought up to fit the vent in the base of the life-saving rocket; it has a paper cap tied on with twine, which need not be removed before firing; it burns for about five seconds, and is required for use with the portfire.

#### STORES CONNECTED WITH THE LIFE-SAVING ROCKET.

*"Light, Long, General Service" (Mark I).* *See* p. 79.

This light has been in use in connexion with the life-saving rocket, § 1047. having been approved for that purpose on 15/3/65. It came in for § 1721. general service in 18/3/68; but it is issued and used with a hollow metal handle in connexion with the life-saving apparatus, but for land § 1726. service with a wooden handle, approved 5/12/68.

This light was found not to burn sufficiently long, therefore the "light, illuminating wreck," given on p. 79, is now issued. March 1874.

#### *Portfire, Boxer's, for Life-saving Apparatus.*

Differs from a common portfire in being 8 inches long, and in being intended to ignite by means of a detonating primer, in the same way as the long G.S. light, the end being closed by a tin cup and a piece of kamptulicon, and strengthened by a tin band, perforated to take the detonating primer, which enters into a small space beneath the kamptulicon. The composition is primed in the usual method with mealed powder, perforated in the centre.



*Metal Handle for Long Light, General Service (Mark I.), used with Life-saving Apparatus, Mark I.*

§ 1271.

Consists of a hollow cylinder of tinned iron, fitting on to a wood end ; it is closed at the opposite end by a metal screw cap, to which is hinged on, by means of a brass pin passing through two brass flanges so as to form a hinge, a copper covered piece of wood, with six transverse cells, each to hold one primer.

*Handle for Portfire used with Life-saving Apparatus, Mark I.*

Consists of a tinned iron cylinder, closed across with tin and red lacquer, so as to form a socket to take the portfire end at one extremity held by a tightening screw. The body is hollow, closed with screw cap and piece of wood copper covered and recessed with seven cells to take one detonating primer each.

*Tin Box for Life-saving Rocket Stores, Mark II.*

This is simply a tin box with a hinged lid.

Length	-	-	-	-	6'1
Breadth	-	-	-	-	3'6
Depth	-	-	-	-	3'0

On the lid is a label giving the contents, viz. :—

- 9 fuzes.
- 9 detonating tubes.
- 9 iron pins.
- 12 india-rubber washers.
- 6 brass washers.

*Wood Boxes for Lights, &c. for Life-saving Apparatus, Mark I.*

These are two yellow deal boxes closed with hinged lids secured with hasps and staples ; they have internal fittings to suit the stores.

The large one is 13·3" × 8·4" × 11·5" ;\*

The smaller is 12·2" × 6·2" × 11·5"

(the depth of both being the same).

Their contents are as follows :—

	Large Box.	Small Box.
Lights, long	10	6
Portfires	12	6
Handles, light	2	1
"    portfire	2	1
Detonating primers for lights	12	7
"    "    for portfires	14	7

USE OF LIFE-SAVING ROCKET.

Instructions as to the use of the rocket, together with directions as to the formation of volunteer life brigades, the provision of requisite stores, &c. are issued by the Board of Trade, in the form of a pamphlet, entitled "Instructions in respect of the Rocket and Mortar Apparatus for saving Life from Shipwreck." A short description of the method of using the life-saving apparatus generally adopted is here given, taken partly from this pamphlet and partly from information supplied by Captain Robertson, R.N., also Mr. John Foster Spence, Mr. Gilbert, and members of the Tynemouth Volunteer Life Brigade.

\* External dimensions.

A suitable cart containing the necessary stores\* is run down to the best position for action.†

\* (b.) "Two or three *rocket lines* laid up loose. One end of the rocket line is to be attached to and launched with the rocket.

(c.) "Boxes fitted with faking pins, in which to stow the rocket lines.

(d.) "A '*hawser*' of 3-inch Manilla right-handed rope, from 40 to 120 fathoms, according to the steepness or flatness of the shore.

(e.) "A '*whip*' of Manilla line, not exceeding 1½ inches, rove through a single tailed block. The '*whip*' to be made of left-handed rope, the reverse of the hawser, and to be twice as long as the hawser, and the tail of the block to be at least 2 fathoms in length, and the sheave to be brass-bushed. The ends of the '*whip*' to be spliced together, so as to convert it into an endless rope.

(f.) "A '*sling life buoy*,' with petticoat breeches, in which to place the person to be rescued, and haul him ashore.

(g.) "A '*traveller*,' or inverted block, with a brass sheave, to be attached to the '*sling*,' and carry it along the '*hawser*.'

(h.) "A '*double block tackle purchase*,' for setting taut the hawser, one of the blocks being fitted with two tails to bend on to the hawser, or with luff tackles fitted to put on to the hawser with strop and toggle (like a top-gallant or royal purchase). The blocks to be brass-bushed.

(i.) "Three small *spars* to form a triangle, over which the hawser may be passed and thereby raised higher above the water. This will be found convenient on parts of the coast where the shore is flat.

"The triangle should be fitted with a swivel snatch block, brass-bushed, instead of standing hooks; the strapping of the block to be of good iron.

(k.) "An '*anchor*' with one fluke, to be buried in the earth, sand, or shingle, to which to set up the hawser by means of the tackle purchase. Or in some places where the shore is composed of soft shingle or sand, and where an anchor will not hold, a stout plank, 5 or 6 feet long, with a fathom of chain of sufficient strength fastened around it amidships, may be substituted for the anchor. This plank being buried three or four feet beneath the ground, and the end of the chain, with a ring attached, led to the surface, the hawser may be set up to it, by the tackle purchase, in the same manner as to an anchor.

(l.) "A '*red flag*,' 2 feet by 3 feet, fixed at the end of a staff 5 feet long; and a '*lanthorn*,' with a red lens fixed in it; to be used as signals in the manner directed below.

(m.) "Two or three *spades* or *shovels*, and a *pickaxe*, to be of good quality and suitable for the work; a *salvagee strop*, and a few pieces of *extra rope* to be used as occasion may require.

(n.) "A light *hand-barrow*, when thought necessary, for carrying portions of the apparatus from the cart to the place where it is to be used.

(o.) "Three sets of *tally boards*, each set consisting of two boards of hard wood about 9 inches long, by 5 inches wide, and ¾-inch thick. These boards to have the following words painted on them in white letters on a black ground. English on one side and French the other; viz.:—

"No. 1 tally board to be attached to the whip.

"English:—

"Make the tail of the block fast to the lower mast well up. If the masts are gone, then to the best place you can find. Cast off rocket line, see that the rope in the block runs free, and show signal to the shore.

"French:—

"Fouettez la poulie le plus haut possible sur le bas-mât, ou à l'endroit le plus favorable si les bas-mâts sont perdus. Détachez la ligne, voyez que la corde coure facilement dans la poulie, et faites signal au rivage.

"No. 2 tally board to be attached to the hawser.

"English:—

"Make this hawser fast about 2 feet above the tail block. See all clear and that the rope in the block runs free, and show signal to the shore.

"French:—

"Amarrez cette aussière a deux pieds environ au dessus de la poulie. Voyez que rien n'engage et que la corde coure facilement dans la poulie, puis faites signal au rivage.

(p.) "Long light. One box of Colonel Boxer's, to be used as occasion may require.

(q.) "Signal rockets. Eighteen, throwing white and red stars.

(r.) "Two *heaving sticks* and lines, to be used as occasion may require.

[Continued on p. 246.]

† As the rocket cannot under any circumstances be expected to carry much over 380 yards (vide pp. 249 to 252), the choice of position must generally be very limited,

The machine is placed to stand as firmly as circumstances will permit, for a maximum range the trough should be laid at from  $35^{\circ}$  to  $38^{\circ}$ ,\* the box in which the line is faked being placed from about 6 to 9 feet to the rear, and 6 to 9 feet to leeward,† the top with the pins being taken out and the box slightly tilted with its mouth towards the front with the line lying in it, the end being threaded through the rocket stick and knotted over the washers and also some way along the stick,‡ the lanyard by which the rocket is fired should be pulled by a man standing on the windward side,§ the rocket being fired, if possible, by the tube (without the fuze)|| in order that it may be discharged the instant a favourable opportunity is presented, which opportunity might pass while the fuze is burning.

It is very important, for more than one reason, to effect a communication with as few unsuccessful attempts as possible, not only is precious time wasted, but after the line becomes dirty and wet the chances of success are decreased.

At short ranges it may be desirable to fire the rocket at a lower elevation than  $35^{\circ}$ , for it is easier to project the rocket between the masts, when the line must of course follow it, than to fire it high in the air with the allowance necessary to cause the line to fall between the masts.¶

When the crew of the wreck signal that they have the line,\*\* the rocket brigade make fast their "whip" (e in note, p. 245) by bending the rocket line round both returns at about 12 feet from the tailed block and signal.††

The wreck's crew then haul in and make fast the tail of the block about 18 inches below the highest secure part of the ship,‡‡ (some distance up the mast if possible,)§§ unbend the rocket line and signal.

(s.) "A water burrico, with a large square hinge bung large enough to admit a man's hand, will be supplied if specially demanded.

(t.) "A hawser cutter, for the purpose of severing a hawser from a wreck.

(u.) "A tarpaulin, to cover over the apparatus and stores in the cart when the apparatus is not in use, and fitted with beackets and tent pegs, to secure it on the beach or shore for coiling the whip on when the apparatus is in use.

(v.) "Life belts. Two of Captain Ward's, and two life lines.

N.B.—"The whole of the gear and a sufficient supply of rockets, &c. are to be kept in the rocket apparatus cart, IN GOOD ORDER, DRY AND READY FOR IMMEDIATE USE."

\* *Vide* Board of Trade Instructions, § 19.

† The rocket stand may be capsized by the line running out if the line be laid to windward; the coil should be as little out of the line of flight as may be, for it is obvious that the pulling of the line tends to draw the axis of the rocket in the direction of a line passing from the centre of gravity of the rocket to the spot where the rope is coiled. That the position of the coil of rope affected the flight of the rocket considerably was pointed out by Captain Alderson in a proof report on rockets fired at Shoeburyness.

‡ *Vide* page 191.

§ To be clear of the line as it runs out.

|| The slide lid in Mark II. machine over the opening on the right side used for the admission of a portfire is to be kept closed. Should the tube be found weak, a few strands of quick match may be doubled and inserted so as to project from the vent of the rocket.

¶ Even at  $35^{\circ}$  I believe the rocket generally passes between masts. As to flight of rockets, *vide* page 249.

\*\* Either by a wave of hand or flag, a light shown, or a gun fired.

†† Generally by red flag by day, and red light by night, *vide* Board of Trade directions.

‡‡ There are many reasons for this, 1st. The hawser will bend with the weight of any person travelling on it, and perhaps let them into the water. 2nd. If near the water the wash of the sea may twist and foul the ropes. 3rd. The higher the starting point the easier it is to haul a weight to the shore.

§§ I have been informed of an instance of a whole crew being drowned by making fast to the knightheads on the deck instead of some point up the mast. I may observe that a brother of my own in travelling experimentally on a low hawser descended into the sea, but it is hardly necessary to enunciate that there is a limit to the distance which a person can be drawn through the surf without drowning.







While the crew are drawing this "whip" in, it is especially necessary that the brigade on shore should see that the lines are carefully paid out to them, keeping the two parts steadily in hand, at the same time not letting them out faster than the crew on board the wreck can haul in, the men who have charge of the two coils of the whip being specially careful that the lines run out all clear from the coils.

On seeing the ship's signal the brigade attach the hawser 6 or 9 feet from its end to one return of the whip and haul on the other return, so as to carry the hawser to the ship, which the crew make fast 18 inches above the whip (*i.e.*, to the highest safe point), and then disconnect it from the whip and "signal." While those on shore are hauling the hawser on board the ship it is especially necessary that the men in charge of the whip should keep the returns of the opposite end, if possible, 30 yards or more apart, and the hawser nearest to the hauling part, to prevent the hawser taking turns round the whip, which is very liable to occur even when these precautions are observed, and the wrecked crew should, if possible, ascertain before making the hawser fast that it is all clear.

On this, the brigade having adjusted the block of the breeches buoy to run on the hawser, attach one return of the whip line to it by a clove hitch, and if the motion of the wreck is slight, lead the hawser through the snatch block of the triangle and set it up (*i.e.*, haul it taut) by means of their "double block tackle purchase" (*h* in note, page 245). This, however, can be paid out or hauled in but slowly if required to follow the motion of the vessel. If, therefore, the sea beats the wreck about violently it will be better not to use the double block tackle, but to keep the hawser taut by manning it with as many hands as can be spared so as to follow the oscillating motion of the wreck without risk of the communication being broken.

It will be seen in the woodcut that while the whip return by which the buoy is hauled towards shore must be pulled fair along the hawser, the opposite return should throughout be kept wide of it.

The crew may descend, one, two, or even three at a time in the breeches buoy.\*

In cases of very violent wind the empty breeches buoy has been carried right round over the top of the hawser,† fouling the whip with it; it is therefore well not to let it pause while on a journey, especially when travelling empty back to the wreck.

In urgent cases, such as the threatened immediate break up of the wreck, one or more buoys with lines to them communicating with the shore may be passed to the wreck directly the whip is made fast, or again, the "buoy" may be made fast to one return of the endless line while it travels on the other,‡ at the same time the hawser should be set up when practicable.§

\* For the quickest rate at which this may be done *vide* note, p. 249.'

† Capt. Robertson informs me this has been reported as having occurred.

‡ The endless line must be cut to effect this; it is best to make fast the ends to the grummets on opposite sides of the life buoy.

§ Various methods of escape from a wreck have been devised and some carried out; the crew are generally in a nearly helpless condition with the waves beating over them, the most feasible expedient appears to me to be that of a kite, as there is generally a violent wind blowing from the wreck to the shore, and considering the comparative sizes of the ship and the land it seems reasonable (as proposed by Capt. Nares, R.N., *vide* "Seamanship" by that officer, pp. 220 to 222) to call attention to the possibility of the crew making and getting off a kite when the means on land were insufficient to establish a communication. Once let the kite fly

[cont.]

## FLIGHT OF LIFE-SAVING ROCKET.

It may be seen that the construction of the life-saving rocket is not such as will enable it to carry truly when fired without its rope. Its stick is fixed on one side of it, hence in flight the resultant of the resistance of the air on its anterior part, acting at a point, termed by General Maievsky its "centre of resistance," will not be opposite to its centre of gravity, and hence a couple tending to deflect the rocket will be established.

On page 256, the case of a rotating elongated projectile proceeding in a direction not coincident with that of its axis is discussed. The case of the rocket somewhat resembles it, the tendency of the rotation to resist the deflecting couple, being answered by the mechanical action of the stick (described page 225); the velocity of rotation and the length of the stick being the relative "functions" of the steadying force in the two cases.

Now the stick of the life-saving rocket is not only placed on one side, but is also a little curtailed in its length; it may therefore be readily seen that this rocket is constructed on the supposition of its carrying a line, when the pull of the line from the starting point will act to draw the stick and rocket into the production of the line of flight it has taken up to the moment considered; this steadying power (in spite of the wind carrying the middle of the line in a bend to one side) becomes very great indeed after the rocket has proceeded any considerable distance.

From this may be deduced two facts, which it may be vitally important to consider in firing the rocket:—

1st. That the wind will carry the rocket and line with it, because it will not have the power to deflect its axis so as to point the rocket up the wind.

2nd. It is very desirable to start the rocket at a momentary lull. For if the first action of the wind carries the rocket to one side it will exert its force afterwards in prolongation of this incorrect direction.

If the rocket machine be brought into action on uneven ground, causing the foot on one side to be lower than that on the other, or if one foot sink deeper than the other, as might occur in yielding sand, the effect will be to cause the rocket to carry towards the lower side.

*Issue.*

Six rockets in a packing case.

*Issue.*

## EXPERIENCE AS TO RANGE AND ACCURACY.\*

In 1868,—52 rockets fired in succession, in course of proof at 35° elevation, gave an average range of 378 yards, which may be considered

---

over the land, the sudden paying out of its line would cause it to drop on the shore. Capt. Robertson, R.N., informed me that a man has been known to swim from a ship with a line, assisting himself by a kite; it is here obvious that the kite might have carried a light line by which might have been passed stronger ones till a hawser was at last carried across.

\* The following are answers which were kindly furnished by Mr. J. F. Spence, Honorary Secretary to the Tynemouth Life Brigade, to some of my questions. I think most readers would prefer having such answers "verbatim" to any summary, which would destroy their character and the spirit which runs through them. It would be difficult to quote a better authority than Mr. Spence in these matters.

The quickest successful performance of work you remember?

"This was with the schooner 'Light of the Harem,' wrecked behind Tynemouth North Pier, on the 8th February last (1870). The rocket was fired at 30 minutes past  
*cont.]*



a low one it certainly includes one or two exceptionally short ranges). The minimum one being 286 yards, the maximum 450 yards. The

---

4 p.m., and the first man was landed in 14 minutes, the last man (there were five of them) in 24 minutes from firing the rocket. That was nearly 5 minutes a man; this would have been much more quickly done, but the men on board the schooner did not understand how to use the apparatus, and so delayed many minutes; you will notice the four last men were landed in 10 minutes; the first man occupied 14 minutes; but as I said this arose in a measure from their ignorance of how to act."

As to kinking of manilla lines, &c.

"The rocket lines are now made of hemp (at least so we suppose), and are much more softly laid than they used to be. The result is, they rarely kink, we still have the old trouble with the lines fouling as they are drawn off; that is when the whip line is on board and made fast; you then attach the hawser, leaving about two or three fathoms free, in order that the wrecked people may more easily fix it to the mast. This free end is very liable to take turns round the whip in hauling off, and the result is, and often has been, that the breeches buoy cannot be hauled off to the ship. In daylight if this happens any sailor sees it at once, and can put it right, but in a dark stormy night, this is much more difficult to do, and when they think they are taking the turns out, they may be making more. It also necessitates slacking off the hawser, so that the people on board ship may loose it to get the turns out."

'The greatest range you have reached:—

"I presume you will mean when firing at a ship in distress. On the 8th February 1870, at 3.30 p.m., a large barque was stranded on the 'Spar Hawk,' a spit of sand about half a mile east of the 'Black Midden Rocks,' at the mouth of the Tyne; she would be about 350 or 360 yards, at least 350 yards by *measurement* from the nearest point of the rocks on which we could stand to use the apparatus. The first shot fell far short of her, we suppose, because it had not sufficient elevation, and the line was wet. The second rocket was laid with a few degrees more elevation, with a new rocket line quite dry and fresh, and flew right between her masts. The line is 250 fathoms in length. I think there might be 10 or 12 fathoms of the line left in hand. The wind was S.E. by S., force 10, blowing almost athwart the line. This was a grand shot; I never saw a better. No one thought the vessel could be reached."

Whether you generally lose one or more rockets before you establish a communication?

"The force of wind, and position in which the ship lies, with respect to the direction of the wind, and situation of those on shore who are endeavouring to establish a communication, greatly affects this question; for instance, there may be a sudden lull in the violence of the wind, and you think to take advantage of it, lay your rocket accordingly, and fire; just as you pull the trigger line, the squall returns with renewed force, and the consequence is, your rocket is carried far away from the object aimed at. In most instances, however, we have succeeded in throwing the line over wrecked ships the first shot; I think we only missed once,—in the case I have detailed to you.—Then comes another difficulty; take an instance, on the 8th February this year at 4 o'clock a.m., the 'Susannah,' a schooner, was wrecked on the Black Midden Rocks, wind S.E., force 10. It was about 500 yards from the station to the point of rocks, the nearest we could reach to her. In 22 minutes we fired the first rocket, which went right over her, but there was no attempt to pull the line on board, we went on firing rockets till five in all were expended. The lines all fell over the vessel, but it turned out that the rigging was in such a wrecked state that the men could not disentangle one of them from it, till the last one was fired, which went clear. In 10 minutes from this time, we had the first man ashore, and in 12 minutes more, the other three, but they were very much exhausted, as it was nearly 7 o'clock a.m. when we got them. For two hours and a half they had been exposed to the full fury of the storm, every wave rolling over them; one man was lost,—washed overboard with one of the masts."

Do you find the system of work so far understood generally, as to enable the crew to conform to your operations?

"In many cases I say they do not; this is one of the difficulties we have to contend with on a dark night; and with a ship at such a distance from the shore that we cannot make the crew hear. I have urged strongly on the Board of Trade to have a clause in the new Merchant Shipping Bill, making it compulsory on all owners of seagoing vessels of all descriptions to have their simple directions as to know how to use the apparatus painted on a piece of tin, and nailed to the mast, or in some con-

cont.]

average deviation from the line on which the rocket was laid was 42 yards.

In 1870,—131 rockets fired successively at proof, gave an average range of 373 yards, the maximum range being 470, and the minimum 330, the mean deviation being about 35 yards.

In calculating for the effects in cases of storm, rather a low range

spicuous part of the vessel, so that the sailors cannot help learning what they have to do when wrecked, and a rocket or shot is fired over them. I never knew a crew to establish communication with a kite, but have heard of its being tried. I fear in case of shipwreck it would be difficult to set a kite up."

The following accounts, taken from the annual reports of the Volunteer Life Brigade of the borough of Tynemouth, will enable any officer to realize the kind of difficulties likely to occur in the actual course of work :—

"As was noticed in last annual report, but few south-east gales of any length of continuance or severity have occurred since the year 1864, when the S.S. Stanley was wrecked; but, as might be expected on the occurrence of severe gales from that quarter, during the past winter, several wrecks took place at the north side of the mouth of the Tyne, and it was during one of these gales that the Brigade had the great satisfaction and privilege of landing the crews of two vessels, with the exception of one man who was washed overboard with one of the masts which was carried away by the force of the waves. In the case of the 'Susannah,' which was stranded about four o'clock on the morning of the 8th February 1870, it seemed at times as though there was little hope of saving the crew. She was so much disabled in her masts and rigging before drifting ashore, and had so much wreckage hanging about her, that rocket after rocket was fired (five in all) before any practical communication could be effected with the ship, all the rocket lines becoming so entangled in the rigging that the men on board could not clear them. Finally however, after two and a half hours working and waiting, the persistent efforts of the Coast Guard and the Brigade were crowned with success. It was during the continuance of this storm, about 3.30 in the afternoon of the same day, that the barque 'Helena' of Scarborough, with a crew of 17 hands and the pilot, came ashore in a violent snow squall on the edge of the Spar Hawk; she was at a considerable distance from the nearest point where the apparatus could be set up, and there seemed some doubt about reaching her with a rocket. The first shot fell far short, but the second rocket went right between her masts, and was secured by one of the men; the life boat, however, coming alongside soon after, the crew very wisely took to her rather than run the risk of being dragged through the surf and over the rocks amidst the raging sea, which must of necessity have been a very hazardous operation. Whilst this was on the way, the cry was raised that another vessel was going behind the North Pier, a most dangerous position; the chief officer of Coast Guard, Mr. Quick, immediately told off some of the volunteers, with one or two of the Coast Guard to go to her assistance. In a short space of time they had the satisfaction of landing the whole of the crew, though not a moment too soon, as about eight minutes after they were ashore, the schooner was broken up by the fury of the storm, not a piece of her being left on which they could have saved themselves. She proved to be the schooner 'Light of the Harem,' of Lowestoft.

"In the case of the 'Burton,' of Wivenhoe, wrecked on the 19th March 1865, a rocket line was thrown over her in two minutes from the time she touched the rubble of the North Pier, but in seven minutes she went entirely to pieces, the poor fellow who climbed the rigging to lay hold of the rocket line not having time even to reach it, only one man was saved out of the crew of five; he was picked up by the life boat.

"Again on the evening of the 11th October 1865, about 7 p.m., the schooner 'Ringwood,' of Yarmouth, with a crew of five hands, when endeavouring to enter the harbour in a stiff south-east gale, came ashore on the Black Middens. The rocket line was speedily over her and the whip attached, but was not hauled aboard. It was soon found that the men, who were used to the Yarmouth beach, had left the vessel in their boat, which unfortunately capsized, and two of them were drowned; had they remained on board and used the apparatus, there is little doubt they would all have been saved. On the third occasion, the 29th December 1865, three vessels came ashore under the battery; rockets were fired over two of them, but the men did not seem to understand the use of the apparatus, and instead of hauling the line aboard, fastened a warp to it, and commenced paying out towards the shore. In the meantime the life boat came alongside and saved the whole of the crews."

must commonly be expected, the wind generally blowing more or less against the direction which the rocket has to take.

The following is a return of the number of rockets fired at each drill of the Borough of Tynemouth Life Brigade, from 1st July 1866, together with the range in yards as near as could be ascertained; the deviation right or left of the rocket of the object aimed at; the time in minutes and seconds between firing the first rocket and landing the first man, and the number of men present on each occasion. Compiled for the Board of Trade returns by John F. Spence, Honorary Secretary. Previous to 1866 no record of these particulars was kept:—

Date of Drill.	Number present.	Rockets fired.	Range in Yards.	Deviation, Right or Left, in Yards.	Time from firing to landing of first Man, in Minutes and Seconds.	Remarks.	
1866.							
July 28	58	1	Always fired from the same position and varied from 240 to 300 yards.	7 to left.	Varied from 9½ to 15 minutes. The object aimed at varied from 180 to 240 yards distance.	¹ Nowhere. Rocket frame upset and rocket flew off.	
Aug. 25	47	1		2 to right.			
Sept. 22	47	2		1 nowhere.¹			
Oct. 26	39	1		4 to left.			
Nov. 29	42	1		Hit.			
Dec. 23	44	1	2 to left.				
1867.							
Jan. 19	46	1		1 to left.		End of official year.	
Feb. 16	53	1		Hit.			
March 13	59	1		Hit.			
April 12	35	1		4 to right.			
May 11	29	1		2 to right.			
June 14	39	1		Hit.			
July 12	46	1	About 230	Hit.	14 0		
Aug. 9	41	1	" 290	Hit.	8 30		
Sept. 6	44	2	" 340	Hit.²	15 45		
Oct. 4	75	1	" 290	Hit.	7 40		
Nov. 2	60	1	" 280	4 to right.	8 45		
Nov. 30	51	1	" 285	10 to left.	²⁰ 0		
Dec. 23	38	1	" 250	Hit.	15 0		
1868.							
Jan. 25	72	3	" 200	{ 30 to leeward. 10 do. }	11 0	⁴ Rocket stand fell twice into the sea.	
Feb. 22	67	1	" 210	5 to left.	12 0		
March 21	50	1	" 260	Hit.	15 30		
April 18	41	1	" 280	2 to right.	12 15		
May 15	42	1	" 270	Hit.	10 30		
May 29	64	1	" 280	4 to left.	9 40		
June 26	44	1	" 265	Hit.	7 30		
July 24	45	1	" 280	Hit.	12 30		
Aug. 21	55	2	" 270	3 to left.	14 0		
Sept. 19	46	1	" 260	4 to right.	16 0		
Oct. 17	30	1	" 320	3 to right.	15 0		
Nov. 14	38	1	" 330	10 to left.	11 0		
Dec. 12	51	1	" 280	Hit.	12 0		
1869.							
Jan. 9	49	2	" 260³	4 to right.	10 30	⁵ Trials of new iron triangle double and single apparatus.	
Jan. 29	60	1	" 250	Hit.	17 0		
Feb. 10	36	1	" 320	Doubtful.	19 0		
Feb. 11	36	1	No account kept, as there was no opportunity of doing so				
March 6	33	1	About 330	Hit.	17 0	No time kept, as the drill was constantly stopped to make explanations to the American Ambassador.	
March 31	34	1	" 300	Hit.	American Ambassador Hodgson's storm escape.		
April 30	58	1	" 280	3 to left.	12 0		
May 28	52	1	" 320	Hit.	6 0		
June 25	37	1	" 250	1 to left.	20 0		
Aug. 6	40	1	" 280	2 to left.	13 30		
Sept. 3	50	1	" 340	Hit.	11 0		
Oct. 2	34	1	" 190	12 to left.	12 0		
Oct. 30	48	1	" 300	10 to right.	19 0		
Nov. 27	42	2	" 340	Miss, 10 to left.	18 30		
Dec. 23	37	1	" 320	Hit.			
1870.							
Jan. 22	43	1	" 310	Hit.	12 0	⁶ One fired to sea without a line.	
March 19	06	1	" 290	Hit.	17 0		
April 14	48	1	" 300	12 to left.	19 0		
April 23	79	1	" 220	4 to left.	12 30		
May 20	45	2⁴	" 290	3 to left.	12 0		
June 24	35	1	" 300	Hit.	14 0		

WRECKS which have occurred at Tynemouth since the Year 1865.

No.	Date of Wreck.	Place of Wreck.	Hour of Wreck, and whether a.m. or p.m.	Name of Ship.	No. of Hands on Board.	No. of Volunteers present.		No. of Rockets fired.	Time in Minutes and Seconds between first Rocket and landing first Man.	No. of Lives saved.
						Offic-ers.	Men.			
1	1865, Mar. 19	Rubble of North Pier	4 p.m.	Burton	5	About 60		1	Landed by life boat	1
2	" Oct. 11	Black Middens	7 p.m.	Ringwood	5	About 65		1	Endeavoured to land in their own boat.	2
3	" Dec. 29	Under Spanish Battery	4 p.m.	Union	10	About 30		2	Did not know how to use apparatus, saved by life-boat.	10
4	" " 29	Ditto	"	Leves	10	"		—		10
5	" " 29	Ditto	"	Windyard	10	"		None	Saved by life-boat	10
6	1869, Dec. 26	Battery Rocks	9.56 p.m.	Viscount McDuff	6	5	48	1	Ditto	4 <sup>1</sup>
7	1870, Feb. 8	Black Midden Rocks	4.8 a.m.	Susannah	5	6	63	5	2 hours 8 minutes	4
8	" " 8	Spar Hawk Sand	3.34 p.m.	Helena	14	6	51	2	Saved by life-boat	14
9	" " 8	Behind North Pier	4.20 p.m.	Light of the Harem	5	6	82	1	14 minutes	5

<sup>1</sup> Two washed overboard on the Bar.

1. Rocket line over the Burton in two minutes from the time she struck, but she broke up immediately, and in 5 minutes more was all in pieces.  
2. Crew of the Ringwood, used to the Yarmonth beach, as soon as she struck took to their boat and tried to land, she was swamped and three of crew drowned, the other two washed ashore. All might have been saved if they had waited to use apparatus.

3, 4, 5. Men did not know how to use the apparatus. Instead of hauling rocket line aboard, they tied a warp to it and commenced paying it out to the shore.  
6. Came up close to the life-boat house, and were landed by the boat.

7. Mast of the Susannah carried away by the waves, one man washed overboard with it.

8. The life-boat came alongside, and the men preferred taking to her rather than being dragged over 300 yards through the waves.

9. Ship broke entirely up 10 minutes after the last man was saved.

During the winter of 1870-71 several wrecks occurred off Tynemouth harbour, providentially in such situations that the crews were rescued by the brigade. This will greatly increase the number of lives saved in any future table.

NUMBER of LIVES saved from Shipwreck on the Coasts of the United Kingdom during the Years 1856 to 1868, distinguishing the means by which they were saved.

By what Means saved.	Total.												
	1856.	1857.	1858.	1859.	1860.	1861.	1862.	1863.	1864.	1865.	1866.	1867.	1868.
By life-boats - -	362	398	206	291	326	743	327	505	306	396	353	453	418
By rocket and mortar apparatus, and assistance with ropes, &c. from shore.	262	243	210	260	408	447	310	357	196	409	516	474	241 <sup>1</sup>
By luggers, Coast Guard boats, and small craft.	1,184	512	719	1,009	635	298	407	576	263	323	439	478	768
By ships and steam boats.	407	507	394	766	769	971	1,082	1,500	1,289	914	973	1,109	861
By ships' own boats -	—	—	—	—	1545 <sup>2</sup>	1,560	1,488	1,454	1,379	1,768	2,275	2,544	1,887
By individual exertion	28	8	26	6	14	28	13	13	18	6	5	13	6
By other means -	—	—	—	—	—	577	412	691	163	346	375	774	659
Total - -	2,243	1,668	1,555	2,332	3,697	4,624	4,039	5,093	3,619	4,182	4,936	5,845	4,771

<sup>1</sup> In all 4,333.

<sup>2</sup> No records kept for former years.

### WHALING EQUIPMENT.

A tube somewhat resembling the signal rocket gun, and a harpoon rocket fired by means of a detonating tube, very similar to that used for the life-saving apparatus have been supplied in the equipments of arctic expeditions, but no sealed patterns exist, and if an order came to manufacture stores of this nature, it is questionable whether they would exactly resemble those previously made and issued.

## APPENDIX.

---

### NOTES ON THE FLIGHT AND PENETRATION OF PROJECTILES.

Lieut. Sladen, R.A., Royal Laboratory, writes with reference to the Lt. Sladen. resistance of the air during flight—

“From recent experiments carried on at Shoeburyness with Professor Bashforth’s Chronograph, some important results have been obtained with regard to the resistance of the air to variously shaped projectiles.

The point, I purpose to bring to your notice in this letter, is the experimental proof that the *total* resistance to a projectile moving with a given velocity in the air, is made up of (1) the resistance to the head, (2) and the resistance or “*minus pressure*” on the base.

Now it has been found that the total pressure on a 9-inch spherical shot, moving with a velocity of 1,130 feet seconds, is about 555 lbs. (A N B M representing the spherical 9-inch shot), and the total pressure on a hemispherical headed elongated shot of the same diameter (represented by A C D B M), and moving with the same velocity, is 487 lbs., thus showing a difference of 68 lbs. in total pressure.

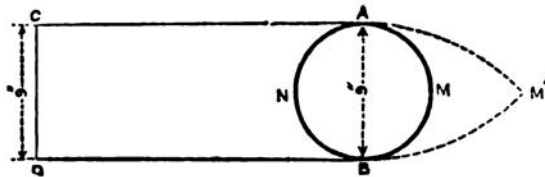

Now supposing the elongated shot to move steadily point first, the pressure on the respective heads A M B must be the same, therefore the difference of total pressure, viz., 68 lbs., must be due to the difference of minus pressure on the bases A N B, A C D B respectively, thus showing conclusively that the form of base of a shot materially influences the total pressure which it meets with when moving through the air at a high velocity.

The total pressure on a service ogival headed shot of 9 inches in diameter (represented by A C D B M') is only 389 lbs., thus showing the great difference of pressure (viz., 166 lbs.) on an elongated ogival headed shot and a spherical shot of the same diameter when moving at the same velocity through the air. Another advantage which the elongated shot possesses over the spherical is that for the same calibre the momentum of the former is much greater, varying of course in proportion to their respective weights, which would be nearly three to one, depending on the length of the elongated projectile.



These two principles taken together constitute the great superiority which elongated rifled projectiles possess over spherical projectiles.

These considerations would indicate the superiority in every respect of rifled over smooth bore mortars, as owing to the longer time of flight these principles have a longer time to act, and therefore would produce more marked results than in the case of horizontal firing."

**Gen. Maievsky.** The investigations of General Maievsky, as to the forces acting on projectiles in flight and penetration, are such that they form a study of great magnitude, involving peculiar applications of the highest mathematics. It would be idle to attempt to take up the pursuit of this subject without making it a regular course of study. A few of Maievsky's results quoted by Mr. Mallet in his papers in the "Engineer,"\* as well as notes on the subject of penetration, as discussed by Mr. Mallet, may be found valuable although briefly given in general terms.

1st. As to the irregular spiral path described by rifled projectiles in flight :—

General Maievsky supposes the projectile to be proceeding on a path not absolutely coincident with its axis, and shows that the point where

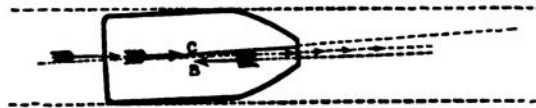

the resultant of the resistance on the anterior part of the projectile intersects its axis (which he terms the "centre of resistance"), not being exactly opposite to the centre of gravity, the force of projection and that of resistance act so as to form a couple BC which tends to deflect the head of the shot, this being opposed by the centrifugal force due to rotation and the effect varying continually, the axis of the projectile constantly describes in space a form approaching a cone, the path of its centre of gravity being a helix or spiral.

General Maievsky arrives at the conclusion that the helix becomes wider and wider,† as the projectile proceeds further and further on its path.

When the centre of resistance coincides with the centre of gravity then there is no deflecting couple and no tendency to alter the direction of the axis of the projectile which is merely lifted or pressed downwards, the range being increased or decreased by the action of the resisting force, which acts in the plane in which the trajectory and the axis of the projectile are situated.

\* Also partly taken from "Revue de Technologie Militaire," Vol. V., p. 101.

† Facts seem to contradict this, and though General Maievsky gives reasons in support of his conclusions, it seems likely that the conditions of the question are affected by the velocity of translation (and hence the disturbing cause, viz., the resistance of the air) decreasing much more rapidly than the velocity of rotation.

The small diminution of the velocity of rotation, as compared with that of translation, is a fact that has been frequently overlooked, and the strong reasons there are for believing that the flight of the projectile increases in steadiness suggest the doubt whether General Maievsky has sufficiently considered these disproportionate rates of decrease in his investigations.

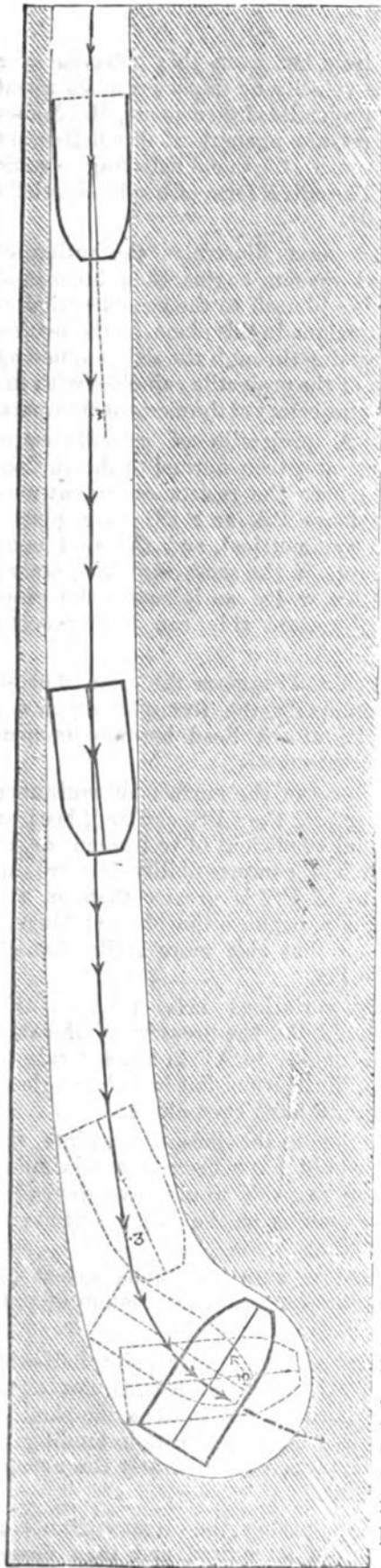

With regard to penetration the writer assumes that friction causes the rotation very shortly to cease, and gravity may be neglected in the investigation of this subject.

Hence if the projectile entered truly at a normal to the surface of the resisting medium, and its axis was also coincident with the same, the path through the medium penetrated would continue in the same straight line, practically this cannot occur, so that the path of the projectile into the medium may be said to lie in the plane passing through two lines:—

1st. The direction in which the centre of gravity of the projectile is moving at the moment of impact, and,

2nd. The axis of the figure which may be assumed to be at a small angle  $S$  with the first.

If the direction of motion is at right angles or at a normal to the surface of the body it penetrates, the resistance of the same tends to increase the angle  $S$  made by the axis of the projectile with the path described by its centre of gravity, while it also deflects the path itself towards the same direction; finally the projectile comes to rest with the angle  $S$  sometimes as high as  $80^\circ$ , while the deflection of the path itself may be such that the point of the projectile is towards the rear, that is, pointing towards the surface where it entered, as in fig.

The above result has actually occurred in firing projectiles into earth, and the projectiles when dug out have been found with their points towards the side at which they entered.

These effects cannot be fully developed in penetrating such material as armour plates, and Mr. Mallet in his paper next discusses the actual effects which are produced by various forms of projectiles in piercing armour, on the supposition that it is "a homogeneous plate of parallel thickness of a malleable material," which is not completely penetrated by a rigid projectile.

The greatest resistance is made by

R

tough and moderately soft wrought iron, but even this behaves as a more or less brittle body whenever the velocity of impact reaches about 560 feet per second. The entrance of projectiles into armour, Mr. Mallet considers then as accompanied by a certain amount of direct fracture and a certain amount of lateral displacement, the metal behaving to some extent as a plastic and flexible body. The ogival form of head is specially adapted to perform this work effectually.

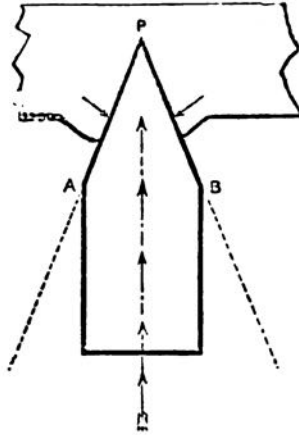

Mr. Mallet next illustrates the action of penetration at various angles in a horizontal plane, confining himself to the consideration of effects of distortions in this plane, on the lamina of the shot passing through the axis, supposing that the axis of the projectile coincides with the tangent to the trajectory at the moment of impact.

1st case.—A projectile of cylindro-conic form entering at a true normal to the surface of the plate; here the resistances act at normals to the faces PA and PB; the plastic distortion is symmetrical, and the shot continues its course in the same direction, acting like an isosceles wedge as it enters the plate (as has been noticed this can hardly occur actually).

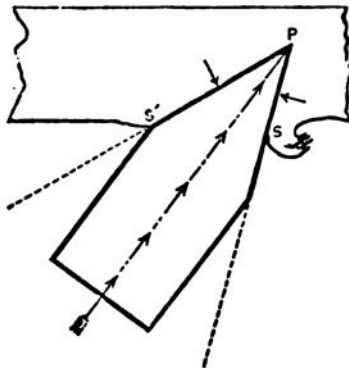

2nd case.—Suppose the same shot to enter obliquely, the forces acting on the two sides of the head become unequal for two reasons:—

1st, because the surface of resistance PS' is greater than PS, and 2nd, because the actual coefficient of resistance (*i.e.* of friction and compressibility jointly) on the side of PS' is greater than on the side of PS, because the plate yields and bulges on that side more easily than on the side PS.

Many variations arise even in this simple case; in the angle given by Mr. Mallet the pressure of the shot at a normal to its head, *i.e.* at right angles to AP in fig. 4, tends to force the plate up in the burr of the illustration, but had the angle of incidence been less oblique the case would have been altered.

Had the line SP been at right angles to the face of the plate, the *coefficient of resistance* on that side would have been at a maximum, and the preponderance of resistance on one side would have depended on the relation of the smaller coefficient acting on the larger surface, to the larger coefficient on the smaller surface.

In this particular case the coefficient is at a maximum, but at all angles of incidence between that and the normal this question of preponderance remains the same.

Taking the resultant of these resistances to act at a point half-way along the faces PS' and PS, which, as Mr. Mallet notices, is not absolutely true, even considering only the horizontal lamina of the shot in question, it may be seen that there arises a dynamic couple tending to deflect the shot and cause its path to approach more nearly the normal to the plate (*i.e.* cause the shot to turn in).

Mr. Mallet next considers the forces opposing the direct entrance of a flat-headed cylindrical projectile and of an ogival, and then passes

to the important question of their respective powers of penetration at various angles.

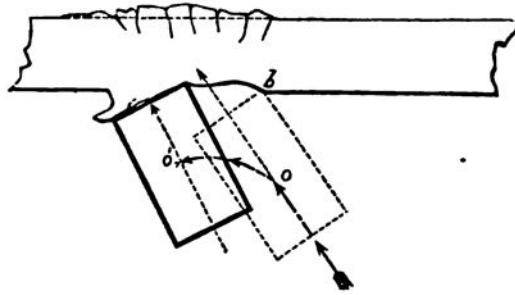

The flat bolt striking at an angle shown in fig. 5 has a tendency at first to rotate on  $b$  (turning in).

But Mr. Mallet considers that as it proceeds further, on principles which apply to the circumstances which he discussed in the case shown in fig. 4, its centre of gravity  $o$  advances and slides towards  $o'$ ,\* in a direction making a variable angle, greater or less, towards the interior of the plate, the plastic face of which is cut out in a sort of curved form shown in fig. 5, and the material excavated is pushed before the face of the shot, adding to the thickness of the plate to be removed before penetration is effected. Hence Mr. Mallet considers that a flat-headed shot can only penetrate under these circumstances at the expense of great waste of work, and under ordinary circumstances glances off the plate, base first, before it is able to "*immerse itself deep enough to become encastré in its substance.*"

As it glances off it probably continues to whirl rapidly end for end, on a transverse axis.

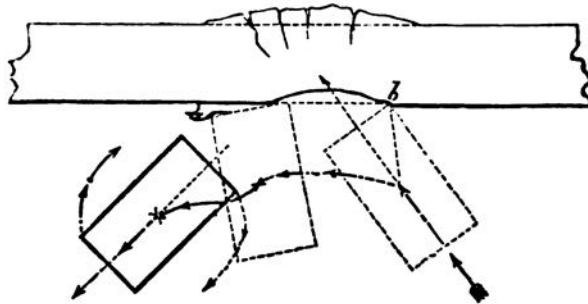

The cylindro-ogival shot, if the angle of incidence be greater than that made with the axis of the shot by a tangent to the curve of the head at the point, digs its point in at once and "the centre of gravity" of the shot at the same time goes forward, turns round more readily "at first than the flat-ended shot upon an equatorial axis, and slides" in the direction of a line making an angle, more or less, towards the

\* With regard to the flat-headed shot there is a tendency to slide from the component of the velocity resolved in a direction parallel to the plate and a tendency to turn in from the resistance acting as a normal to the flat head at and near the edge  $b$ ; hence it both slides and turns in rapidly, though it is difficult to say how nearly in the relative proportions shown by Mr. Mallet.

Probably the direct punching of the flat-headed shot compares better with the wedging open of the ogival head if the plates are *very hard*.

“ internal side of the face struck. The forward part of the shot thus  
 “ cuts out and partly pushes before it, normally to the face towards  
 “ which it slides, the plastically distorted part of the iron, and bulges  
 “ or not the opposite face in an *umbo*, whose conditions are such as  
 “ referred to in fig. below.”

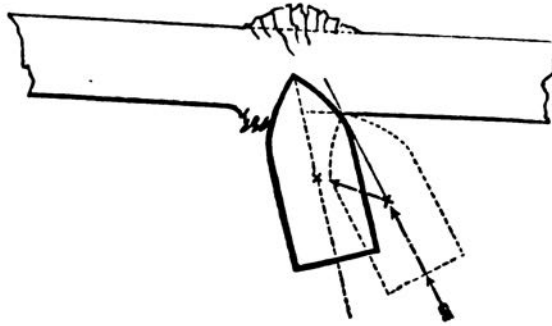

Mr. Mallet, however, considers that the shot of this form soon becomes encastré at its point as regards rotation in the plane of the figure, so that further rotation is prevented by the support at the left side of the head, and also near the point on the right side, the shot finally assuming the position shown in fig. following.

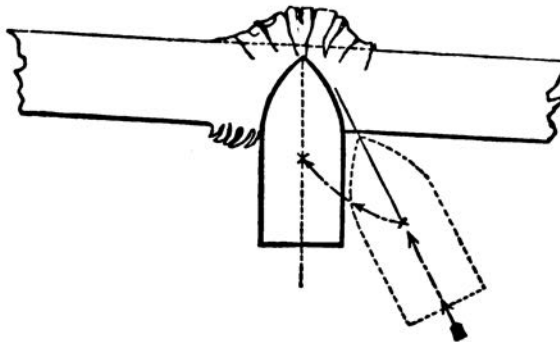

Mr. Mallet further considers that friction may even cause a shot of ogival form to turn, catch its point and penetrate when impinging on a target at an angle of incidence slightly less than that of a tangent to the ogival curve at the axis.

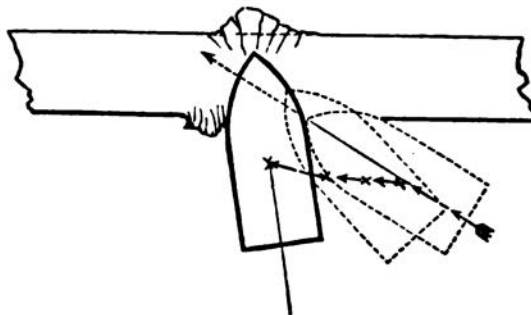

Passing on to the question of still more oblique impact as against convex plates, Mr. Mallet shows that the ogival-pointed shot may

glance off *point first*, when there is not enough plastic distortion to hold the point,

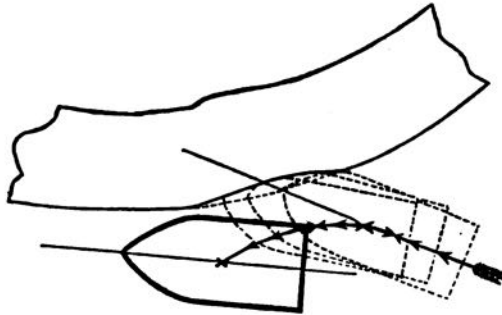

and *base first* when the point is caught but not held.

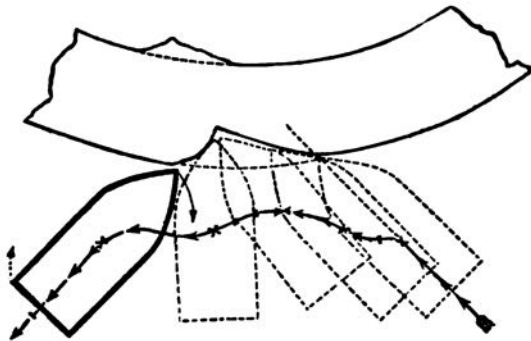

The question of impact against a concave surface is referred to (*vide* fig. below) to illustrate the small power of deflection and the great improbability of a shot glancing off when so fired, and—

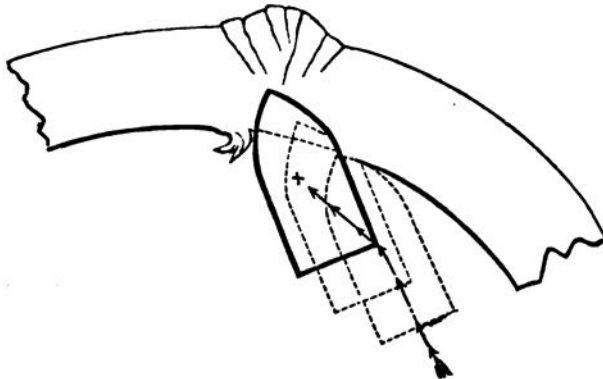

Lastly, Mr. Mallet notices the conditions which cause a shot to ricochet on water, in spite of the slight tendency there is to turn downwards before the head becomes immersed, owing to the inequality of



the resistances on the front of it, the coefficient of resistance being much less on the upper side.

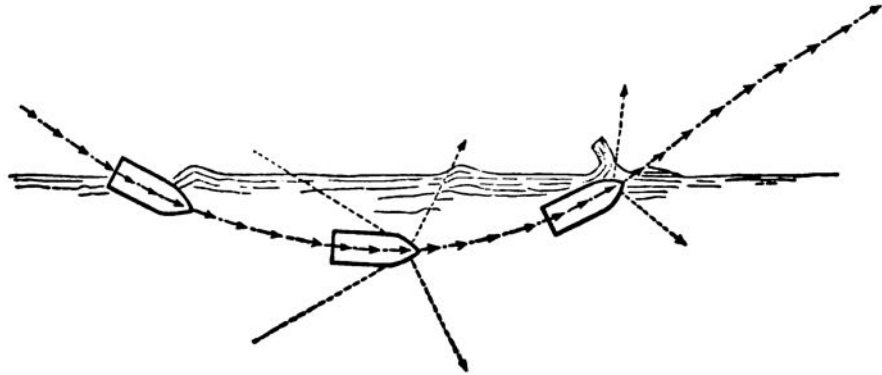

Comparing the wave to that caused by an earthquake (*vide the Engineer*, 1867, January 4th, 11th, 18th, and 25th).\*

N.B.—It may be observed that the power of turning in instead of glancing off *point first* when striking on armour at an oblique angle increases with the radius of the circle with which the ogival head is described, inasmuch as the limiting angle of penetration is approximate to that made by the tangent to the ogival curve at the apex with the axis of the projectile, *i.e.*, the limiting angle of penetration with ogivals of various radii may be said to be approximately as follows:—

For 1 diameter -	-	-	-	60°
” 1¼ ”	-	-	-	53° 8’
” 1½ ”	-	-	-	48° 12’

#### *Complete Penetration of Armour Plates.*

Capt. W. H. Noble on complete penetration.

In a report on the experiments relative to the penetration of armour plates by steel shot, printed in 1866, Captain W. H. Noble, R.A., discusses the means that exist of comparing the thickness of armour up to 4½ inches of plate, pierced by various projectiles, and also of calculating the probable effect that may be expected from any projectile.

He shows that the formula  $\frac{WV^2}{2g}$  which he expresses in “foot tons,” gives the “work” done by the shot on striking very correctly, whether of a light projectile with a high velocity, or a heavy one with a low velocity; further, he considers that penetration is in inverse proportion to the circumference of the shot.†

\* Observe the beauty of the effect of the *inelastic* medium water on the lower side pressing against the bottom and superincumbent mass, and on the upper side lifted in a wave, as shown in fig.

I conclude the ricochet will be repeated until the *difference* of the pressures caused by the resistance of the water against the lower half and upper half of the anterior surface of the projectile, which is a function of its velocity, becomes less than the vertical downward component of the shot.

† It must be observed that the calculation only applies to the question of complete perforation, when the plate may be supposed to be sheared along the line corresponding to the circumference of the projectile. This would be most nearly correct in the case of flat-headed shot.

Captain Noble gives the equation :—

$$\frac{WV^2}{2g} = 2 \pi RK b^2.$$

Where W = weight of shot in lbs.

V = velocity on impact.

g = force of gravity.

2R = diameter of the shot in feet.

b = thickness of unbacked plate in feet.

K = a coefficient depending on the nature of the wrought iron in the plate, and on the nature and form of head of the projectile.

This equation may be solved according to the problem required, when it is obvious if the other conditions are given any of the following may be obtained :—

The thickness of plate pierced by a given shot with a given velocity.

The velocity required to cause a given shot to pierce a given plate.

The weight of shot of a given diameter and velocity required to pierce a given plate.

For practical purposes the following facts have been furnished by Capt. Noble to enable officers to form a general idea as to the probable power of their fire :—

Calibre.	Striking Velocity.	"Work."	"Work" per inch circumference.	Charge in lbs.	Target.	Result.	Remarks.
7	1210	1170	54	13	Warrior*	Through - -	Fired direct.
7	1420	1590	73	22	Warrior*	Through - -	At an angle of incidence of 60°.
7	945	718	33	9	Solid iron	6" penetration.	
7	1430	1630	75	22	10" plate	8½" penetration.	
9	810	1140	41	14	8" plate	5" penetration.	
9	850	1250	44·7	15	8" plate	5·3" penetration.	
9	1300	2930	105	43	8" plate	Through - -	Also through backing of 18" teak and ¼" skin.
9	1230	2830	101	37	Gibraltar†	10½" penetration.	
10	1257	4393	141	60	15" plate	10" penetration.	
10	1259	4392	141	60	15" plate	12·2" penetration.	
12	1165	5685	152	76	15" plate	10·7" penetration.	
12	1173	5763	154	76	15" plate	12·2" penetration.	

\* i.e., 4½" plate, 18" wood back, ¼" skin.

† 12" of compound plates.

For penetration of Palliser projectiles, see p. 164.

**SALUTING AND EXERCISING CARTRIDGES OF SILK CLOTH, FOR MUZZLE-LOADING IRON GUNS, LAND SERVICE.**

1. Adverting to § 1780 in List of Changes, June 1869, it must be fully understood that the object of the introduction of silk cloth cartridges is to lessen the risk of accident consequent on rapid firing from the same gun or guns.

2. The use of these cartridges will therefore be restricted, *first* to the firing of salutes at such stations as are named in the Queen's Regulations, provided the number of guns available for firing salutes is less than the number of rounds to be fired; *secondly* to garrison guns fired at reviews (such as are specially allowed to be held at Dover and Portsmouth), when authorised by the Secretary of State for War; and *lastly* to the guns used in the "dismissal" of recruits of Garrison Brigades.

3. On receipt of this order, the nature of the guns to be used, in future, for salutes (at those stations where salutes are authorised to be fired), and for the dismissal of recruits, will be decided upon by the general or other officer commanding the troops at the station, and notified in General Orders, and a copy of the order transmitted for the confirmation of the Secretary of State.

4. In the event of the gun or guns selected not being of the smallest available calibre, the reasons for the selection made will be given.

5. At those stations, where morning, noon, evening, and signal guns are authorised by the Secretary of State to be fired, cartridges of the present pattern and charge will be made use of, and also for all other purposes not involving risk from rapid firing.

6. Estimates of the quantities of silk cloth cartridges required for the different calibres for two years' future expenditure will be prepared in accordance with the foregoing conditions, by the officer commanding the Royal Artillery at each station, and will be based on the actual expenditure of the last two years, with such modifications as may be probable in the ensuing year.

7. The estimated quantities required for salutes, for reviews, and for the dismissal of recruits, will be shown separately; the estimate will be submitted for the approval of the general officer commanding, and be forwarded to the district controller.

8. On receipt of these estimates the district controller or commissary in charge, after carefully checking the same, will consolidate the whole into one demand, which will be forwarded to the Controller, Royal Arsenal, Woolwich, for supply, on the approval of the Controller-in-Chief being obtained.

9. On receipt of the cartridges by the store officer of the station, they will be held in charge until required by the Officer commanding the Royal Artillery, who will from time to time make such demand as the expenditure renders necessary.

10. The cartridges required for the usual salutes will be supplied with the sanction of the general or other officer commanding on authority conveyed by the district controller.

11. The cartridges for reviews will be issued on the authority of the order of the Secretary of State for War for the holding of the review, and for the guns to be used, being given.

12. The cartridges for the dismissal of recruits, namely, six rounds will be issued on the authority of the Regulations for the Supply of Ammunition, dated February 1869, page 5, section 4.

13. Before supplies are made, on the authority of the foregoing three paragraphs, the controller will be responsible that the conditions of the supply, as well as the quantities, are correctly stated.

14. Clauses 2, 6, and 7 of § 1780 of List of Changes, June 1869, will stand; the remaining clauses are hereby cancelled.

*Army Circular, 1st July 1870.***PAPER CYLINDERS AND SOCKETS OF AMMUNITION FOR BREECH-LOADING ARMSTRONG GUNS.**

1. Commanding officers of the Royal Artillery and control officers at home and abroad who have in charge any made-up gun ammunition of more than 12 months date of the following varieties,—

$$\text{Armstrong B.L.} * \begin{cases} 20\text{-pr. } 2\frac{1}{2} \text{ lbs.} \\ 40 \text{ ,, } 5 \text{ ,,} \\ 7\text{-inch } 10 \text{ lbs., } \dagger 11 \text{ lbs.} \dagger \end{cases}$$

will take immediate steps to ascertain whether the paper cylinders and sockets are in a sound and serviceable condition.

2. For this purpose they will open all the cartridges in one case or barrel for every ten on charge, and one cartridge in each of the remaining nine cases, also a corresponding proportion of cartridges in the limbers of the batteries of position, and carefully observe and record the state in which they find the cylinders and sockets, giving the results in the following form :—

Name of Magazine.	Character and Reputation, as Damp or otherwise.	Nature of Ammunition.	No. of Cases or Barrels opened.	Nature of Case or Barrel.	If securely luted or not.	Condition of Cylinders and Sockets.			Condition of Powder and Serge Bags.			Remarks.
						Fully Serviceable.	Slightly affected by Damp.	Unserviceable.	Fully Serviceable.	Slightly affected by Damp.	Unserviceable.	

3. In the second column the officer will endeavour to furnish full information with regard to the dampness or dryness of the magazine, whether, if damp, it is so at all seasons, or only occasionally; and he will give all the particulars which he may be able to collect as to its temperature at different seasons.

4. If the difference of the temperature between the interior of the magazine and the air outside can be accurately observed at the time of examination it will be stated.

5. Control officers will call on the commanding officer Royal Artillery to detail an officer to conduct the examination of the cartridges in their charge.

\* The 64-pr. 8 lbs. cartridge is not affected, since the paper cylinders have been removed, the charge having increased to 9 lbs. See § 1827, List of Changes.

† These charges are alone recognised for the 7-in. breech-loading guns of 72 and 82 cwt. respectively; any charges exceeding 10 or 11 lbs. should be reduced.

June 1873.

INSTRUCTIONS FOR PROOF OF TUBES, PRIMERS, DETONATORS OF  
FUZES, &c. TO ACCOMPANY THE STANDS PROVIDED FOR THE  
PURPOSE.\*

(To be substituted for the Instructions of 24th June 1872.)

PROOF OF TUBES AND PRIMERS.

1. The stand provided for this purpose is fitted with a copper vent, in two lengths, and a receiver for the powder puff. The first vent represents a vent of 14 inches, with a clear space of about half an inch from the end of it to the puff. The addition of the second part increases the length to 21 inches. All long tubes are to be tested in the 21-inch vent. Tubes for general service in the 14-inch vent.
2. Tubes for 7-pr. gun are to be proved in the special vent, 3 inches long, provided for the purpose.
3. Tubes, detonating, for life-saving rockets, are to be proved by means of the lock provided with the stand.
4. Primers for Armstrong breech-loading guns are to be proved in the special vent provided for the purpose, the 4-inch length at the end of the vent being unscrewed, and the primer inserted in the fixed portion. The distance between the end of the primer and the puff to be 4 inches. The primer is to be fired by means of an ordinary friction or other tube, placed in the vertical portion of the vent. Tubes known to be good should be used for this purpose.
5. Primers for Shrapnel shell are to be proved with the special vent provided for the purpose, 25 inches long; the end of the tube should be enclosed in a box, or in such a manner as to make it quite certain that the powder has been exploded, and not merely blown away. Loose powder is to be used.
6. A failure of 3 per cent. in tubes that have never been issued for service, or of 5 per cent. of tubes that have been issued and returned, will warrant *suspicion* that the tubes are unserviceable.
7. Cylinders of tubes thus suspected, being set aside, one or more will be tested by firing every tube in them.
8. No report of the unserviceability of friction tubes is to be made, or percentage of failures deduced upon a less trial than 100 tubes.
9. Inspectors of warlike stores will keep up their knowledge of the condition of the tubes in their district by obtaining from Commanding Officers of Artillery sample cylinders of tubes manufactured at different dates.† If these samples are unsatisfactory, more cylinders must be opened in order to form a judgment upon their condition.
10. Tubes, quill, friction, *without* loops, should be returned (if in good order) as repairable (to tubes with loops).

PROOF OF THE DETONATORS OF FUZES.

1. Two separate stands are provided for this purpose.
  - a. Is furnished with two upright parallel graduated bars, which admit of a weight being dropped a distance of 25 inches. Two separate weights are provided, one of 7½ oz. for proof of the detonators of the B.L. wood fuzes, and one of 18 oz. for the detonators of Pettman's fuzes.
  - b. Is a small stand for proving the detonators of the B.L. and

\* Diagrams of this apparatus are shown in § 2031, List of Changes, and on p. 76.

† This applies to the small cylinders containing 25 each. Should the tubes be otherwise packed, the inspecting officer will use his judgment as to the proportion to be tested.

of the R.L.\* percussion fuzes with a weight of 1 oz. This apparatus admits of a fall of 15 inches, and when used should be placed on the other detonator proof stand.

2. Before using the stand, care should be taken that the fall is perfectly true; the larger stand has a plumb line attached for this purpose.

3. The detonating balls of Pettman's land service percussion fuzes are proved by allowing an 18 oz. weight to fall upon them through a height of 22 inches. Care must be taken that the bed on which the ball rests, and the striking face of the weight, are cleaned between each explosion.

4. The detonating balls of Pettman's general service percussion fuzes are proved in the same way, the height of the drop being 25 inches.

5. The steady plugs are proved by allowing the weight of 18 oz. to fall through 25 inches on to the brass ball of the fuze placed on the steady plug.

6. The cap detonators of B.L. or R.L. percussion fuzes are proved by allowing a weight of 1 oz., with a sharp point, to fall on to them through a distance of 10 inches, the powder in the pellet being first carefully removed.

7. The detonators of Boxer breech-loading wood time fuzes are proved (without removing the wire) by allowing the  $7\frac{1}{2}$  oz. weight to fall through a distance of 22 inches. To enable the blow to be communicated to the detonator, a small cylinder of metal is provided, which is to be placed upon the hammer of the detonator—the latter having previously been removed from the fuze.

8. The following table gives the details of the different proofs:—

	Weight.	Height.
Detonating ball { Pettman L.S.	18 oz.	22 inches.
{ " G.S.	18 "	25 "
Steady plug - " G.S.	18 "	25 "
Detonator B.L. or R.L. percussion } (with needle point) - - - }	1 "	10 "
Detonator Boxer wood fuze for } breech-loading shell (wire not } removed) - - - }	$7\frac{1}{2}$ "	22 "

9. If a detonator fails the first time, it should be tried a second and third time; but the fact of a detonator requiring more than one blow should excite suspicion.

10. Detonators of fuzes should not be condemned on the trial of a less number than 3 per cent; a failure of more than 5 per cent. of this number is sufficient to condemn them. Care should be taken in reporting the result of the examination to quote all the marks on the fuzes and the cylinders, and to state if the latter have ever been opened. Rule 9 for tubes should be applied also for fuzes.

#### PROOF OF WOOD FUZES FOR B.L. AND M.L. ORDNANCE.

1. Judgment of the state of these fuzes will be formed from the average time of burning of not less than 20; and selection for proof should be taken at the rate of about 2 per cent., from those manufactured about the same date.

\* The "R.L." fuze mentioned in these instructions is that described as "Mark I." in § 2191, List of Changes. Instructions will be issued as to the method of proving Mark II. R.L. fuzes. The violent explosion of the large charge of cap composition renders it necessary to take precautions to protect the operator from the splinters of the cap.



2. In proving B.L. fuzes, the detonators will be removed, and quick match inserted, by which the fuzes can be ignited. (For proof of detonators, *see above*.)

3. Fuzes will be condemned if their time of burning is not within the following limits, viz. :—

The 5 secs. fuze should not reach 5·5 secs., nor burn less than 4·8 secs.			
9 "	"	11·0 "	" 9·7 "
20 "	"	22·0 "	" 19·4 "

Fuzes for S.B. ordnance should be similarly restricted.

4. If fuzes burn irregularly, although their average time may not quite reach the extreme limits, they should be condemned.\*

T. W. MILWARD, Colonel R.A.,  
Supt. Royal Laboratory.

#### ALTERING IRON BURSTERS.

§ 1464, Changes in War Stores, is as follows :—

The following mode of altering such iron bursters for segment shells of 1862 pattern as may remain in store or be in charge of the Royal Artillery has been approved, viz. :—

(1.) One of the wads is pressed into the burster with a wood or copper drift, and the burster emptied.

(2.) The burster is filled with water to destroy any powder that may adhere to the interior.

(3.) One of the metal plugs is removed by the aid of a drift inserted in that end from which the wad was detached; the burster is then reversed and the other plug removed in the same manner, and the interior of the burster cleaned.

(4.) A disc of serge 1 inch in diameter, having fine white paper pasted on one side, is cemented in the interior of the metal plugs; the serge next to the fire hole.

(5.) One of the metal plugs is replaced and the burster filled with powder, the other plug is then inserted, and both plugs fixed by indentations.

Proposed by Superintendent Royal Laboratory.

Recommended by O.S. Committee.

Approved, 24/7/67.

"The cement to be used in attaching the discs of serge to the interior of the metal plugs, as directed in clause 4, of § 1464, is composed of,—  
Spirits, methylated, 1 gallon.  
Gum shellac, 8lbs."

#### DIRECTIONS FOR THE EXAMINATION OF BOXER LIFE-SAVING ROCKET.

Carefully examine the rockets to ascertain whether the case is sound, any which have the slightest appearance of rust upon the case are to be considered doubtful, and minutely examined in the following manner :—

Remove the paint from the part which is rusted, and with the aid of a magnifying glass ascertain whether there is any flaw in the iron. (Sometimes the rust may be due to the contact of another rusty case, and not to any defect in itself.)

This examination of the suspected part to be repeated at the end of three days, and any which have the slightest flaw or crack are to be condemned.

The examination should be repeated periodically, say, every two or three months.

\* Fuzes should in all cases be retained until they are replaced by serviceable ones.

## HINTS ON THE EXAMINATION OF AMMUNITION.

---

The method of examining powder and its classification will be found in the regulations for gunpowder magazines. The "flashing" test is a ready way to ascertain whether powder is of good quality and in good condition. About eight drams of powder are poured on a glass plate so as to form a conical heap and "flashed" by applying a hot iron; no residue should be left, only a few smoke marks should be seen on the plate.

If powder has been much damaged by damp it will be "caked," and a close inspection will generally detect a white appearance due to the saltpetre having been dissolved and deposited in crystals on the surface.

### *Examination of Cartridges.*

The condition of the powder must be examined as above given. Owing to pressure, cartridges which have been tightly packed sometimes feel hard as if the powder was caked, in this case the powder will crumble into its proper condition when handled, and so cannot be confounded with powder which is "caked" from damp.

The condition of the serge should be closely looked to, and any cartridges having holes or traces of being moth eaten should be rejected. Silk cartridges should be examined in a similar manner; they are said to be much less liable to the attack of insects than serge.

The cartridges should be gauged, the choking and hooping should be looked to; the directions as to these operations have been given in the notes. Specially see that the silk cartridges are choked and hooped with silk, and that blank cartridges for B.L. guns are choked with worsted, and service cartridges for B.L. guns with twine. The knots of cartridges for rifled guns require careful examination, as often a slip knot is made instead of a fast one.

### *Proof of Friction Tubes.*

See instructions for proof of tubes, &c: given in the Appendix, p. 266.

The "puff" therein mentioned consists of about two drams of powder enclosed in one thickness of serge. Care should be taken to keep the vents clear, and to ensure their being free from damp a tube should be fired before commencing to test.

Proof of primers for Shrapnel shell. See instructions in Appendix, p. 266.

The primers are ignited by leading quick match through the hole in the cap of the tube provided for firing primers into the cup-shaped recess in the head of the primer.

The proof of primers for vent-pieces and of fuzes, both time and percussion, will be found in the instructions. It is well to gauge the time fuzes as the wood sometimes alters its form; in the case of fuzes of the common gauge having powder channels this is important, as sometimes they are so much enlarged as to bring the side holes above the fuze hole. This can hardly happen with the fuzes of G.S. gauge.

Lights, portfires, &c. can be readily examined by burning, and ascertaining that they burn about the time laid down; if they burn well there is no harm in their burning long.

The primers for lights can be tested at the same time.

### *Examination of Projectiles.*

All projectiles are examined by gauging. S.B. projectiles are so simple, and are so well known in the service, that it is not necessary to give any rules.

Lead coated projectiles should be carefully examined as to the attachment of the lead coatings; in very bad cases the eye will detect a loose coat; and in doubtful cases, tapping the shell with a hammer will detect a loose place, as a peculiar dull sound is given out. The high ring gauge should be passed over the shells, and the lead, if set up, can be filed down.

If blisters appear on the surface they should be pricked, and the lead hammered down.

The fuze hole of shells of garrison calibres should be examined, and any having the Moorsom gauge must be converted by using a G.S. adapter.

The Moorsom gauge is readily known by the large plug with a shoulder and cylindrical body.

The adapter is screwed into its place by the "key, fuze, and plug, G.S.," when screwed home, it fits well down in the socket, about .2" below the top of the fuze hole. The space between the side of the adapter and the iron of the shell is filled by a composition of rosin, 12lbs., Spanish brown, 2lbs., plaster of Paris, 1lb., turpentine, half a pint. The composition is poured in hot, the adapter being closed with a wooden plug.

§ 1583.

In examining Shrapnel shells, R.M.L. or B.L., special attention should be paid to the junction between the head and the body; loose heads may be met with, especially in F.S. Shrapnel of early patterns. A loose head renders the shell unserviceable; also early patterns should be examined to see whether any rosin has worked up into the socket, which would prevent the action of the fuze.

Studded projectiles should be examined by passing the cylinder gauge over them. As this gauge is slightly smaller than the calibre of the gun, a shot which passes the gauge is certain to load easily.

In examining common shells, M.L. or B.L., the condition of the lacquer should be looked to, and also as to whether any loose iron filings may be present in the shell. B.L. shells, with black lacquer, may occasionally be found and prematures may occur when using them. Any loose matter may be detected by "upending" the shell.

Extracts,  
Vol. III.,  
pp. 143-240.

Palliser projectiles are sometimes damaged in transit, if the point is broken off the shell becomes unserviceable. They can, however, be utilized at practice. Any Palliser shot having the base closed with a wedge of wrought iron must be returned for repair as directed in § 2040. All made prior to 1870 require alteration.

See § 1872 for the patterns which do not require alteration.

Case shot are sometimes damaged in transit, or by the jolting motion of a limber. They can generally be repaired by a tinsmith, a little solder is often all that is wanting.

Shells that have been stored in the open air are sometimes found to have admitted water, they should be carefully dried.

Cl. 143, paras.  
32, 33, 34,  
A. C. /69.

Nothing requires more care than the examination of shells returned into store as empty; frequent accidents have happened from the presence of powder in shells so returned; they are therefore received into store

as *doubtful* and carefully examined. At out stations shells so examined are marked with an E in red.

When it is necessary to break up old shells it may be done by placing an iron wedge in the fuze hole and striking it with a sledge hammer. Shell should be washed out with water before this is done.

It is important to remember that projectiles which are not fit for service may often be used for practice; thus shells may sometimes be found so damaged about the bush as to be unfit to use with a fuze, but they can be fired at practice as plugged shell.

*B.L.S.A. ammunition.* By opening the cartridge the state of the powder and the condition of the brass case can be ascertained. **B.L.S. arm ammunition. Examination**

In some of the early patterns, especially in Mark V., the brass may be found to be corroded by the action of the saltpetre on the metal.

The condition of the bullets as to dents and corrosion is rarely important, a bullet may be much knocked about, and still will be found to shoot well.

Firing some targets from a rest will determine whether the cartridges are serviceable.

The Snider cartridge should be condemned\* if it gives a figure of merit over 20 inches when fired at 500 yards in fine calm weather from a fixed rest: where no mechanical rests are provided, a good marksman using a sand bag will be able to fire with sufficient accuracy to test the ammunition.

The Martini-Henry should shoot about five inches better than the Snider.

Missfires are an important defect and should be reported.

Breaking up B.L.S.A. ammunition is an operation requiring great care, the cartridge should be opened with a copper tool, and the powder at once placed in water, on no account should any accumulation of loose powder be allowed on the table. **Breaking up small arm ammunition.**

It is necessary to stir the powder to prevent its floating on the top of the water. In order to prevent risk in transit, the empty cases should be boiled to destroy the cap composition and the powder which is apt to stick to the cases.

*Hale's rockets* should be examined carefully and frequently for rust, especially along the seam and rivets, if the slightest trace is found the rockets are to be repainted, full directions will be found in § 2441, and p. 231. **Hale's rockets. Examination.**

If rockets are very rusty they are probably dangerous, and should be returned to Woolwich. As before pointed out Mark I. is unserviceable.

Rockets of all kinds may be tested as to soundness of composition by entering them head first down the bore of a gun, firing them with a quick-match leader, and noting the time of burning of the composition, and whether any sudden puffs are heard before the end. Times of burning are about the following: 24-pr. Hale, 10 seconds; 9-pr., 8 seconds; Boxer life-saving,  $4\frac{1}{2}$  seconds.

---

\* B.L.S.A. ammunition is not to be condemned without the sanction of the Surveyor-General.

[Issued with Army Circulars, July 1874.]

**REGULATIONS for GUNPOWDER MAGAZINES in charge of the Control Department; including Rules for the Reception, Conveyance, Storage, Classification, and Examination of Gunpowder and Ammunition.**

**I. CHARGE OF MAGAZINES.**

1. At home stations the premises in which gunpowder is stored will be watched by a warder and guard by day, and by a military guard with civil watchman during the night. At foreign stations the civil warders and watchmen are not usually required, the watching being performed by military sentries.

2. The guard will be visited by an Officer by day, and also, when practicable, by night. A copy of the guard's report will be furnished every morning to the Control Officer in charge by the Officer commanding the troops.

3. The Control Officer in charge at home stations will occasionally inspect the police, warders, or watchmen, to see that they are on the alert and doing their duty.

4. The police, warders, watchmen, and sentries will not permit any persons but such as are employed in the service of the Department to enter the magazines or enclosures. All the outer gates will be kept shut, and no artificer, labourer, or other person will be allowed to pass during the working hours without leave from the Control Officer in charge.

5. The police, warders, watchmen, and sentries will not allow any smoking or fire near the magazine, laboratory, or shifting-room, nor will they suffer any person to come within the outer gates who has the least appearance of intoxication. They will immediately secure any one guilty of any of these offences, and report the circumstance to the Control Officer in charge.

6. Any person in the employ of the Department who may be detected smoking in any part of the gunpowder works, magazines, or laboratories, or bringing tobacco pipes or lucifer matches into the premises, will be immediately dismissed.

7. The night sentinels will strike on their respective bells every quarter of an hour; and every sentinel who does not hear the bell next to him struck will report the fact to his Non-commissioned Officer, on being relieved.

8. No shrubs or cultivation whatever will be allowed in or near magazine yards, nor are any animals to have access to them.

9. The Control Officer in charge will not absent himself for a night from the magazines without authority.

10. The Control Officer will superintend all operations which are being carried on by the foremen, labourers, and others under his orders, and see that the whole of the duties are properly conducted.



11. On no occasion will strangers have access to a magazine without the attendance of a Control Officer, or foreman, whose duty it will be to take care that all persons entering have attended to the necessary precautions, and that they have no articles of a combustible nature in their possession.

12. The foreman will be present when the labourers arrive in the morning. He will unlock the door of the magazine, open the shutters, and, when the weather permits, open the windows and air-holes for the purpose of ventilation.

13. The foreman will keep a regular daily entry of all receipts and issues, and make the necessary alterations in the tally-boards attached to the bays in the magazine.

— 14. The foreman will remain at the magazine during the working hours, and on no account leave it, unless ordered to do so by superior authority.

15. The foreman and labourers will always wear during the working hours, in place of their ordinary clothing, the dress prescribed and furnished by the War Department, viz., jacket of lasting cloth, trousers of Oxford cloth, and plain blue Glengarry, to be supplied by the local Control Officer on application. They will change their shoes in the shoe-house and never appear at the magazine in any other than those prescribed by these regulations. [See § 18.]

16. Particular care will be taken that the shutters to the windows or air-holes to the powder magazines and store-house be opened every fine day, subject to the modifications in the Appendix; and when they are open, a person will always be in charge on the spot. All the windows and doors of the magazines will be well secured every evening before the night guard is set.

17. The foreman will close and bar the shutters and air-holes; and on leaving work he will see that everything is secure, lock the doors, and make his report to the Control Officer in charge, with whom he is to deposit the keys.

18. The several persons whose duty obliges them to go into the magazines will invariably exchange their shoes for magazine slippers before they enter, or else enter without shoes. Care will be taken to provide a sufficient supply of either goloshes or slippers of suitable sizes, fitted with straps and brass buckles to fasten over the instep, so as to prevent sliding or shuffling along the floors or platforms.

19. When there is an outer wall to the magazine, the door in it, on any person entering, will be shut before that of the magazine is opened; and the inner door of the magazine shut before the outer one is opened on his going out.

20. The floors of the magazines, shifting rooms, and passages, will be well swept, and kept free from all gravel, sand, or grit; and previous to the removal of powder, the rolling-ways and stages will also be carefully watered.

21. The following regulation contained in paragraph 4 of the enclosure to War Office Circular No. 498, dated 7th November, 1859, has been extended to Home Stations:—

“ In order to secure the best mutual intelligence between departments which in some respects are dependent on one another, and a knowledge of each others wants and resources, it is desirable that the Officer



“ Commanding the Royal Artillery, the Commanding Royal Engineer, and the Controller should, once a year, or oftener if necessary, make a conjoint inspection of the works, magazines, stores, workshops, &c. of all their departments, not as a board or with any view to a joint report, but that neither should have any excuse for not being personally acquainted with anything that the interest of the service requires him to know in the Department of the other, and for the opportunity that would thus be afforded to each of calling attention on the spot to requirements which it may be the departmental duty of the others to know.”

22. Minutes recording these inspections, and any departmental action taken in consequence thereof, will be entered in books to be kept for that purpose by the Officer Commanding Royal Artillery, the Commanding Royal Engineer, and the Controller respectively. The Senior Inspecting Officer will report to the General Officer Commanding, previous to his making his annual inspection report, that such inspections have been made, stating the dates thereof, and also the names of the Officers attending.

## II. PRECAUTIONS AGAINST FIRE.

23. The police, warders, watchmen, and sentries will be particularly attentive to the least appearance of a storm, and on hearing the first clap of thunder or seeing a flash of lightning, though the storm may be at a great distance, they will immediately give an alarm by ringing the bells at their posts ; and the Control Officer, or magazine keeper, as the case may be, on hearing such alarm, will immediately cause all the magazine doors and windows to be shut, and use every precaution necessary for the safety of the magazine.

24. When such alarm has been given, it will be the duty of every person in the employ of the Department, whether on or off duty, immediately to repair to the office to render such services as may be required of him by the Control Officer in charge.

25. The same precautions will be adopted in the event of any fire breaking out in the neighbourhood of the magazines.

26. All the lights on the premises occupied by the foremen, artificers, and labourers attached to the station will be extinguished at half-past ten P.M. ; except in cases of sickness, which are to be reported to the Control Officer in charge.

27. No percussion caps will be kept in any magazine, shifting house, or other building where any manipulation of gunpowder takes place ; but all surplus caps, either loose or in zinc cylinders, will be placed in a secure store by themselves.

28. The fire-engines, engine hose, ladders, fire-hooks, &c. will be kept in perfect repair and so lodged that they may at all times be ready and fit for use.

29. The person in charge of the magazine should know perfectly the arrangement and whereabouts of each article so as to be able to find it at once in the darkest night.

30. The Control Officer in charge will be held responsible that the cisterns are kept constantly full of water, for the security of the magazine, and that the several pumps and lightning conductors are kept in

proper repair and the wells full. Should any of these things become defective, a requisition will immediately be made on the Royal Engineer Department for the repairs to be performed.

### III. VENTILATION OF MAGAZINES.

31. Filled cannon cartridges having been destroyed by mildew in a magazine which had been reported free from damp, the Secretary of State for War directs that particular attention may invariably be paid to the ventilation of all magazines.

32. A memorandum explanatory of the principles on which the ventilation of magazines is to be regulated is printed in the Appendix (*see page 288*). Local instructions based on these principles will be prepared for the guidance of the subordinates in immediate charge of the buildings. Copies of any such instructions will, in each case, be forwarded to the War Office.

33. Each magazine used for the permanent storage of loose gunpowder, to the extent of 100 barrels and over, will be provided with a common thermometer to indicate the temperature of the internal walls.

34. At each station the Control Officer in charge will be supplied with a pair of wet-and-dry-bulb thermometers, for the purpose of observing the dew-points. These thermometers should be placed, when used for observations, in some spot in the open air protected from the sun and wind, and not exposed to any exceptional influences. The scale attached to the dry bulb will indicate the temperature of the external air. The scale attached to the wet bulb will indicate a temperature more or less below that of the air, in proportion to the quantity of moisture which the air contains; except in the case of its being completely saturated, when both scales will give similar readings. It is necessary for the wet bulb to be always supplied with water, and its capillary threads and muslin covering kept in order.

35. By means of the annexed table the dew-point may be ascertained for various degrees of temperature, and when the air is in different conditions with regard to dampness.

36. Whenever, notwithstanding a careful attention to ventilation, magazines are found to be damp, their condition may be improved by the use of quick-lime, which has the property of absorbing from the air about one-third of its own weight of water.

37. The proper time for using lime is when the condition of the magazine would not be improved by ventilation, and when, consequently, the ventilators are closed. Lime would be of very little service while a rapid current of air was passing through the building.

38. Lime will be used during the seasons of the year least favourable for ventilation in all magazines that show signs of dampness.

39. The lime should be fresh from the kiln, broken into lumps not larger than about the size of a pigeon's egg, and exposed to the air of the interior of the magazine in shallow vessels. It should be kept in air-tight casks until spread out for use.

40. The best limes for absorbing moisture are fat limes (which are least valuable for building purposes), such as those produced from white chalk and the non-hydraulic limestones.

41. TABLE showing the Dew-point of the Air at different degrees of temperature, when the reading of the Wet Bulb of the Thermometer is from 1 to 10 degrees below that of the Dry Bulb.

Temperature (Fahrenheit).	Dew-point when the Wet Bulb stands from 1° to 10° lower than the Dry Bulb.									
	1° Lower.	2° Lower.	3° Lower.	4° Lower.	5° Lower.	6° Lower.	7° Lower.	8° Lower.	9° Lower.	10° Lower.
34	31½	28½								
36	33½	31	28½							
38	35½	33½	30½	28½						
40	37½	35½	33½	30½	28½					
42	39½	37½	35½	33½	31	28½				
44	41½	39½	37½	35½	33	30½	28½			
46	44	41½	39½	37½	35½	33½	31½	29½		
48	46	43½	41½	39½	37½	35½	33½	31½	29	
50	48	45½	43½	41½	39½	37½	35½	33½	31	29
52	50	48	46	44	42	40	38	36	34	32
54	52	50	48	46	44	42	40	38	36	34
56	54	52	50	48	46	44	42	40	38	36
58	56	54½	52½	50½	48½	46½	44½	42½	41	39
60	58	56½	54½	52½	50½	48½	46½	44½	43	41
62	60	58½	56½	54½	52½	50½	48½	46½	45	43
64	62	60½	58½	56½	54½	52½	50½	48½	47	45
66	64½	62½	60½	58½	57	55½	53½	51½	49½	48
68	66½	64½	62½	60½	59	57½	55½	53½	51½	50
70	68½	66½	64½	62½	61	59½	57½	55½	53½	52
72	70½	68½	66½	64½	63	61½	59½	57½	55½	54
74	72½	70½	69½	67½	65½	63½	62	60½	58½	57
76	74½	72½	71	69½	67½	65½	64	62½	60½	59
78	76½	74½	73	71½	69½	67½	66	64½	62½	61
80	78½	76½	75	73½	71½	69½	68	66½	64½	63
82	80½	78½	77	75½	73½	71½	70	68½	66½	65
84	82½	80½	79	77½	75½	73½	72	70½	68½	67
86	84½	82½	81	79½	77½	75½	74	72½	70½	69
88	86½	84½	83½	81½	80	78½	76½	75½	73½	72
90	88½	86½	85½	83½	82	80½	78½	77½	75½	74

#### IV. CARE AND STOWAGE OF GUNPOWDER.

42. On the arrival of powder the Control Officer will look to the distinguishing marks on the heads of the barrels, and will arrange them in the magazines so as to keep the barrels of the several lots together as far as practicable.

43. Every barrel, box, or case will be carefully examined, in order to discover whether it be perfectly closed, so that no powder can escape, and whether any of the hoops be fastened with iron nails, or there be any iron or anything objectionable on any part of the barrel, &c. Should any barrel, box, or case be discovered so circumstanced, it will not be received into the magazines, but the powder will be immediately shifted into another barrel or case, and a report made to the Controller. These precautions must never be dispensed with, as fatal accidents have happened from their being neglected. A record of the examination will be made on every arrival of powder.

44. No barrel, box, or case will on any account be opened in the magazine, but, when required, will be taken to a shifting room, which ought always to be provided for that purpose.

45. No barrels containing powder or ammunition will be suffered to lie open in the magazine, and no powder will be shifted from one bay to

another, or otherwise, without a sufficient number of tanned hides or wadmitilts being placed under the barrels, in order to keep the powder as much as possible from the floors ; any loose powder will be carefully swept up, and not suffered to remain. Care must also be taken that all powder barrels are properly and securely stacked in the several bays ; and in case any of the heads of the barrels start, they will immediately be removed, and the powder shifted into serviceable barrels.

46. In the event of the issue of a less quantity than a whole barrel, the package containing it will be marked like the barrel from which it is taken. In the journal of issue, the marks, dates, &c. will be noted as a matter of record.

47. In stacking barrels or cases of ammunition, a space will be left between them and the wall of the magazine, to allow of a free circulation of air and prevent injury from damp.

48. Occasional opportunities will be taken at all stations, (especially where the magazines are liable to damp,) of shifting powder from one bay to another, and opening and re-coopering a few barrels, in order to ascertain if the powder is free from lumps, and to keep the barrels in a serviceable and good state. If in performing this work the powder should be found in any way *lumpy* or *set*, it will be shifted from one barrel to another, the lumps being broken down with the hand as the powder is passed from the barrel to which it belongs to the new one.

49. The practice of periodically rolling about barrels must not be resorted to, as it breaks the grains of powder into dust.

50. Ammunition for breech-loading small-arms which contains its own means of ignition must not be stowed within the same masonry compartments of magazines as gunpowder, whether the latter is loose or in the shape of filled gun cartridges.

51. Control Officers will accordingly take the necessary steps for placing ammunition of this class in separate masonry compartments.

52. Powder, the produce of broken-up breech-loading small-arm ammunition, will not be stored in magazines or used for any purpose, on account of the danger which might arise from a mixture of the detonating composition with it.

53. Such powder will be carefully kept separate, wetted, and reserved for extraction of the saltpetre.

54. Breech-loading small-arm ammunition should not however be broken up without the special order of the Surveyor-General, obtained through the Controller, Royal Arsenal.

55. Powder from all description of shells, whether it has been in bags or not, will be wetted and reserved for extraction.

56. Powder, although called "Shell" in the returns, is not to be condemned unless it actually came out of shells. A great portion of the powder in R.A. charge for filling shells was never in shells at all, while the remainder was issued in flannel bags as bursters.

57. The powder which has been longest in store will always be issued first, except by special order to the contrary. All new powder barrels, when properly seasoned, will be correctly tared, and the weight of the tare marked on the barrel.

58. When any of Her Majesty's ships are returning home from foreign stations, Control Officers will apply to the Senior Naval Officer for permission to land such serviceable powder and ammunition as may be required at the station, and to send home any unserviceable powder and ammunition in exchange.

59. Upon no account whatever are friction tubes, percussion fuzes, or fuzes of any kind that contain their own means of ignition within themselves, to be placed inside any magazine.

#### V. COOPERAGE.

60. All tools, instruments, or other articles used in the magazines are to be made of wood, copper, or bronze, and nothing containing iron, or liable to cause ignition, will be admitted.

61. The use of iron rivets to copper hoops of the description used for powder barrels, whether loose or otherwise, is forbidden, even if those hoops should be intended to be applied in the first instance to barrels not containing powder, as they are liable to be afterwards transferred to such as may contain it.

62. To prevent any inconvenience to the service that might arise from the want of proper rivets necessary to replace those which may break Control Officers at all stations will keep a small store of copper rivets, sufficient for that purpose, and make timely demands for such as they may require.

63. The pieces of wood forming the heads of powder barrels will be put together with wooden pins, and in no case will iron be used.

64. In heading and unheading powder barrels, the persons employed will never use the bare adze against the copper hoops, but will invariably apply a wooden-handled metal setter.

65. Whenever it may be necessary to shift gunpowder from one barrel to another, the barrel intended to receive such powder will first have all the marks, except the tare on it, carefully obliterated, and will then be re-marked with precisely the same marks as the barrel from whence the powder is transferred, with the exception of the tare marks.

66. Nails will on no account be used to fasten on the hoops in re-heading powder barrels.

67. Powder barrels, either for stowage or issue, will contain 100 lbs. each, except in the case of "P" powder, of which each barrel contains 125 lbs. The quantity of powder in cannon and small-arm cartridges will be calculated accordingly.

#### VI. EXAMINATION AND CLASSIFICATION OF GUNPOWDER.

68. The examination of gunpowder in store will be conducted by Inspectors of Warlike Stores and other Proof Officers, in the following manner :—

69. About one-fifth part of the whole quantity in store will be tested annually ; of this fifth, one in every 20 barrels, selected indiscriminately, will be examined. In the second year the same course will be pursued with reference to another fifth of the store, and so on until the whole shall have been examined, when the process will be repeated.

70. The barrels actually examined will in each case be marked, and other barrels will be selected when the same lot again comes under examination.

71. The examination of powder will be confined to an inspection by sight and hand, for the purpose of testing its qualities in the following points :—

1st. As respects the condition of the grain, which should be firm, crisp, and bright in colour.

2nd. As regards freedom from dust and foreign matters.

This latter point will be ascertained by pouring the powder from a bowl held 2 or 3 feet above the barrel.



72. The firing proof, by means of the Eprouvette Mortar, will cease.

73. If the examination be in all respects satisfactory, and there be no sign of deterioration, the powder may be placed in class I.

74. Any portion of *Service* powder found on inspection to be unmistakably dusty or broken in the grain may at once be reduced to an inferior class.

75. Exceptions to this rule will, however, be made in the case of R.F.G., R.F.G<sup>2</sup>, and R.L.G. powders, which, if only dusty, will be redusted and restored to the 1st Class.

76. In cases that admit of doubt, the report of the examination will be transmitted through the local Controller to the Superintendent, Royal Gunpowder Factory, before the powder is reduced from the service class; but if urgently required for service it may be issued.

77. *Service* powders include all descriptions used for firing projectiles, whether from cannon or small arms. *Serviceable* powders include service, blank, and shell powders.

78. After examination, gunpowder will be classified and marked according to the following table; and if repaired, the barrels will be especially distinguished (*see* § 87), in order to ensure their being issued before gunpowder in a less deteriorated condition. Re-examination will be noted in like manner with date.

Class.	Designation.	Description.
I.	Service - -	1. All new powder. 2. All returned powder (including cannon cartridges) which, on examination, may be found uninjured.
II.	Blank - -	1. Powder from broken-up cannon cartridges, unless specially placed in Class I. 2. Powder from broken-up S.A. ammunition.* 3. Service powder found dusty or broken in the grain at periodical inspections, or on return; except in the cases of R.L.G., R.F.G., and R.F.G <sup>2</sup> powders, which if only dusty will be re-dusted for service.
III.	Shell - -	Powder found too dusty for Class II.
IV.	Doubtful - -	All powder whatever (except new powder) returned into store, and awaiting examination.
V.	Condemned for sale.	Powder found on examination to be too much deteriorated to be placed in any of the above classes.
VI.	Condemned for extraction.	Powder obtained from shells, and powder found to have been so much damaged as to be unfit for any purpose but extraction of saltpetre.

79. Powders found on examination to be repairable will at once be marked with the class to which they are capable of being converted; but will be crossed in white chalk, in order to indicate that they are only equivalent to a *doubtful powder* in an issuing point of view.

80. At home stations all powder returned into store will, in the first instance, be placed in Class IV.; it will be removed to one of the other five classes on the result of the inspection being determined. At stations where conveniences for local examination may exist, a requisition will be made by the Controller to have this inspection made without delay. If circumstances should render such a course impracticable, the gunpowder

\* Powder obtained by breaking up breech-loading small-arm ammunition is to be at once thoroughly wetted, as it may contain small particles of detonating composition. In this state it is useless except for extraction of saltpetre, and will therefore be placed in Class VI.



will be retained as "*doubtful*," and a report of the circumstances made to the Controller, Royal Arsenal, Woolwich, who will convey the orders of the Surveyor-General in the matter.

81. At foreign stations the examination of powder will be conducted by the Proof Officer, on the requisition of the Control Officer. The examination will be made as soon as possible after delivery into store, in order to enable the Commissary to assume charge of the gunpowder in accordance with its existing state and condition.

82. At stations where no artillery are located, the Commissary will personally examine all powder contained in the original packages as soon as received into store. If no sign of deterioration present itself, he may assume charge of the powder under its original classification, and may re-issue it accordingly; but should there be any reason for doubt, the powder will be taken in charge and marked as under Class IV., and the circumstances reported to the Controller, Royal Arsenal, Woolwich, who will communicate the order of the Surveyor-General.

83. Powder from broken up cartridges, will in all cases be sifted *before* being returned into store, so that all extraneous articles may be detected.

84. The sizes of sieves used in sifting powder before returning it into store will be as follows :—

For R. L. G. powder, a sieve of 3 meshes to the inch.

L. G.	"	"	6	"	"
R. F. G. & R. F. G <sup>2</sup> .	"	"	8	"	"
F. G.	"	"	12	"	"
Pistol	"	"	16	"	"

85. On receiving powder, Commissaries will look to the distinguishing marks showing the description of powder, maker's name, and grains or dates of stoving; and will arrange the barrels in the magazine accordingly, carefully keeping the powder of each date of stoving together as far as practicable.

86. In issuing service powder, care will be taken to issue, as far as possible, the powder of the same maker, and of the same brand or stoving.

87. The annexed examples will show the manner in which the heads of barrels will be marked in future.

No. 1.

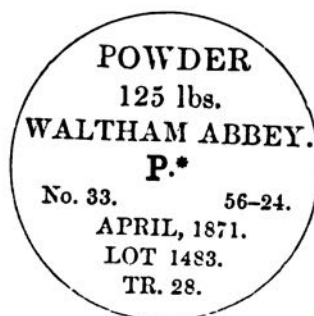

\* This letter will be in red paint.

281

No. 2.



No. 3.



No. 4.



No. 5.

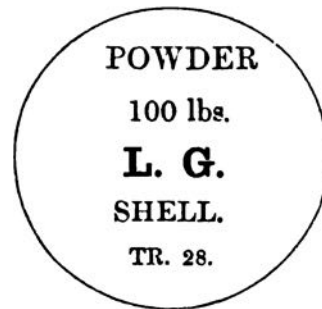

---

\* These letters will be in red paint.

† Or "Repaired," as the case may be.

88. No. 1 applies to new powder.  
 No. 2 applies to returned powder, which, after examination, has been classed for service.  
 No. 3 applies to returned powder, which, after examination, has been re-dusted or otherwise repaired for service.  
 No. 4 applies to blank or exercise powder.  
 No. 5 applies to shell powder.

The 5th line in No. 1 contains :—

1. The brand of powder (No. 33).
2. The number of barrels in the brand (56).
3. The number of the barrel itself in the brand (24).

89. Gunpowder is divided into lots for convenience of storing ; each of the 100 barrels composing a lot is marked with the same number, and the numbers of the lots run consecutively for each manufacturer, as powder is supplied.

90. The following list shows the purposes for which powders of the several descriptions are to be used ; and demands and issues will be regulated in accordance therewith.

*P.* For the *battering* charges of all rifled guns of 7-inch calibre and upwards, and for all service charges of 40 lb. and upwards. When no *P.* powder is available *R.L.G.* will be used.

*Service R. L. G.* For service charges to the Royal Navy of 9, 8, and 7-inch M.R.L. guns ; also for *battering* charges of all guns when *P.* powder is not available, and for R.M.L. field artillery.

*Service L.G.* For all service charges with R.M.L. land service garrison guns under 10-inch, and S.B. ordnance ; for R.M.L. sea service, 80-prs. and under, and R.B.L. guns. The 7-pr. M.L.R. gun, however, is an exception, for which F.G. is used for land and sea service.

*Service R.F.G.* For rifled small-arms of every description except Martini-Henry rifle and pistols ; for 7-pr. M.L.R. gun, and for the bursting charges of Shrapnel shell when F.G. is exhausted.

*Service R.F.G.<sup>2</sup>.* For Martini-Henry rifle.

*Service F.G.* For 7-pr. M.L.R. guns, for all smooth-bore small-arms, and for the bursting charges of Shrapnel shells.

*Service Pistol.* For Colt's, and Dean and Adam's cartridges, and for bursting charges of Shrapnel shells.

*Blank, or Exercise R.L.G. and L.G.* For blank charges (including the reduced charges of 9, 8, and 7-inch R.M.L. guns when issued to the Royal Navy) of all descriptions of rifled and smooth-bored ordnance.

*Blank, or Exercise R.F.G., R.F.G.<sup>2</sup>, and F.G.* For blank small-arm cartridges of every description. These powders may, if it be considered advisable, be used for blank charges for ordnance when there is a surplus store.

*Shell Powder.* L. G. for the bursting charges of all shells, rifle or smooth-bore, except Shrapnel (see above), and 6, 9, 12, and 20-pr. segment shells, for which F.G. is to be used, or R.F.G. when the stock of F.G. is exhausted. F.G. or L.G. in Class II. may be taken if no F.G. or L.G. in Class III. be available, and service F.G. or L.G. if no blank F.G. or L.G. be available.

91. *Service* powder will never be issued for *blank* or *exercise* cartridges, when any powder classed under the latter head is available. This rule is intended to apply strictly to the non-issue of service R.L.G., R.F.G. and R.F.G.<sup>2</sup>. powders for blank charges. Exercise powder will not be issued for filling shells, when shell powder is available.

92. The Proof Officer will be careful to note at his issuing and receiving examinations, the numbers of the lots, as also the marks and

dates that have been placed on the various barrels of powder submitted for his inspection, before being issued to, or on being received from Her Majesty's Land or Naval Forces. All these particulars will be entered in the report made to the Commissary, in order that they may be available for future reference in case of necessity.

#### VII. LABORATORY OPERATIONS.

93. The following instructions will be strictly observed by all persons engaged in work connected with combustible stores.

94. When any laboratory operation, such as making up ammunition, removing fuzes, and filling or emptying shells, is required to be performed, the Commissary in charge will inform the Controller. The Controller will then report the same to the General Officer Commanding, who will direct the Commanding Officer of the Royal Artillery to take steps for the performance of this duty.

95. These operations will be carried on in accordance with the following extract from the Queen's Regulations, 1868 (Para. 664). The detailed application of these instructions must depend upon the means available at each station.

"(a.) No laboratory operations which involve risk of an explosion is to be carried on within a distance of 400 yards, from a magazine in which large quantities of gunpowder are stored.

"(b.) No accumulation of gunpowder or other explosive material is to be allowed on any account in the workshops, or in close proximity to the laboratory buildings. A small expense magazine in a safe position is to be provided, the stores are to be drawn from this magazine in small quantities as required, and the finished work is to be returned to the magazine in the same way. This is a most important point, for notwithstanding every precaution an accident may occur.

"(c.) All the arrangements should therefore be made with a view to reduce as far as practicable the amount of explosive or combustible material in a building at any one time, where laboratory operations are being carried on.

"(d.) The destruction of combustible stores by fire, or by breaking up, is on no account to be effected within the precincts of a laboratory.

"(e.) All persons engaged in work connected with combustible stores are to change their outer clothes, viz., coat, waistcoat, trousers, cap, and shoes, and to wear suits specially provided for this purpose.

"(f.) The change of clothes is to be effected in a shifting house, where the ordinary clothing is to be deposited.

"(g.) Only steady and intelligent men are to be employed on laboratory work, and the preference is to be given to those who have passed through a course at Woolwich."

96. In removing fuzes from shells only such tools as are provided for this purpose will be used, and with respect to the pillar fuze especial care will be taken not to press unduly upon the head on account of its very close proximity to the detonating composition.

97. To reduce the risk in extracting pillar fuzes as far as possible, a special extractor will be supplied.

98. In cases in which the fuze will not yield to the authorised means of extraction, the shell, if not provided with an unloading hole, will be placed under water, *and in this condition*, namely, *under water*, a small hole will be bored through the side for the admission of water. The powder will be thoroughly saturated before any further steps are taken to remove the fuze. The shell will then of course be condemned as unserviceable.

99. When this operation cannot be conveniently performed, the shell will be thrown into the sea, or otherwise safely disposed of.

100. If the shell has an unloading hole, the unloading hole plug will be unscrewed, the papier mâché wad forced into the interior, and water poured in until the powder is thoroughly saturated.

101. The operation of removing the fuze from the shell will be performed in a separate building, and in the absence of special reasons to the contrary, only one shell will be operated upon at a time.

102. When the fuze is removed a service metal fuze hole plug will be screwed in to secure the powder, and the shell then conveyed to another building to be emptied.

103. To empty the shell a wooden frame or cradle will be used to rest the shell upon, and the greatest care will be taken that every portion of the bursting charge is removed before the shell is returned into store as empty, water being used to wash out any trace of powder which it may be difficult to remove with the copper scraper.

104. Shells thus emptied will be marked on the head with an **E** in yellow paint at Woolwich, and red paint at other stations, also with a letter to denote the stations. The powder obtained will be treated as directed in paragraph 55, and in general any powder which during laboratory operation, has been spilt on the floor, or otherwise exposed to admixture with iron filings, grit, or dirt of any description, will be at once swept up, wetted, and reserved for extraction.

#### VIII. CONVEYANCE OF AMMUNITION AND GUNPOWDER BY LAND.

105. No ammunition or gunpowder will be sent to any station at home until the officer who has to receive it has been communicated with by the officer who has to make the supply, and the consignee has replied that he is prepared to receive it.

106. At the time the issue is made a proper invoice will be sent to the consignee.

107. When small-arm ammunition or gunpowder has to be removed by the troops in their own wagons, or in the wagons, belonging to the War Department, a requisition will be made on the General or other Officer Commanding the district or garrison, by the officer in charge of the depôt, stating the number of wagons required, and the day on which the ammunition or powder will be ready for removal. It will be left to the Officer Commanding the Troops to fix the day and hour on which the ammunition or gunpowder shall be removed.

108. At the time and place appointed a Control Officer or a Sergeant Conductor will be in attendance to hand the packages over to the Officer Commanding the party. Should wadmiltits be required for the security of the ammunition they will be lent to the military party, and the Control Officer will take care they are duly returned when the service has been completed. In order, however, that there may be no divided responsibility, it is to be clearly understood that the Officer in command will be responsible for the due delivery of the packages, as well as for the wagons being in all respects suitable, properly stowed, and not overladen.

109. When large quantities have to be forwarded, otherwise than by military conveyance, the Control Officer making the issue will take care that the contractor by whom the packages are forwarded, provides proper conveyance for the same; that the carts or wagons are not overladen; and that they are properly secured both from danger and damp, and for this object wadmiltits and hides may be lent to the contractor on the same terms laid down in § 108.

110. As all ammunition and gunpowder sent by railway is placed in properly constructed powder vans (except when secured in iron safety cases, as alluded to in § 113), no further precautions against danger are necessary, the railway authorities and contract carrier being respon-



sible ; but the contract carriers will have to see that the packages are handed over to the railway officials in proper order and condition. They will have also to make all arrangements with each railway company for the due forwarding of the ammunition or gunpowder, without delay, after receipt at the station, and will, therefore, have to give due notice to such company of the day and hour on which it is to be forwarded. The contract carriers will further be responsible, that, when the ammunition reaches the railway station, proper conveyances are at hand to convey it to its final destination.

111. Volunteers and other corps may draw their own ammunition and convey it to their own magazines, the officer in charge of the depôt taking care that the conveyances are in all respects suitable and are not overladen. Wadmiltits may also be lent on the terms laid down in § 108.

112. In the absence of special orders from the War Office, escorts will not be required to accompany the ammunition or gunpowder, unless the General or other Officer Commanding the district or garrison considers it necessary, and in the event of such being the case, he will duly inform the Control Officer, who will in such a case, invariably apply to such Officer for the proper escort, stating in his application the quantities of ammunition or gunpowder to be forwarded, by what conveyance to be sent, as also the day and hour fixed for its departure. It will be for the Officer Commanding the troops to determine the strength and description of the escort required.

113. In the conveyance of small quantities of small-arm ammunition by railways in the United Kingdom, in order to expedite issues to regiments, and also to reduce the expense of the employment of powder vans, *metal cylinders* adapted for containing half and quarter barrels will be used.

114. These cylinders will be conspicuously marked with the name of the station to which they belong, and with the letters W ↑ D, and will be held on charge as articles in use, notwithstanding their being sent away from time to time with ammunition.

115. Commanding Officers, and others, will immediately on receiving these cylinders, empty and return them, with the spanners and bags, to the Control Officer at the station from which they are sent, by the same mode of conveyance by which they arrived.

116. Every instance of unnecessary delay in the return of the cylinders, &c., will be immediately reported by the Commissary in charge to the Controller.

#### IX. CONVEYANCE OF AMMUNITION AND GUNPOWDER BY DEPARTMENTAL VESSELS.

117. On arrival at any control station, the Master of the vessel will immediately report himself to the Control Officer, and, if any stores are on board, deliver the bills of lading.

118. The Master will keep a log book, inserting the daily occurrences, and also the receipts and deliveries. The tally of all stores passing into or out of the vessel will be taken by the master or mate, who will be held strictly accountable for the delivery of all the stores, according to the receipt tally, and any deficiency must be immediately reported by the Control Officer to whom the stores are consigned.

119. The Master will attend daily at the Control Office at the station where the vessel may be lying, to receive such orders as the Control Officer may find it necessary to give. The Master will receive his instructions from the Control Officer only.

120. The Master will frequently examine the hold, and be particularly careful that all iron bolts, nails, &c., are covered with sheet lead or



tanned hide, and that any defects in the vessel or stores are immediately reported, in writing, to the Control Officer at the station.

121. Previously to receiving any gunpowder, ammunition, &c., the master or mate will take especial care to examine the hold, and see that it is clean swept, free from grit or dust, and in a fit state to receive the stores. He will report the fact to the Controller.

122. As a general rule, no combustible stores will be conveyed in the same hoy with powder and ammunition. In special cases, however, where combustible stores of an unexceptionally safe description are forwarded, with proper precaution as to their stowage and security, this restriction may be omitted.

123. On receiving gunpowder, ammunition, &c., the Master will see that the platform in the vessel's hold, the gangways, and comings of the hatchways are covered with tanned hides, that the barrels or boxes are carefully stowed, the hatches properly secured and locked, and that the key remains in his own possession.

124. A cushion (stuffed with white oakum) covered with leather, will be used for landing all powder barrels or cases upon, whether in the hold of the vessel or on the wharf, when loading or discharging powder.

125. In stowing powder in the hold of the vessel the barrels will be carried, and on no account rolled over each other, unless tanned hides are laid down for the purpose of protection.

126. No leaky or badly coopered barrel will be received on board, and should such be offered, the Master will refuse to receive it, and will report the circumstance to the Control Officer in charge at the station immediately.

127. After the vessel has been discharged, the hides, hair-cloths, &c., will be removed, and the hold carefully cleaned out.

128. On delivery of the above-mentioned stores the same caution will be used as in loading, and if any barrels or boxes should have been unavoidably broken, any powder which may have become loose will be carefully swept up, and the circumstance reported by the Master to the Controller before delivery to the magazine.

129. No fires, other than the engine-room fire, will be lighted on board any vessel, barge, or craft conveying gunpowder, or combustible stores, to any place in the River Thames within one mile below Gravesend, or in either of the canals leading to Aldershot or Weedon; nor between the Nore and Chatham in the River Medway; nor within two miles of the Spit, or outer Buoy, leading to Harwich Harbour.

130. When gunpowder or ammunition is shipped, and the vessel is within the limits of *any* port, neither fires, lights, nor smoking will, under any circumstances, be permitted on board.

131. Fires will be provided in the cook houses at the several stations, when requisite, for cooking the provisions.

132. When at anchor at night in a roadstead, or in the track of shipping, a masthead light will be shown, and when under weigh the side lights, according to Admiralty Regulation.

133. When the vessel, barge, or other craft is one mile below Gravesend, and not nearer than half-a-mile of any inhabited place or magazine, a fire may be lighted on board for cooking purposes only, and the master will see it carefully extinguished at sunset, and one hour previously to going alongside any ship or magazine. The engine-room fires in the steamers must also be put out one hour previously to going alongside any ship or magazine.

134. Smoking below is strictly prohibited.

135. When a vessel has received gunpowder, ammunition, or combustible stores on board, a red flag will be hoisted at the mast-head, and kept flying until the cargo is discharged. The Master or mate and all the crew will remain on board until all the stores are discharged, unless it may be necessary to procure water or provisions, in which case notice will be given to the Control Officer, but the vessel is not to be left without either the Master or mate and one seaman.

136. No lucifer matches will at any time be used on board any of the War Department vessels, and any person found to be in possession of the same will be immediately dismissed. The usual tinder-box, &c. will be kept by the Master, and used for the purpose of striking a light when actually necessary.

137. At Priddy's Hard, Purfleet, and Tipner, and at No. 1 and 2 Magazines attached to the Royal Arsenal, when in consequence of want of water, a vessel laden with powder or combustible stores is unable to be unloaded on the day of arrival, she will be moored in the safest position at the wharf, and the hatchways secured and covered with tarpaulins; and no other vessel will be allowed alongside of her. At all other stations the vessel not unloaded will haul into the stream a distance of 900 yards from the Magazine Wharf, but if empty a distance of 400 yards is sufficient.

138. No vessel having powder or ammunition on board will be left without a responsible watchman in charge.

#### X. GUNPOWDER VESSELS.

139. The following regulations for receiving powder and ammunition are for the guidance of persons employed on board the Store Department vessels and in the Laboratory craft used for the conveyance of the same to and from the receiving vessels, &c. :—

140. All persons employed in the receiving vessels, barges, boats, and magazines, will change their outer clothes, viz., coat, waistcoat, trousers, cap, and shoes, and wear the suits specially provided for them.

141. The change of clothes will be effected in a shifting house, where the ordinary clothing will be deposited.

142. Smoking is strictly prohibited, and any man found with a lucifer match in his possession will be immediately dismissed.

143. No fire is on any account to be allowed either in the receiving vessels, barges, or boats.

144. The receiving vessels, barges, and boats will be kept scrupulously clean, and free from loose gunpowder.

145. In shipping or unshipping ammunition or gunpowder, tanned hides or wadmiltits will be laid over that portion of the vessel over which the cases or barrels pass.

146. A red flag will be kept flying when there is any gunpowder or ammunition on board the receiving vessel.

147. At Woolwich the gunpowder will be received daily from the receiving vessel at the lower causeway, and transported in railway trucks to the Royal Laboratory; the made-up ammunition will be transported in railway trucks from the East Laboratory to No. 1 Magazine, each truck being laden by the Laboratory and handed over to the Control Department for removal.

148. Gunpowder or ammunition required to be sent from the Arsenal, by land carriage, will be brought from No. 1 Magazine in trucks to within the walls of the Arsenal, or if immediately required, will be handed over by the Royal Laboratory to the Control Department on the bank of the canal.

149. The suits of clothing provided for and required to be worn by the persons employed in the receiving vessel and Laboratory barges are as follows:—

In Summer.	In Winter.
Cap.	Cap.
Lasting jacket.	Lasting jacket.
Cloth trousers.	Cloth trousers.
Woollen shirts.	Woollen shirts.
Shoes, magazine.	Woollen drawers.
	Great coat.
	Shoes, magazine.

The persons employed must provide themselves with woollen shirts and drawers.

JOHN ADYE, Brig.-Gen.,  
Director of Artillery and Stores.

---

## APPENDIX.

---

### MEMORANDUM RESPECTING THE VENTILATION OF MAGAZINES.

1. The dampness complained of in buildings will frequently be found to arise from condensation of the watery vapour of the air which enters the building. Buildings with thick walls and vaulted roofs, and especially those covered with earth, are particularly liable to dampness from this cause.

2. Air always contains some proportion of watery vapour. When the proportion is small the air is said to be dry, and when large the air is said to be damp; when the proportion is the greatest that can be diffused through air at a given temperature, the air is said to be saturated at that temperature.

3. The proportion of watery vapour which saturated air contains varies with the temperature, being greater for high than for low temperatures. Air containing a particular proportion of moisture is rendered less capable of depositing moisture by its temperature being raised, and the reverse when it is lowered.

4. Air may be brought to a state of saturation by reducing its temperature. If the air contain but little moisture, the reduction of temperature must be considerable; but if it contain much a slight reduction will bring it to a state of saturation.

5. If air be cooled below the degree of temperature at which it will be in a state of saturation, a portion of the watery vapour contained therein will be deposited on any cold substance with which it may come in contact. The degree of temperature at which air will thus begin to deposit moisture is called its *dew-point*.

6. When warm air enters a comparatively cold building the temperature of the air is reduced by coming in contact with the interior walls and other cold surfaces: and if its temperature be thus reduced below the *dew-point*, condensation will take place. In the latter case it is obvious that the admission of fresh air will not tend to dry a building, but to render it damp.

7. If a magazine, 40 feet by 24 feet by 12 feet, the temperature of whose internal walls, &c. is 45 degrees, were to be filled with saturated air having a temperature of 50 degrees, and the magazine were then closed, nearly a pint of moisture would be deposited during the cooling of the fresh air to the temperature of the walls. The pint of moisture would result from the quantity of air sufficient merely to fill the magazine; but if the ventilators were open, the air might be renewed many times in the course of a day, and very much more than a pint of moisture be deposited.

8. Air entering a building, whose temperature is higher than its own, becomes capable of absorbing moisture from damp surfaces.

9. The efficiency of the ventilation of a magazine will depend upon the degree of dryness which the fresh air admitted into it possesses, and the rapidity of the current of dry air passing through the building.

10. The dryness of air is indicated by the number of degrees by which its temperature exceeds its dew-point.

11. The ventilators of magazines should, in all cases, be constructed so as to exclude or admit the external air at discretion, *and the instructions for their use should be framed with a view to the exclusion of the external air, when the temperature of its dew-point is above that of the interior of the building, and the admission of the air when its dew-point is below the temperature of the interior of the building.*

12. For the foregoing reasons, the common practice by which, under Art. 491, Ordnance Regulations, 1855, magazines are open for purpose of ventilation on "every fine day," is considerably modified.

13. The interior of a bombproof magazine with thick walls and a vaulted roof is commonly colder than the outside air in summer and warmer in winter. Winter is therefore the more favourable season for ventilation; but in the climate of England the exceptions to this rule are numerous, owing to the prevalence during winter of warm damp winds from the south and west, and during summer of cold dry winds from the north and east.

---

[Issued with Army Circulars, dated June 1873.]

#### GENERAL INSTRUCTIONS for the GUIDANCE of the ROYAL ARTILLERY in CHARGE of MAGAZINES or AMMUNITION STORES.

1. No one will pass the barrier at the entrance of a magazine or ammunition store except in the presence of the Officer, Master Gunner, or Non-commissioned Officer in local charge of the building, who will be responsible that all persons entering comply with the necessary precautions, and that they have no articles of a combustible nature in their possession.

2. All persons employed in magazines, cartridge stores, and in shell stores when connected with cartridge stores, will, before entering the same, change their own clothes and boots for magazine clothing and slippers. This will be effected in the place appointed for shifting, where the boots and clothing taken off will be deposited.

3. Smoking is strictly prohibited near any magazine or ammunition store, and any soldier entering them with a pipe or lucifer match in his possession will be made a prisoner.

4. Only the hand magazine lantern will be used within the magazine or ammunition stores, and then only in the presence of the person in actual charge.

5. Laboratory operations will not be carried on in any magazine, cartridge, or shell store, or in any of the passages connected therewith, but only in the building, or tent, specially provided for the purpose (*vide* Regulations for Laboratories).

6. Every favourable opportunity will be taken for airing the magazines on the principles given in the memorandum attached. Common thermometers will be issued to all magazines containing 100 barrels and upwards of loose powder.

7. Magazines will never be left open unguarded, and sentries will be particularly attentive to the earliest appearance of a storm, however distant, and upon hearing thunder, or seeing a flash of lightning, they will give the necessary notice, in order that the doors and ventilators may be immediately closed.

8. The floor of a magazine or ammunition store will be kept scrupulously clean and free from loose grains of powder. The passages will be covered with hides, wadmiltits, or hair cloths, when powder in bulk is being moved; these coverings should be frequently lifted and dusted.

9. Barrels, cylinders, and cases will be placed so that the air can circulate freely round them. They should be at least six inches from the masonry of the building.

10. No packing or shifting of cartridges, or issue of powder from cases or barrels, will be permitted within the block containing the magazine or cartridge stores. These operations will only be carried on in the Laboratory.

11. No friction, detonating or common tubes, fuzes, quick or slow match, signal lights, rockets or primers will be kept in any magazine or cartridge store, or admitted within the enclosure of a magazine where gunpowder alone is stored. Tubes and fuzes may be kept in the shell stores.

12. Small-arm ammunition, which contains its own means of ignition, will not be stowed in the same chamber of a magazine with gunpowder, whether the latter is loose or in filled cartridges.

13. Oiled rags, cotton waste, oakum, or cloths for cleaning, are not to be kept in magazines, ammunition stores, or their passages.

14. All boxes, cases, and barrels placed in magazines or ammunition stores will be labelled, and no empty boxes, cases, or barrels will be allowed to remain in them. Barrels containing powder will never be rolled along the floors of magazines or passages, but will be carefully transported from one place to another.

15. Officers, Master Gunners, and Non-commissioned Officers in charge will at all times be particularly careful with everything in or about the magazines, and will take immediate notice of any irregularity they may observe. They will also be very prompt in reporting any defects or repairs necessary either to the interior or exterior of the buildings.

16. An inventory board, showing the contents of the magazine or ammunition store, will be hung up in the lobby or passage leading thereto.

17. The keys of the magazines and ammunition stores will be labelled, and when not in use deposited in a secure place.

18. A copy of these instructions attached to a board will be hung up on the inside of outer doors and on the wall of the entrance to the magazines. Copies for this purpose, printed on foolscap paper, can be obtained on demand.

19. W. O. Form 939 (Standing Orders for Artillery Magazines, dated Horse Guards, 1st December 1865) has been cancelled.

H. K. STORKS.

*[Memoranda respecting the ventilation of magazines are appended, for which see page 288.]*

---

*[Issued with Army Circulars, dated June 1873.]*

**REGULATIONS to be observed in MAKING-UP CARTRIDGES,  
FILLING SHELLS, and EXAMINING AMMUNITION in  
LABORATORIES in ARTILLERY CHARGE.**

1. By the term "laboratory" is meant the block of buildings (with the passages and ways leading thereto) in which the examination of all ammunition will take place, cartridges made up, and shells filled. In most works suitable buildings for the purpose have been erected, consisting of a lobby with barrier at the entrance, and filling room for shells or cartridges, with hatches or openings for the admission and delivery



of powder or filled cartridges and shells. Where no laboratory building exists a tent will be used.

2. Laboratory operations will be carried on under the superintendence of an officer, who must satisfy himself that the several men, as detailed in § 3, understand the duties entrusted to them. The presence of an officer will not, however, be necessary at small detached forts or batteries in charge of master gunners where ammunition is made up for the auxiliary artillery.

3. The party for laboratory operations will be detailed as follows:—

Two men as magazine men, to issue powder in barrels from the magazine, and receive and stow cases or cylinders containing made-up cartridges.

Four men for conveying the powder barrels and cases with cartridges or filled shell to and from the laboratory. Two men will be sufficient if only one barrel of powder, or less, be required.

Eight men for the cartridge or shell-filling room, or less, if a small quantity of ammunition is to be made up. These men will be detailed to unhead the barrels, weigh out charges, make up cartridges or fill shells, as may be required.

Two men will be required at the entrance or receiving hatch, to pass in empty shells.

4. The men engaged in the laboratory will exchange their clothing and boots for laboratory clothing and slippers, in the place provided at the entrance, and will on no account re-pass the barrier without again changing their clothing.

5. Previous to being told off, the men must be warned to lay aside any knives, pipes, matches, or combustibles they may have about them. Any infringement of this rule will be dealt with as *disobedience of orders*.

6. The operations of filling shells and making-up cartridges will never be carried on at the same time in the same room or tent.

7. The greatest attention will be paid to cleanliness in all parts of the laboratory and ways leading thereto; also in the wagons and barrows used for the conveyance of the powder or ammunition to or from the laboratory. Any loose grains of powder, dust, or grit will at once be swept up.

8. No barrow, tool, or tackle used outside will be admitted within the barrier at the entrance of the laboratory.

9. Nothing will be kept inside the barrier of the laboratory but the authorised articles for a laboratory, a proportion of clothing, also a supply of zinc cylinders for cartridges, which must be thoroughly examined previous to admission.

10. The shells to be filled will be piled on old shot or stone, outside the entrance to the laboratory or hatch, lettered "For admission of shell," if there be one. The shells will be thoroughly cleaned and brushed externally before being passed into the laboratory—planks being laid down when the heavier shells are filled, in order to save the floor.

11. All shells, previous to filling, will be carefully searched internally, and all loose filings or pieces of lacquer removed.

12. All shells, up to the 9-inch inclusive, can be *up-ended* by hand on the blocks, for examination and filling. Heavier shells require the tackle and strap.

13. Made-up cartridges or filled shells will on no account be issued by the same door or hatch through which the loose powder or empty shells are passed in.



14. Powder barrels will be conveyed to the laboratory, and zinc cylinders containing filled cartridges to the magazine or cartridge store, in barrows, in order to keep them free from dirt or grit.

15. The floor of the chamber in the laboratory, appropriated as a filling room, will be covered with hides when in use.

16. Empty powder barrels will be passed out at once, and stored in a clean place; and in the event of a barrel not being emptied, it will be re-headed and returned to the magazine.

17. Not more than the equivalent to two barrels of powder will be in the laboratory, or in transit between the magazine and laboratory, at the same time.

18. A copy of these instructions attached to a board will be hung up in the entrance to the laboratory. Copies for this purpose, printed on foolscap, can be obtained on demand.

H. K. STORKS.

---

[*Issued with Army Circulars, dated June 1873.*]

REGULATIONS to be observed in the EMPLOYMENT of LAMPS  
for LIGHTING MAGAZINES, AMMUNITION STORES, LABORATORIES,  
and their PASSAGES.

1. On no account will any but the authorised lamps be used for the purpose of lighting magazines, ammunition stores, laboratories, and their passages.

2. Such lamps only will be lighted from time to time as the officer commanding may direct.

3. A magazine copper lantern will be used for the inspection of the ammunition stores and underground passages.

4. One or more men, as may be required, will be specially detailed as "lampmen" for each work, to attend to all the lighting arrangements and stores connected therewith.

5. As all passage and wall lamps required for lighting the ammunition stores can be placed in position from the "light" passages, the lampmen will on no account pass beyond the junction of the "light" passages with the general passages.

6. When it is impossible to clean the glass of the light recess from the lamp passage, such glass must be cleaned by one of the magazine men from the inside. This in some cases may necessitate the unscrewing and removing of the frame; if so, care will be taken that it is properly replaced. This operation should be effected in the presence of the Officer or Non-commissioned Officer in charge.

7. All lamps, when not in use, will be kept in the lamp room.

8. A copy of these instructions attached to a board will be hung up in each lamp room. Copies for this purpose, printed on foolscap paper, can be obtained on demand.

9. Should any special instructions be required in any particular work for the guidance of the lampmen in the management of any peculiar lamp recesses, they should be added in manuscript.

H. K. STORKS.

---

**INSTRUCTIONS, SCRAPING, GAUGING, PAINTING, and PILING SHOT  
and SHELL (A. C. 1868, CL. 81 A. 115).**

1. Shot runs and trestles are to be supplied to all working parties employed in cleaning shot and shell. The shot or shell is to be placed on the run, and scraped with the swords until quite free from all paint and rust.

2. The plugs or corks of the shells are to be removed, and the interiors examined; those of spherical shells are to be scraped with a copper scraper, and freed from rust; as the interiors of rifled shell are lacquered, they are not to be scraped, but simply inverted to ensure their being free from water.

3. The collars should be examined, and, if necessary, removed and replaced by new ones.

4. The rivet holes should be examined, and, if necessary, cleaned out and re-waxed.

5. The threads of the screw plug are to be smeared with a solution of bees-wax and rangoon oil, and the plug screwed home into the metal bouche.

6. Previous to painting, the shot and shell are to be gauged with a high gauge, by the non-commissioned officer in charge of the party, who is to put aside all that do not gauge properly, and report the circumstance to his Commanding Officer.

7. The shot or shell are to be painted on the runs with two coats of paint; the second coat is not to be given until the first coat has thoroughly set. Tarpaulins are to be supplied for placing over the projectiles after they have received the first coat.

8. The paint is to be applied over the whole of the exterior iron surface, including the portion inside the fuze-hole as far as the metal bouche, the metal plug being for the time removed; in the case of lead-coated projectiles the painting should extend at least half an inch over the lead at either end of the projectile.

9. The bases for all piles should be firm and level, and formed of stone, concrete, or other hard material. Unserviceable shot or shell may be used for spherical iron projectiles. Shot and shell should never be piled on sand, mud, or loose shingle, even when garlands are used. Spherical shell are to be piled with their fuze holes downwards. Projectiles for rifled ordnance should be piled on their sides, especial care being taken not to injure the lead-coating or the studs.

It is important to remember that mixed paint deteriorates by keeping; if kept too long it dries up, and becomes useless. Cl. 173 A. C. 1872 states, "The paint and composition will be supplied from Woolwich on demand, prepared ready for use." In order, however, to ensure as far as possible that these articles may always be in good condition, they must not be demanded in larger quantities than will suffice for the requirements of each district for 12 months.

---

The chief constituents of the most important paints are spirits of turpentine, boiled oil, and some metallic body which is not liable to be oxidised or altered when exposed to the air.

Spirits of turpentine possess the property of dissolving fatty and resinous substances. On exposure to the air it absorbs oxygen and hardens; this quality renders it suitable as an ingredient for paints.

Linseed oil takes up oxygen on exposure to air, and hardens; from this quality it is known as a drying oil. Its drying powers are much

increased by boiling along with litharge, red lead, or binoxide of manganese ; after this process it is known as boiled oil.

From the above properties, it will be seen that paint when mixed will soon become unserviceable when exposed to the air. It is not desirable to mix paints long before they are wanting for use, even in closed tins it is apt to spoil.

An oxide of iron is the metallic body employed in the paint for projectiles ; it is termed "Pulford's magnetic paint" (called "magnetic" from the property of being attracted by a magnet). Pulford's paint is obtained by contract.

Oxides of metal are suitable for the body of paint, as they are cheap, easily obtained in a state of fine division, and not subject to oxidation on exposure to the air. Other metallic bodies, such as white lead, red lead, &c., are largely used for paints, but are more expensive.\*

#### EXTRACTS FROM REPORTS ON AMMUNITION used in the EXPEDITION to COOMASSIE.

From the report of Major Rait, C.B., it appears that the common shell and case were very good, the latter appeared to break up in all instances, and were most effective. The time and percussion fuzes acted well, but the latter were little used, as, firing through the bush, the shell would be prematurely exploded. The friction tubes acted well, and the cylinders in which the fuzes and tubes were enclosed protected them from deterioration.

The star shell were not used on service ; some fired experimentally did not appear to act well.

Major Rait recommends a quarter metal lined case suitable for mule transport for the cartridges, as they suffered from climate in the leather cases.

The rockets last received from England were in very good condition, but the composition is subject to rapid deterioration if exposed to the climatic effects of the west coast.

Although their precision could not be compared to guns, yet owing to their portability and moral effect, Major Rait would not be inclined to advocate their disuse.

They were liable to defect greatly in the bush, and might be occasionally dangerous to those using them.

Both Major Rait and Lieut. Knox recommended alterations in the rocket trough, the former stating that the elevating bar is too weak, and if bent by rough usage there is a difficulty in sliding the elevating socket up or down ; the latter states that the trough should be higher, as the rockets dip and may have their direction altered by uneven ground.

Lieut. Knox observed that the rockets burst explosively on striking a solid object such as a tree.

Lieut. Allen, R.M.A., reports favourably of the rockets and recommends that they should be made explosive.

Some rockets which were taken out of store at Elmina and appeared useless, judging by the exterior, were well up to range and did not explode in flight.

The rockets employed were 9-pr. Hale's rockets, and were packed in metal lined cases, from which, however, they were removed in transport.

\* Much information on the subject of paints will be found in a lecture by Mr. Dent, Chemical Department, R.L., contained in Lectures on Building Materials, Chatham, 1871.

TABLE OF COMBUSTIBLE COMPOSITIONS FOR LABORATORY STORES.

<b>Carcass Composition :—</b> lb. oz. Saltpetre, ground - - - 6 4 Sulphur, ground - - - 2 8 Rosin, pounded - - - 1 14 Antimony, Sulphide of - - 0 10 Tallow, Russian - - - 0 10 Turpentine, Venice - - - 0 10	<b>Miners' Portfire :—</b> lb. oz. Saltpetre, ground - - - 4 0 Sulphur, sublimed - - - 2 0 Powder, mealed, cylinder - 2 0	<b>Parachute Light Ball :—</b> lb. oz. Saltpetre, ground - - - 7 0 Sulphur, sublimed - - - 1 2 Orpiment, red - - - 0 11	<b>FUZE COMPOSITION.</b> All Wood Fuzes except 5 seconds :— lb. oz. Saltpetre, ground - - - 3 4 Sulphur, sublimed - - - 1 0 Powder, mealed, pit - - - 3 12
<b>Smoke Ball :—</b> lb. oz. Powder, L.G., bruised - - 5 0 Saltpetre, ground - - - 1 0 Coal, Sea, pounded - - - 1 8 Pitch, Swedish - - - 2 0 Tallow, Russian - - - 0 8	<b>Slow-burning Composition for Life-buoy Portfire :—</b> lb. oz. Saltpetre, ground - - - 8 0 Sulphur, ground - - - 4 0 Powder, mealed, cylinder - 1 0	<b>Stars, 7-pr. Star Shell :—</b> lb. oz. Nitrate of Baryta - - - 6 12 Chlorate of Potash - - - 4 8 Magnesium Powder - - - 6 0 Boiled Oil, 3 per cent.	<b>5 Seconds Fuzes :</b> lb. oz. Saltpetre, ground† - - - 0 1 Powder, mealed, pit - - - 1 0
<b>PORTFIRES.</b> <b>Common Portfire :—</b> lb. oz. Saltpetre, ground - - - 6 0 Sulphur, sublimed - - - 2 0 Powder, mealed, cylinder - 1 4	<b>Quick-burning Composition for Life-buoy Portfire :—</b> lb. oz. Saltpetre, ground - - - 3 0 Sulphur, sublimed - - - 2 0 Powder, mealed, pit - - - 1 0	<b>Long and Coast Guard Lights, and Lights for Wrecks :—</b> lb. oz. Saltpetre, ground - - - 7 0 Sulphur, sublimed - - - 1 12 Orpiment, red* - - - 0 8	<b>ROCKETS.</b> <b>Hale Rocket :—</b> 24-PR. 9-PR. Parts. Parts. Saltpetre, ground - - - 70 8-75 Sulphur, sublimed - - - 16 2 0 Charcoal, Alder, } Ground - - - 23 2 5
<b>Blue, or Slow Portfire :—</b> lb. oz. Water, distilled, from one to two quarts, according to the nature of the paper. Saltpetre, ground - - - 0 3	<b>LIGHTS.</b> <b>Ground Light Ball :—</b> lb. oz. dr. Saltpetre, ground - - - 6 4 0 Sulphur, ground - - - 2 8 0 Rosin, pounded - - - 1 14 0 Oil, Linseed, boiled - - - 0 7 8	<b>Signal Light, Magnesium :—</b> ozs. Saltpetre, ground - - - 14 Sulphur, sublimed - - - 34 Orpiment, red - - - 1 Magnesium, containing 25 per cent. of Paraffin - - - 04	<b>Signal Rocket Composition :—</b> lb. oz. Saltpetre, ground - - - 8 0 Sulphur, sublimed - - - 2 0 Charcoal, Dogwood - - - 3 0

\* 1 oz. more Orpiment is added for Lights for Wrecks.

† Saltpetre only necessary at times.

TABLE OF COMBUSTIBLE COMPOSITIONS FOR LABORATORY STORES—continued.

Composition for Stars of Signal Rocket:—	COLOURED FIRES.	Composition for Percussion Caps, E Time, R.L. Screw and B.L. plain Percussion Fuzes:—	Detonating Composition for Friction Tube:—
<p>lb. oz.</p> <p>Saltpetre, ground - - - 8 0</p> <p>Sulphur, sublimed - - - 2 0</p> <p>Antimony, Sulphide of - - - 2 0</p> <p>Isinglass - - - 0 3½</p> <p>Spirits, methylated - - - pint 1</p> <p>Vinegar, L.G. mealcd, - - - quart 1</p> <p>for priming - - - } lb. 1 oz. 0</p>	<p>lb. oz. dr.</p> <p>Blue { Chlorate of Potash and copper - - - 4 8 0</p> <p>          { Chlorine - - - 2 10 0</p> <p>          { Shellac, pale - - - 1 5 0</p> <p>          { Chlorate of Potash - - - 4 15 0</p> <p>Red { Nitrate of Strontia - - - 2 8 0</p> <p>      { Calomel - - - 1 9 8</p> <p>      { Dextrine - - - 0 11 0</p> <p>      { Shellac, pale - - - 0 9 0</p> <p>      { Sulphide of copper - - - 0 2 0</p> <p>      { Chlorate of Potash - - - 2 7 6</p> <p>Green { Nitrate of Baryta - - - 5 0 0</p> <p>      { Calomel - - - 1 0 0</p> <p>      { Shellac, pale - - - 0 2 0</p> <p>      { Charcoal (120 mesh) - - - 0 3 0</p> <p>      { Sulphur, sublimed - - - 1 8 0</p> <p>      { Chlorate of Potash - - - 2 0 0</p>	<p>lb. oz.</p> <p>Mercury, Fulminate of - - - 0 6</p> <p>Potash, Chlorate of - - - 0 6</p> <p>Antimony, Sulphide of - - - 0 4</p>	<p>lb. oz.</p> <p>Potash, Chlorate of - - - 0 0</p> <p>Antimony, Sulphide of - - - 0 0</p> <p>Sulphur, sublimed - - - 0 0½</p> <p>Powder, mealcd - - - 0 1</p> <p>Damped with spirits, methylated, 1 quart, shellac 48 grains, in the proportion of 200 minims to 1,000 grains of composition.</p>
<p>MATCH.</p> <p>Slow Match:—</p> <p>Hemp, Yarn, pure, Russian lb. 100</p> <p>Ashes, Wood - - - bushel 1</p> <p>Water - - - - - gals. 50</p>	<p>DETONATING COMPOSITIONS.</p> <p>FUZES.</p> <p>Detonating Composition for Boxer 5, 9, and 20 seconds Fine-Fuze, B.L.:—</p> <p>Parts.</p> <p>Potash, Chlorate of - - - 6</p> <p>Antimony, Sulphide of - - - 4</p> <p>Mercury, Fulminate of - - - 4</p> <p>Damped with varnish, of spirits, methylated, 1 pint, shellac 646 grains, in the proportion of 24 minims to 100 grains of composition.</p>	<p>Detonating Composition for Pettman Percussion Fuzes:—</p> <p>Parts.</p> <p>Potash, Chlorate of - - - 12</p> <p>Antimony, Sulphide of - - - 12</p> <p>Sulphur, sublimed - - - 1</p> <p>Powder, mealcd, L.G. - - - 1</p> <p>Damped with varnish, of spirits, methylated, 1 pint, shellac 113 grains, in the proportion of 40 minims to 100 grains of composition.</p>	<p>Tube Life Saving Rocket:—</p> <p>Potash, Chlorate of, 6 oz.</p> <p>Antimony, Sulphide of, 6 oz.</p> <p>Ground Glass, 1 oz. 10 dra.</p> <p>Damped with varnish, of spirits, methylated, 1 quart, shellac 357 grains, in the proportion of 75 minims to 1,000 grains of composition.</p>
<p>Quick Match:—</p> <p>4 threads, threads, threads.</p> <p>lb. oz. lb. oz. lb. oz.</p> <p>Cotton Wick 1 10 2 3 2 7</p> <p>Gum, Arabic 0 8 0 9 0 10</p> <p>Powder, } 20 0 20 0 24 0</p> <p>mecalcd, } cylinder, }</p> <p>Water, distilled 8 pts. 9 pts. 10 pts.</p>	<p>DETONATING COMPOSITIONS.</p> <p>FUZES.</p> <p>Detonating Composition for Boxer 5, 9, and 20 seconds Fine-Fuze, B.L.:—</p> <p>Parts.</p> <p>Potash, Chlorate of - - - 6</p> <p>Antimony, Sulphide of - - - 4</p> <p>Mercury, Fulminate of - - - 4</p> <p>Damped with varnish, of spirits, methylated, 1 pint, shellac 646 grains, in the proportion of 24 minims to 100 grains of composition.</p>	<p>Detonating Composition for Copper Tubes.</p> <p>Friction Tube:—</p> <p>lb. oz.</p> <p>Potash, Chlorate of - - - 0 6</p> <p>Antimony, Sulphide of - - - 0 6</p> <p>Sulphur, sublimed - - - 0 0½</p> <p>Damped with spirits, methylated, 1 quart, shellac 324 grains, in the proportion of 200 minims to 1,000 grains of composition.</p>	<p>Detonating Composition for Friction Tube:—</p> <p>lb. oz.</p> <p>Potash, Chlorate of - - - 0 0</p> <p>Antimony, Sulphide of - - - 0 0</p> <p>Sulphur, sublimed - - - 0 0½</p> <p>Powder, mealcd - - - 0 1</p> <p>Damped with spirits, methylated, 1 quart, shellac 48 grains, in the proportion of 200 minims to 1,000 grains of composition.</p>

For the Detonating Compositions used with Electric Tubes and Detonators, see p. 74.

TABLE OF PAINTS AND OTHER NON-COMBUSTIBLE COMPOSITIONS FOR LABORATORY STORES.

<p>1.—Pulford's Magnetic Black Paint for all Shot and Shell:—</p> <table border="0"> <tr><td>Pulford's</td><td>lb. oz.</td></tr> <tr><td>Litharge</td><td>112 0</td></tr> <tr><td>Oil, boiled</td><td>10 0</td></tr> <tr><td>Turpentine, Spirits</td><td>qrts. 20</td></tr> <tr><td></td><td>" 12</td></tr> </table>	Pulford's	lb. oz.	Litharge	112 0	Oil, boiled	10 0	Turpentine, Spirits	qrts. 20		" 12	<p>6.—Stone Colour for Brass Powder Cases and Zinc Cylinders, § 287:—</p> <table border="0"> <tr><td>Lead, white</td><td>lb. oz.</td></tr> <tr><td>Coppers</td><td>28 0</td></tr> <tr><td>Umber</td><td>0 12</td></tr> <tr><td>Varnish, Copal</td><td>0 8</td></tr> <tr><td>Gold Size</td><td>qrts. 3</td></tr> <tr><td>Turpentine, Spirits</td><td>" 2</td></tr> <tr><td></td><td>" 2</td></tr> </table>	Lead, white	lb. oz.	Coppers	28 0	Umber	0 12	Varnish, Copal	0 8	Gold Size	qrts. 3	Turpentine, Spirits	" 2		" 2	<p>11.—Paste:—</p> <table border="0"> <tr><td>Flour</td><td>lb. oz.</td></tr> <tr><td>Alum, pounded</td><td>2 0</td></tr> <tr><td>Water</td><td>0 1</td></tr> <tr><td></td><td>gal. 1</td></tr> </table>	Flour	lb. oz.	Alum, pounded	2 0	Water	0 1		gal. 1	<p>15.—Black for Life-buoy Portfire and Body of Wood Fuze:—</p> <table border="0"> <tr><td>Black, Lamp</td><td>lb. oz.</td></tr> <tr><td>Shellac, Gum</td><td>2 0</td></tr> <tr><td>Spirits, methylated</td><td>10 0</td></tr> <tr><td></td><td>gals. 3</td></tr> </table>	Black, Lamp	lb. oz.	Shellac, Gum	2 0	Spirits, methylated	10 0		gals. 3		
Pulford's	lb. oz.																																												
Litharge	112 0																																												
Oil, boiled	10 0																																												
Turpentine, Spirits	qrts. 20																																												
	" 12																																												
Lead, white	lb. oz.																																												
Coppers	28 0																																												
Umber	0 12																																												
Varnish, Copal	0 8																																												
Gold Size	qrts. 3																																												
Turpentine, Spirits	" 2																																												
	" 2																																												
Flour	lb. oz.																																												
Alum, pounded	2 0																																												
Water	0 1																																												
	gal. 1																																												
Black, Lamp	lb. oz.																																												
Shellac, Gum	2 0																																												
Spirits, methylated	10 0																																												
	gals. 3																																												
<p>2.—Slate Colour Paint for Ground Light Ball:—</p> <table border="0"> <tr><td>Lead, white, ground</td><td>lb. oz.</td></tr> <tr><td>Black, Lamp</td><td>23 0</td></tr> <tr><td>Litharge</td><td>2 0</td></tr> <tr><td>Oil, Linsced, boiled</td><td>0 12</td></tr> <tr><td>Turpentine, Spirits</td><td>qrts. 2</td></tr> <tr><td></td><td>" 1</td></tr> </table>	Lead, white, ground	lb. oz.	Black, Lamp	23 0	Litharge	2 0	Oil, Linsced, boiled	0 12	Turpentine, Spirits	qrts. 2		" 1	<p>7.—Black for B.L. plain Percussion Fuze, Bodies of Quill, and Copper Friction Tubes:—</p> <table border="0"> <tr><td>Black, Vegetable</td><td>lb. oz.</td></tr> <tr><td>Litharge</td><td>0 8</td></tr> <tr><td>Varnish, Copal</td><td>0 8</td></tr> <tr><td>Turpentine, Spirits</td><td>qrts. 3</td></tr> <tr><td>Gold Size</td><td>" 2</td></tr> <tr><td></td><td>" 1½</td></tr> </table>	Black, Vegetable	lb. oz.	Litharge	0 8	Varnish, Copal	0 8	Turpentine, Spirits	qrts. 3	Gold Size	" 2		" 1½	<p>12.—Flesh Colour for Common Portfire, &amp;c.:—</p> <table border="0"> <tr><td>Lead, white, ground</td><td>lb. oz.</td></tr> <tr><td>Lead, red, dry</td><td>20 0</td></tr> <tr><td>Shellac, Gum</td><td>0 4</td></tr> <tr><td>Spirits, methylated</td><td>10 0</td></tr> <tr><td></td><td>gals. 3</td></tr> </table>	Lead, white, ground	lb. oz.	Lead, red, dry	20 0	Shellac, Gum	0 4	Spirits, methylated	10 0		gals. 3	<p>16.—Thick Black Paint for Ring round Cap of Wood Fuze:—</p> <table border="0"> <tr><td>Shellac, Gum</td><td>lb. oz.</td></tr> <tr><td>Black, Lamp</td><td>1 0</td></tr> <tr><td>Spirits, methylated</td><td>0 8</td></tr> <tr><td></td><td>pints 1½</td></tr> </table>	Shellac, Gum	lb. oz.	Black, Lamp	1 0	Spirits, methylated	0 8		pints 1½
Lead, white, ground	lb. oz.																																												
Black, Lamp	23 0																																												
Litharge	2 0																																												
Oil, Linsced, boiled	0 12																																												
Turpentine, Spirits	qrts. 2																																												
	" 1																																												
Black, Vegetable	lb. oz.																																												
Litharge	0 8																																												
Varnish, Copal	0 8																																												
Turpentine, Spirits	qrts. 3																																												
Gold Size	" 2																																												
	" 1½																																												
Lead, white, ground	lb. oz.																																												
Lead, red, dry	20 0																																												
Shellac, Gum	0 4																																												
Spirits, methylated	10 0																																												
	gals. 3																																												
Shellac, Gum	lb. oz.																																												
Black, Lamp	1 0																																												
Spirits, methylated	0 8																																												
	pints 1½																																												
<p>3.—Yellow Paint for Smoke Ball:—</p> <table border="0"> <tr><td>Lead, white, ground</td><td>lb. oz.</td></tr> <tr><td>Lead, Sugar of</td><td>5 0</td></tr> <tr><td>Chrome Yellow</td><td>0 4</td></tr> <tr><td>Turpentine, Spirits</td><td>0 0½</td></tr> <tr><td>Oil, Linsced, raw</td><td>pint 1</td></tr> <tr><td></td><td>" 0½</td></tr> </table>	Lead, white, ground	lb. oz.	Lead, Sugar of	5 0	Chrome Yellow	0 4	Turpentine, Spirits	0 0½	Oil, Linsced, raw	pint 1		" 0½	<p>8.—Thick Brown Varnish:—</p> <table border="0"> <tr><td>Shellac, Gum</td><td>lb. oz.</td></tr> <tr><td>Spirits, methylated</td><td>16 0</td></tr> <tr><td></td><td>gals. 2</td></tr> </table>	Shellac, Gum	lb. oz.	Spirits, methylated	16 0		gals. 2	<p>13.—Black for Plates of Life-buoy Portfire:—</p> <table border="0"> <tr><td>Black, Lamp</td><td>lb. oz.</td></tr> <tr><td>Litharge</td><td>1 0</td></tr> <tr><td>Oil, Linsced, boiled</td><td>0 2</td></tr> <tr><td>Turpentine, Spirits</td><td>qrt. 1</td></tr> <tr><td></td><td>pint 1</td></tr> </table>	Black, Lamp	lb. oz.	Litharge	1 0	Oil, Linsced, boiled	0 2	Turpentine, Spirits	qrt. 1		pint 1	<p>17.—List of Ingredients used for the Paint of M.L. and B.L. Wood Time Fuzes:—</p> <table border="0"> <tr><td>Body of Fuze</td><td>lbs.</td></tr> <tr><td>Lead, white</td><td>10</td></tr> <tr><td>Shellac</td><td>5</td></tr> <tr><td>Spirits, methylated</td><td>gal. 1½</td></tr> </table>	Body of Fuze	lbs.	Lead, white	10	Shellac	5	Spirits, methylated	gal. 1½						
Lead, white, ground	lb. oz.																																												
Lead, Sugar of	5 0																																												
Chrome Yellow	0 4																																												
Turpentine, Spirits	0 0½																																												
Oil, Linsced, raw	pint 1																																												
	" 0½																																												
Shellac, Gum	lb. oz.																																												
Spirits, methylated	16 0																																												
	gals. 2																																												
Black, Lamp	lb. oz.																																												
Litharge	1 0																																												
Oil, Linsced, boiled	0 2																																												
Turpentine, Spirits	qrt. 1																																												
	pint 1																																												
Body of Fuze	lbs.																																												
Lead, white	10																																												
Shellac	5																																												
Spirits, methylated	gal. 1½																																												
<p>4.—Luting:—</p> <table border="0"> <tr><td>Tallow</td><td>parts 6</td></tr> <tr><td>Beeswax</td><td>" 6</td></tr> </table>	Tallow	parts 6	Beeswax	" 6	<p>9.—Thin Brown Varnish:—</p> <table border="0"> <tr><td>Shellac, Gum</td><td>lb. oz.</td></tr> <tr><td>Spirits, methylated</td><td>8 0</td></tr> <tr><td></td><td>gals. 2</td></tr> </table>	Shellac, Gum	lb. oz.	Spirits, methylated	8 0		gals. 2	<p>14.—Drab Colour for Long, Signal, and Coast Guard Lights, and 1 lb. Signal Coloured Rocketts:—</p> <table border="0"> <tr><td>Lead, white, ground</td><td>lb. oz.</td></tr> <tr><td>Shellac, Gum</td><td>20 0</td></tr> <tr><td>Spirits, methylated</td><td>10 0</td></tr> <tr><td></td><td>gals. 3</td></tr> </table>	Lead, white, ground	lb. oz.	Shellac, Gum	20 0	Spirits, methylated	10 0		gals. 3	<p>18.—Blue for Parachute Fuze:—</p> <table border="0"> <tr><td>Ultramarine</td><td>lb. oz.</td></tr> <tr><td>Lead, white, ground</td><td>0 4</td></tr> <tr><td>Shellac, Gum</td><td>3 0</td></tr> <tr><td>Spirits, methylated</td><td>1 0</td></tr> <tr><td></td><td>gal. ½</td></tr> </table>	Ultramarine	lb. oz.	Lead, white, ground	0 4	Shellac, Gum	3 0	Spirits, methylated	1 0		gal. ½														
Tallow	parts 6																																												
Beeswax	" 6																																												
Shellac, Gum	lb. oz.																																												
Spirits, methylated	8 0																																												
	gals. 2																																												
Lead, white, ground	lb. oz.																																												
Shellac, Gum	20 0																																												
Spirits, methylated	10 0																																												
	gals. 3																																												
Ultramarine	lb. oz.																																												
Lead, white, ground	0 4																																												
Shellac, Gum	3 0																																												
Spirits, methylated	1 0																																												
	gal. ½																																												
<p>5.—Kit Composition:—</p> <table border="0"> <tr><td>Pitch, Swedish</td><td>lb. oz.</td></tr> <tr><td>Tallow, Russian</td><td>6 1½</td></tr> <tr><td>Beeswax</td><td>1 1½</td></tr> <tr><td>Rosin</td><td>6 1½</td></tr> <tr><td></td><td>7 8</td></tr> </table>	Pitch, Swedish	lb. oz.	Tallow, Russian	6 1½	Beeswax	1 1½	Rosin	6 1½		7 8	<p>10.—Shellac Putty:—</p> <table border="0"> <tr><td>Whiting</td><td>lb. oz.</td></tr> <tr><td>Shellac, Gum</td><td>6 0</td></tr> <tr><td>Spirits, methylated</td><td>2 0</td></tr> <tr><td></td><td>qrt. 1</td></tr> </table>	Whiting	lb. oz.	Shellac, Gum	6 0	Spirits, methylated	2 0		qrt. 1	<p>Distilling</p> <table border="0"> <tr><td>For figures</td><td>Oil, raw</td><td>pints 1</td></tr> <tr><td></td><td>Turpentine</td><td>gills ½</td></tr> <tr><td>For body</td><td>Vermillion</td><td>3</td></tr> <tr><td></td><td>Shellac</td><td>4</td></tr> <tr><td></td><td>Spirits, methylated</td><td>gal. 1</td></tr> <tr><td>For M. L. and B. L.</td><td>Blue Ultramarine</td><td>ozs. 4</td></tr> <tr><td></td><td></td><td></td></tr> </table>	For figures	Oil, raw	pints 1		Turpentine	gills ½	For body	Vermillion	3		Shellac	4		Spirits, methylated	gal. 1	For M. L. and B. L.	Blue Ultramarine	ozs. 4							
Pitch, Swedish	lb. oz.																																												
Tallow, Russian	6 1½																																												
Beeswax	1 1½																																												
Rosin	6 1½																																												
	7 8																																												
Whiting	lb. oz.																																												
Shellac, Gum	6 0																																												
Spirits, methylated	2 0																																												
	qrt. 1																																												
For figures	Oil, raw	pints 1																																											
	Turpentine	gills ½																																											
For body	Vermillion	3																																											
	Shellac	4																																											
	Spirits, methylated	gal. 1																																											
For M. L. and B. L.	Blue Ultramarine	ozs. 4																																											



Table of Paints and other Non-combustible Compositions for Laboratory Stores—continued.

19.—Varnish for the Gut and Silk over Detonating Ball of Pettman Fuze:— lb. oz. Shellac, Gum . . . . . 0 84 Spirits, methylated . . . . . qrt. 1	25.—Waterproof Varnish for Percussion Caps:— lb. oz. Shellac, Gum . . . . . 2 2 Spirits, methylated . . . . . gal. 1	29.—No. 1 Fuze, Electric, and Body of No. 4 Tube, Electric:— Varnish, Copal . . . . . qrts. 3 Gold Size . . . . . pinks 14 Turps . . . . . qrts. 2 Litharge . . . . . oz. 8 Vegetable Black . . . . . " 8	33.—No. 5 Detonator, Electric, No. 8 Detonator Bickford Fuze, also Tube of Nos. 6 and 7 Detonators, Electric, and Platinum Wire:— Varnish, Copal . . . . . qrts. 3 Turpentine, Spirits . . . . . " 1 Gold Size . . . . . lbs. 2½ Vermillion . . . . . " 2½ Litharge . . . . . oz. 5
20.—Lacquer for Brass Fuzes and other Brass Work:— lb. oz. Seedlac . . . . . 5 0 Turmeric . . . . . 2 8 Spirits, methylated . . . . . gals. 5	*26.—Red for Outside of Case of Hale's War, and Boxer Life-Saving Rockets, § 2441:— lb. oz. Lead { Red . . . . . 3 0 White . . . . . 1 0 Litharge . . . . . 0 4 Copernus . . . . . 0 2 Oil, Linseed, boiled . . . . . pint 1	30.—Head of No. 2 Fuze, Submarine, and Head of No. 4 Tube, Electric:— Brown { Shellac . . . . . lbs. 4 Spirits, methylated gals. 1 Black { Shellac . . . . . lbs. 5 Spirits, methylated, coloured with Vegetable Black gal. 1	34.—Body of No. 6 Detonator, Electric, Submarine:— Varnish, Copal . . . . . " gill 4 Gold Size . . . . . " " 4 Turpentine, Spirits . . . . . " " 4 Litharge . . . . . " oz. 4 Lead, white, dry . . . . . " 4 Ultramarine . . . . . " drs. 5
21.—Fuze Grease:— lb. oz. Tallow, Russian . . . . . 3 0 Beeswax . . . . . 3 4 Oil, Sweet . . . . . qrts. 2	27.—Anti-corrosive for Inside of Hale's War, and Boxer Life-Saving Rocket Cases, § 1940:— Copal Varnish . . . . . pints 4 Gold Size . . . . . " 1 Turpentine, Spirits . . . . . " 14 Lead, white, dry . . . . . lbs. 7	31.—Body of No. 2 Fuze, Submarine:— Seedlac . . . . . lbs. 5 Turmeric . . . . . " 24 Spirits, methylated . . . . . gals. 5	35.—Cement, securing, Pettman G.S. Fuze against damp:— lb. oz. Shellac . . . . . " 7 8 Spirits, methylated . . . . . gal. 1 Tar, Stockholm . . . . . " 4 To the above add equal parts, by weight, of Venetian Red.
22.—Black Paint for Iron Buster:— lb. oz. Black, Lamp . . . . . 3 0 Litharge . . . . . 1 0 Oil, Linseed, boiled . . . . . pints 3 Turpentine, Spirits . . . . . " 3 The second coat is Brunswick Black.	28.—White for Case of Signal Rocket:— lb. oz. Lead, white, ground . . . . . 12 0 Blue, Prussian . . . . . 0 04 Lead, Sugar of . . . . . 0 12 Oil, Linseed, boiled . . . . . qrts. 2 Turpentine, Spirits . . . . . " 1	32.—No. 3 Fuze, and No. 7 Detonator, Electric Platinum Wire:— Lead, white, ground, wet . . . . . drs. 144 Litharge . . . . . " 14 Ultramarine . . . . . gr. 1 Copal . . . . . oz. 4 Gold Size . . . . . " 4 Turpentine . . . . . " 4	36.—Cement for securing Tin Tubes to Heads of No. 2 Fuze, and 5, 6, 7, and 8 Detonators:— lb. oz. Pitch, Swedish . . . . . 1 0 Gutta Percha . . . . . 1 0 Resin . . . . . 0 8 Wax, Bees, No. 1. . . . . 0 8 Venetian Red . . . . . 0 8
23.—Lacquer for Inside of 100-pr. S.B. Shell and Shells for Rifled Guns:— lb. oz. Rosin . . . . . 12 0 Brown, Spanish . . . . . 2 0 Plaster of Paris . . . . . 1 0 Turpentine, Spirits . . . . . pint 4	24.—Lubricant for Boxer Lubricating Wad, for Armstrong B.L. Gun:— lb. oz. Tallow, Russian . . . . . 6 0 Oil, Linseed, raw . . . . . 6 0		

\* This paint is also used for the heads of F.S. Shrapnel Shells.

## RING GAUGES FOR PROJECTILES\* § 1314.

## SMOOTH BORE.

CALIBRE OF 13-INCH MORTAR, 13·0 INCHES.				CALIBRE OF 24-PR. GUN, 5·823 ; HOWITZER, 5·72 ; 5½-INCH HOWITZER, 5·68 ; 5½-INCH MORTAR, 5·62 INCHES.					
H.G. 13-inch	-	-	-	12·88	H.G. 24-pr.	-	-	-	5·639†
L.G. 13-inch	-	-	-	12·8	L.G. 24-pr.	-	-	-	5·57
CALIBRE OF 10-INCH GUN, HOWITZER, AND MORTAR, 10·0 INCHES.				CALIBRE OF 18-PR. GUN, 5·292 AND 5·17 INCHES.					
H.G. 10-inch	-	-	-	9·88	H.G. 18-pr.	-	-	-	5·124
L.G. 10-inch	-	-	-	9·82	L.G. 18-pr.	-	-	-	5·074
CALIBRE OF 100-PR. GUN, 9·0 INCHES.				CALIBRE OF 12-PR. GUN, 4·623 ; 12-PR. HOWITZER, 4·58 ; 4½-INCH OR COEHORN HOWITZER AND MORTAR, 4·52 INCHES.					
H.G. 100-pr.	-	-	-	8·92	H.G. 12-pr.	-	-	-	4·54
L.G. 100-pr.	-	-	-	8·88	L.G. 12-pr.	-	-	-	4·432
CALIBRE OF 68-PR. GUN, 8·12 INCHES ; 8-INCH GUN, 8·05 INCHES ; 8-INCH HOWITZER AND MORTAR, 8·0 INCHES.				CALIBRE OF 9-PR. GUN, 4·2 INCHES.					
H.G. 68-pr.	-	-	-	7·95	H.G. 9-pr.	-	-	-	4·117
L.G. 68-pr.	-	-	-	7·82	L.G. 9-pr.	-	-	-	4·06
CALIBRE OF 56-PR. GUN, 7·65 INCHES.				CALIBRE OF 6-PR. GUN, 3·668 INCHES.					
H.G. 56-pr.	-	-	-	7·51	H.G. 6-pr.	-	-	-	3·585
L.G. 56-pr.	-	-	-	7·45	L.G. 6-pr.	-	-	-	3·532
CALIBRE OF 42-PR. GUN, 6·97 INCHES.				SEA SERVICE HAND GRENADE.					
H.G. 42-pr.	-	-	-	6·795	H.G. hand grenade, S.S.	-	-	-	3·496
L.G. 42-pr.	-	-	-	6·735	L.G. hand grenade, S.S.	-	-	-	3·456
CALIBRE OF 32-PR. GUN, 6·41, 6·375, 6·35, AND 6·3 INCHES ; 32-PR. HOWITZER, 6·3 INCHES.				LAND SERVICE HAND GRENADE.					
H.G. 32-pr.	-	-	-	6·207	H.G. hand grenade, L.S.	-	-	-	2·778
L.G. 32-pr.	-	-	-	6·147	L.G. hand grenade, L.S.	-	-	-	2·738

\* "The issue of low gauges is to be restricted to stations of inspection," § 1314. "It is not intended to interfere with the limits of manufacture at present allowed in spherical projectiles, but merely to simplify the regulations for their inspection at out stations." *W.O.O.* 31st Dec. 1866, being errata on Circular 11 (New Series).

† For future manufacture this gauge will be 5·64",—*W.O.* Letter, 29/9/66, 75/12/2914.

## RING GAUGES FOR SAND SHOT.

H.G. 4 lb. sand shot	-	-	-	3·1	L.G. 6½ oz. sand shot	-	-	-	1·45
L.G. 4 lb. sand shot	-	-	-	3·05	H.G. 6 oz. sand shot	-	-	-	1·4
H.G. 3 lb. sand shot	-	-	-	2·81	L.G. 6 oz. sand shot	-	-	-	1·37
L.G. 3 lb. sand shot	-	-	-	2·77	H.G. 5 oz. sand shot	-	-	-	1·34
H.G. 2 lb. sand shot	-	-	-	2·46	L.G. 5 oz. sand shot	-	-	-	1·31
L.G. 2 lb. sand shot	-	-	-	2·42	H.G. 4 oz. sand shot	-	-	-	1·23
H.G. 1½ lb. sand shot	-	-	-	2·23	L.G. 4 oz. sand shot	-	-	-	1·2
L.G. 1½ lb. sand shot	-	-	-	2·2	H.G. 3½ oz. sand shot	-	-	-	1·16
H.G. 1 lb. sand shot.	-	-	-	1·95	L.G. 3½ oz. sand shot	-	-	-	1·13
L.G. 1 lb. sand shot	-	-	-	1·92	H.G. 3 oz. sand shot	-	-	-	1·12
H.G. 13¼ oz. sand shot	-	-	-	1·83	L.G. 3 oz. sand shot	-	-	-	1·1
L.G. 13¼ oz. sand shot	-	-	-	1·8	H.G. 2 oz. sand shot	-	-	-	0·98
H.G. 8 oz. sand shot	-	-	-	1·55	L.G. 2 oz. sand shot	-	-	-	0·96
L.G. 8 oz. sand shot	-	-	-	1·52	H.G. 1½ oz. sand shot	-	-	-	0·88
H.G. 6½ oz. sand shot	-	-	-	1·48	L.G. 1½ oz. sand shot	-	-	-	0·86



Table of Filled Cannon Cartridges.—Smooth-bore—continued.

NATURE.	lb. oz.	Dis- meter of Car- ridge Body.	Dis- meter of Ring Gauge.	Length of Cartridge.		Number of Hoops.		Barrel, Whole.		Ammu- nition Box.		Whole.		Half.		Quarter.		Pentagon.		Secti- onal.		Plain.		Corrugated.		REMARKS.	
				From	To	Braid.	Worsted.	Number.	Weight.	Number.	Weight.	Number.	Weight.	Number.	Weight.	Number.	Weight.	Number.	Weight.	Number.	Weight.	Number.	Weight.	Number.	Weight.		
																											in.
32-pr.	10 0	6.0	6.00	10.75	—	—	3	9	125	4	62	11	160	4	70	—	—	—	11	172	—	—	12	192	14	192	lb. 192
	8 0	6.0	6.00	9.2	—	—	2	12	132	5	63	14	162	6	78	—	—	—	14	175	—	—	16	200	18	196	lb. 196
	7 0	6.0	6.00	8.0	—	—	2	13	126	7	72	16	162	7	78	—	—	—	16	175	—	—	18	198	21	190	lb. 190
	6 0	5.9	6.09	7.5	—	—	2	16	131	8	71	19	164	8	78	—	—	—	19	177	—	—	21	198	24	196	lb. 196
	5 0	5.8	6.09	6.5	—	—	2	19	130	10	73	22	160	10	80	—	—	—	22	173	—	—	20	202	30	202	lb. 202
	4 0	5.8	6.09	5.75	—	—	1	25	136	12	71	27	153	13	82	—	—	—	27	171	—	—	32	201	36	196	lb. 196
24-pr.	8 0	5.5	5.52	10.5	—	—	3	13	131	5	63	14	162	6	78	—	—	—	14	175	—	—	16	200	—	—	—
	6 0	5.5	5.52	8.3	—	—	2	16	131	8	71	19	164	8	78	—	—	—	10	177	—	—	21	198	—	—	—
	5 0	5.5	5.52	7.5	—	—	2	19	130	10	73	22	160	10	80	—	—	—	22	173	—	—	20	202	—	—	—
	4 0	5.4	5.52	6.5	—	—	2	25	136	13	71	27	153	13	82	—	—	—	27	171	—	—	32	201	—	—	—
	3 0	5.2	5.52	5.2	—	—	1	32	132	18	77	37	161	17	81	—	—	—	37	174	—	—	43	202	—	—	—
	6 0	5.0	5.02	9.0	—	—	3	16	131	8	71	19	164	8	78	—	—	—	19	177	—	—	21	198	25	202	lb. 202
18-pr.	3 0	4.0	5.02	5.75	—	—	1	32	132	18	77	37	161	17	81	—	—	—	37	174	—	—	43	202	53	202	lb. 202
	4 0	4.35	4.39	8.6	—	—	3	25	136	12	71	27	153	13	82	—	—	—	27	171	—	—	32	201	—	—	—
12-pr.	2 0	4.3	4.39	6.0	—	—	2	37	130	18	69	44	161	20	81	—	—	—	44	174	—	—	51	201	—	—	—
	2 0	4.3	4.39	6.0	—	—	2	37	130	18	69	44	161	20	81	—	—	—	44	174	—	—	51	201	—	—	—

Table of Filled Cannon Cartridges.—Smooth-bore—continued.

NATURE.	Charge. L.G. Powder.	Dia- meter of Car- tridge Body.	Dia- meter of Ring Gauge.	Length of Cartridge.		Number of Hoops.		Barrel Whole.		Ammu- nition Box.	Case, Powder, Copper-lined.						Case, Powder, Brass.				REMARKS.																										
				From	To	Braid.	Worst.	Number.	Weight.		Whole.		Half.		Quarter.		Pentagon.		Secti- onal.			Rectangular.																									
											Number.	Weight.	Number.	Weight.	Number.	Weight.	Number.	Weight.	Number.	Weight.		Number.	Weight.																								
				lb. oz.	in.	in.	in.	in.	lb.		lb.	lb.	lb.	lb.	lb.	lb.	lb.	lb.	lb.	lb.		lb.	lb.	lb.	lb.																						
9-pr.	3 0	3'9	4'02	8'2	—	3	32	132	77	18	37	161	17	81	6	37	174	17	94	43	202	—	—																								
																								8'7	—	2	38	132	69	44	161	20	81	8	39	174	20	94	51	201	—	—					
																																											4'9	—	1	58	124
6-pr.	1 8	3'35	3'5	5'5	—	2	58	124	69	30	74	162	35	83	12	37	175	35	96	84	199	—	—																								
																								4'4	—	1	94	134	42	110	102	50	81	20	39	110	175	50	94	125	199	—	—				
																																												12'75	—	3	4
13-inch mortar	16 0	8'2	—	12'0	—	3	5	115	70	3	6	145	—	—	—	—	—	—	—	—	—	—	—																								
																								7'3	—	1	10	125	6	67	12	158	—	—	—	—	—	—	—	—	—	—	—	—	—		
																																														9'7	—
10-inch "	9 8	6'5	—	5'5	—	1	25	136	71	12	27	158	13	82	—	—	—	—	—	—	—	—	—																								
																								5'0	—	1	48	133	24	72	55	161	25	81	10	39	175	25	94	64	202	—	—				
																																												3'1	—	1	220
8-inch "	4 0	6'0	—	5'5	—	1	260	122	160	76	300	147	160	82	70	41	300	160	150	350	184	—	—																								
																								7'0	—	1	13	126	7	72	16	162	7	78	—	—	—	—	—	—	—	—	—	—	—	—	
																																															5'3
10-inch howitzer	4 0	6'25	7'76	6'0	—	1	25	136	71	12	27	158	13	82	—	—	—	—	—	—	—	—	—																								
																								6'7	—	1	25	136	12	71	27	158	13	82	—	—	—	—	—	—	—	—	—	—	—	—	—
8-inch "	3 0	5'2	6'67	5'1	—	1	32	132	18	77	37	161	17	81	—	—	—	—	—	—	—	—	—																								
																								6'0	—	1	25	136	12	71	27	158	13	82	—	—	—	—	—	—	—	—	—	—	—	—	—





CHARGES for S.B. GUNS and MORTARS, omitting such charges as may be looked on as practically obsolete. The charges for Carronades, Howitzers, and the 5½ and 4½ inch Mortars will be found in the Tables of Filled Cannon Cartridges. §§ 728, 1780.

Nature of Gun.	Charge	Purpose for which each Charge is used.	Remarks.
10-inch - -	lbs. 12	Service.	
" - -	8	Saluting.	
8-inch - -	10	Service, 65 and 60 cwt. guns.	
" - -	8	Service, 52 or 50 cwt. guns.	
" - -	6	Saluting.	
68-pr. - -	16	Service, 95 cwt. gun -	The 112 cwt. and 87 cwt. guns are nearly obsolete.
" " - -	8	Saluting - - -	A number of naval charges are omitted.
56 " - -	14	Service - - -	The 56-pr. is nearly obsolete.
" " - -	6	Saluting.	
42 " - -	10½	Service, 67 cwt. gun.	
" " - -	6	Saluting.	
32 " - -	10	Service, 63 to 56 cwt. guns.	
" " - -	8	Service, 50 to 48 cwt. guns.	
" " - -	7	Service, 45 cwt. gun.	
" " - -	6	Service, 46, 42, 41, 40, and 39 cwt. guns.	
" " - -	5	Service, 32 cwt. gun and saluting.	
24 " - -	8	Service, 50 and 48 cwt. guns.	
" " - -	3	Saluting.	
18 " - -	6	42 to 38 cwt. guns.	
" " - -	3	Saluting.	
12 " - -	4	Service, iron and bronze guns.	
" " - -	2	Saluting.	
9 " - -	2½	Service, bronze guns.	
" " - -	1½	Saluting.	
6 " - -	1½	Service, bronze guns.	
" " - -	1	Saluting.	
S.S. 13-inch mortar -	20	Highest charge.	
" " - -	16	Carcass.	
L.S. 13-inch mortar -	9	Highest charge.	
S.S. 10-inch - -	9½	" "	
L.S. 10-inch - -	4	" "	
L.S. 8-inch - -	2	" "	

TABLES showing QUANTITIES of BRAID, SILK, THREAD, and WORSTED required to make up 100 of each of the under-mentioned CARTRIDGES.

Muzzle-loading.

Description.	Making, Empty.				Filling and Completing.			
	Braid, Worsted, Blue, Broad.	Braid, Worsted, Blue, Narrow.	Worsted, White, No. 20.	Silk, Sewing.	Worsted, White, No. 14.	Silk, Twist.		
	yards.	yards.	oz.	oz.	oz.	oz.		
12-inch (35 ton) 110 lb. P.	-	-	2300	9	5	-		
12-inch (35 or 25 ton) 85 ,, P. or 67 lb. R.L.G.	-	-	1650	7	5	-		
12-inch (25 ton) 55 ,, P. or 50 lb. R.L.G.	-	-	1050	6	5	-		
11-inch	-	-	85 ,, P. or 70 lb. R.L.G.	-	1800	7	4	
			60 ,, P. or 50 lb. R.L.G.	-	1400	6	4	
10-inch	-	-	70 ,, P. or 60 lb. R.L.G.	-	1550	6	4	
			44 ,, P. or 40 lb. R.L.G.	-	1025	6	4	
9-inch	-	-	50 ,, P. or 43 lb. R.L.G.	-	1350	6	4	
			30 ,, R.L.G.*	-	-	820	4	4
8-inch	-	-	15 ,, R.L.G. or L.G. Exercise	-	-	370	3	4
			35 ,, P. or 30 lb. R.L.G.	-	-	1300	5	4
7-inch	-	-	20 ,, R.L.G.*	-	-	570	4	4
			12 ,, R.L.G. or L.G. Exercise	-	-	450	3	4
64-pr.	-	-	30 ,, P. or 22 lb. R.L.G.	-	-	1100	5	3
			14 ,, R.L.G.*	-	-	538	3	3
40-pr.	-	-	10 ,, R.L.G. or L.G. Exercise (or 32-pr.)	-	-	-	3	16
			10 ,, L.G.	-	-	360	3	3
16-pr.	-	-	8 ,, L.G.	-	-	278	2	3
			6 ,, L.G. (or 32-pr.)	-	-	-	2	8
9-pr.	-	-	5 ,, L.G. Exercise (or 32-pr., or 80-pr.)	-	-	-	1	2
			7 ,, L.G.	-	-	500	4	3
7-pr.	-	-	3 ,, L.G. (Serge)	-	-	320	3	2
			3 ,, L.G. (S. Cloth)	-	-	-	-	14
9-pr.	-	-	1 1/2 ,, L.G. Exercise	-	-	-	12	2
			1 1/2 ,, L.G.	-	-	255	2	2
7-pr.	-	-	1 ,, L.G. Exercise	-	-	-	-	1
			12 oz. F.G.	-	-	100	1	1
7-pr.	-	-	8 ,, F.G.	-	-	50	1	1
			6 ,, F.G.	-	-	50	1	1
7-pr.	-	-	4 ,, F.G.	-	-	50	1	1

\* L.G. is used in the L.S. for full charges of Woolwich guns under 10".

Breech-loading.

Description.	Making, Empty.					Filling and Completing.	
	Braid, Worsted, Blue, Narrow.	Worsted, White, No. 20.	Worsted, White, No. 14.	Silk, Sewing.	Thread, Pack, Kitted.	Worsted, White, No. 14.	Thread, 3 Cord.
	yards.	oz.	oz.	oz.	oz.	oz.	oz.
7-in.	11 lb. L.G.	-	-	450	4	7	-
	10 ,, L.G.	-	-	450	4	7	-
64-pr.	7 ,, Exercise L.G.	-	-	200	3	-	3
	9 ,, L.G.	-	-	540	4	-	1
40-pr.	5 ,, Exercise L.G.	-	-	200	3	-	3
	5 ,, S.S. L.G.	-	-	365	4	-	6
20-pr.	5 ,, L.S. L.G.	-	-	438	4	-	1
	3 ,, Exercise L.G.	-	-	142	2	-	2
12-pr.	2 1/2 ,, L.G.	-	-	340	3	-	1
	1 1/2 ,, Exercise L.G.	-	-	128	2	-	1
9-pr.	1 1/2 ,, L.G.	-	-	215	2	-	1
	1 ,, Exercise L.G.	-	-	320	1	2	4
9-pr.	1 2/8 lb. L.G.	-	-	160	2	-	1
6-pr.	12 oz. L.G.	-	-	144	2	-	1
	10 ,, Exercise L.G.	-	-	156	1	-	2

## SMOOTH-BORE ORDNANCE.

## CHARGES, BURSTING,—APPROXIMATE.\*

Nature of Shell.	Description of Shell.						Number of Calico and Paper Bags.
	Common.	Naval.	Mortar.	Shrapnel Disphragm.	Hand Grenades.		
					Sea Service.	Land Service.	Di-phragm.
	lb. oz. dr.	lb. oz. dr.	lb. oz. dr.	drs.	oz.	oz.	No.
13-inch - -	—	—	10 15 0	—	—	—	—
10-inch - -	6 12 0	6 5 0	5 4 0	—	—	—	—
8-inch, or 68-pr.	2 9 0	2 9 0	2 9 0	80	—	—	—
100-pr. - -	—	3 13 0	—	96	—	—	—
56-pr. - -	2 7 0	—	—	70	—	—	—
42-pr. - -	1 12 0	—	—	60	—	—	—
32-pr. - -	1 5 0	1 5 0	—	50	—	—	—
24-pr., or 5½-inch	1 0 0	—	1 0 0	40	—	—	3
18-pr. - -	0 12 0	—	—	30	—	—	2
12-pr., or 4¾-inch	0 7 0	—	0 7 0	24	—	—	2
9-pr. - -	—	—	—	18	—	—	1
6-pr. - -	—	—	—	10	5	—	1

\* All smooth-bore shells are now filled by capacity instead of by weight, and the charges here given, except in the case of Shrapnel, are taken from W.O.C. 927, the shells being filled in accordance with § 954; also W.O.C. 884; and Royal Artillery Circular *Memo.* 13th December 1864, paragraph 3; "the shell being tapped with a mallet during the process."

The approximate amount of powder required was determined by an experiment in the Royal Laboratory, in 1865, when 10 shells of each nature were filled, and the quantities given above are slightly in excess of the mean result of this experiment, to give even weights; and "it is assumed that as shells of small and large capacity are supplied in about equal proportions, the powder saved in the one case will suffice to make up the deficiency in the others."—W.O.C. 927.

An allowance must be made for displacement by the fuze.—*See also* § 1116.

Thus the 13-inch mortar shell will take approximately 10 lb. 15 oz. of powder without a fuze, and 10 lb. 14 oz. 8 dr. with a fuze. In the case of the Shrapnel shell the charge is the minimum sufficient to open them, and is either weighed or measured. For field service the weighed or measured charge is issued in paper and calico bag as above.

## SERVICE FUZES.—SMOOTH-BORE AND RIFLE.

SHELL.	Gauge.	Fuzes.		REMARKS.
		Time.	Percussion.	
<b>SMOOTH-BORE.</b>				
Mortar, 13", 10", 8" -	Large mortar.	Large mortar.	—	
Diaphragm Shrapnel (except 100-pr.)	Common	Diaphragm Shrapnel.	—	
Common, and 100-pr. Shrapnel.	"	Common - - -	Pettman L.S., except 100-pr. Shrapnel.	The Diaphragm Shrapnel fuze would do for short ranges.
Common, 24 and 12 prs. when fired from 5½" and 4½" mortars.	"	Small mortar, common	- - -	The common fuze would be used up to 10 seconds.
Naval, 100-pr., 10", 8", or 68-pr., 32-pr.	G.S.	9 and 20 seconds M.L., I.	Pettman G.S.	Any of the other Marks of M.L. time fuzes, also the B.L. time fuzes could be used according to range.

## RIFLE B.L.

Common, 7", 64-pr., 40-pr., and 20-pr. S.S.	G.S.	} 9 and 20 seconds B.L. - { } 9 seconds B.L. - - { } 5 and 9 seconds B.L. - - { } E time (S.S. only) - - - {	- { - { - { - {	Pettman G.S. and R.L., Screw II. R.L., Screw II. E.L., Screw II. B.L. plain.
Segment, 7", and 40-pr. Shrapnel, 64 and 40 prs.	"			
Shrapnel, 12 and 9 prs. Segment and common, 20, 12, 9, and 6 prs.	Armstrong F.S.			

## RIFLE M.L.

Common, 7" and over -	G.S.	In the S.S. the 9 and 20 seconds M.L., Mark I., may be used with the 7-inch gun, 14 lbs. charge.	Pettman G.S. -	The B.L. fuzes could be used with R.M.L. shell according to the nature of the shell and the range.
Common, 80, 64, and 40 prs.	"	9 and 20 seconds M.L., Marks I., II., or III.	Pettman G.S. and R.L., Screw II.	
Double, 7" - -	"	In the S.S. the 9 seconds M.L., Mark I., may be used with the 7-inch gun, 14 lbs. charge.	Pettman G.S.	
Shrapnel, 7" and over, S.S. only.	"	9 seconds M.L., Mark I. -	- - -	Mark III. will be the only M.L. fuzes manufactured in future for L.S. and boat service in the navy. Mark I. will be retained for S.S., except boat service.
Shrapnel, 80, 64, and 40 prs.	"	5 and 9 seconds, M.L., Marks I., II., or III.	R.L., Screw Mark II.	
Common, 16, 9, and 7 prs.	"	9 seconds M.L., Marks II. or III.	R.L., Screw II. for 16-pr., I. or II. for 9-pr. and 7-pr.	
Double, 7-pr. - -	"	9 or 20 seconds M.L., Marks II. or III.	—	
Shrapnel, 16, 9, and 7 prs.	"	5 and 9 seconds M.L., Marks II. or III.	R.L., Screw Mark II. for 16-pr., I. or II. for 9-pr. and 7-pr.	
Star, 7-pr. - -	"	5 seconds M.L., Marks II. or III.	—	

N.B.—In substituting any time fuze for another, care must be taken that the top side hole does not appear above the mouth of the fuze hole, as the flash of discharge might enter.

PROPORTION per cent. of PROJECTILES and FUZES issued for each nature of Rifled Gun, Garrison Service, as per Army Circular, January 1873, and Cl. 40. A. C. 173.\*

NATURE OF GUN.	Projectiles.							Fuzes.														
	Shell.					Shot.	Percussion.		Time.													
	Common.	Double.	Shrapnel.	Segment.	Palliser.		Palliser.	Case.	Pettman's G.S.		5 seconds.	9 seconds.	20 seconds.									
						R.L.			Screw II.	Sea Fronts only.				Land Fronts only.	Land Fronts only.	Sea Fronts.	Land Fronts.	Sea Fronts.	Land Fronts.			
R.M.L.	12" { 35 tons	-	-	-	-	-	-	-	-	-	-	-	-	-	-	-	-	-	-	-	-	-
	11" { 25 "	-	-	-	-	-	-	-	-	-	-	-	-	-	-	-	-	-	-	-	-	-
	10" -	-	-	-	-	-	-	-	-	-	-	-	-	-	-	-	-	-	-	-	-	-
	9" -	-	-	-	-	-	-	-	-	-	-	-	-	-	-	-	-	-	-	-	-	-
	7" -	-	-	-	-	-	-	-	-	-	-	-	-	-	-	-	-	-	-	-	-	-
	80-pr.	-	-	-	-	-	-	-	-	-	-	-	-	-	-	-	-	-	-	-	-	-
64 "	-	-	-	-	-	-	-	-	-	-	-	-	-	-	-	-	-	-	-	-	-	
R.B.L.	7" -	-	-	-	30	-	-	10	60	-	-	30	65	20	35	-	-	-	-	-	-	-
	64-pr.†	-	-	-	-	-	-	-	-	-	-	-	-	-	-	-	-	-	-	-	-	-
	40 "	-	-	-	30	-	-	10	60	-	-	30	65	20	35	-	-	-	-	-	-	

\* By Clause 154 A.C. /73 the scale of ammunition for 10", 9", and 7" guns in fortresses at home has been increased to 150 rounds per gun.

† There are only a few 64-pr. B.L. guns mounted, for which there is a special detail of equipment.

## LIST OF CYLINDERS, TIN, FOR FUZES, TUBES, &amp;c., &amp;c.

CYLINDERS, TIN, TO HOLD	No. of Articles in Cylinder.	No. of Cylinder stamped on Base.	External Dimensions.			
			Length.	Diameter.		
			Inches.	Inches.		
Caps, Percussion.	2000, 880, 825, 770, or 850	1	5.0	4.2		
	1386, 1364, 1050, 900, 880, 770, or 750	2	4.75	5.0		
	1350, 1200, 1125, or 825	3	7.75	4.2		
Detonators	1980 or 1,500	4	13.75	4.2		
	1000	26	4.0	4.4		
	990	14	5.4	4.5		
	Bickford Fuze, No. 8 - 25	25	8.8	3.1		
	Electric, {	Abel, (No. 5) - 25	23	5.2	3.2	
		Platinum Wire, (No. 7) - 25	24	8.9	4.4	
		Submarine, (No. 6) 25	24	"	"	
	Fuzes	Bickford (No. 9), repacked, 8 fathoms -	18	2.3	5.0	
		Electric {	Abel, (No. 1) - 25	9	1.4	4.4
			Platinum Wire, (No. 3) - 25	22	6.3	3.2
Submarine, (No. 2) - 25			22	"	"	
Percussion {		Pettman G.S. or L.S. - 5	20	2.3	2.3	
		R.L. Screw - 5	33	1.7	4.2	
Time, Boxer		Common - 5	7	3.5	2.7	
			Diaphragm - 5	8	2.3	2.8
		B.L., 5 secs. or 9 secs. - 5	5	4.3	3.1	
		" 20 " - 5	6	5.9	2.8	
		M.L., 5 secs. or 9 secs. - 5	10	3.9	3.1	
Primers		" 20 " - 5	11	5.5	3.1	
		Coast-guard, with 5 primers - 4	12	10.3	3.7	
	Long, G.S. - 4	13	9.6	4.4		
	Signal, Magnesium - 4	14	5.4	4.5		
	Brass, Shrapnel Shell - 10	31	1.2	1.2		
	Detonating, {	Portfire, L.S. - 10	32	0.8	2.1	
		for lights - 5 or 10	32	"	"	
	Gun-cotton for M.L. fuzes -	21	1.1	3.1		
	Vent Piece - 25	7	3.5	2.7		
	Tubes	Common, Quill - 25	28	1.7	2.3	
Electric, Abel, (No. 4) - 25		18	2.3	5.0		
Friction {		Copper { long - 25	15	5.3	2.8	
		short - 25	16	3.4	2.8	
	7-pr. - 25	17	2.5	2.9		
Quill - {	Waterproof Cartridge - 25	27	5.5	4.5		
	long - 25	18	2.3	5.0		
	short - 25	19	2.3	3.8		
(Torpedoe Stores)	Base plugs - 10	30	2.1	1.9		
Washers, Leather, for	Disconnectors - 10	29	2.1	2.2		
	Fuze plugs - 10	30	2.1	1.9		

N.B.—All the above cylinders would be hermetically closed with a tin strip soldered around junction of lid and cylinder, except Nos. 21 and 22, which are closed with a calico band.



TABLE of BOXES, RIFLE SHELL and SHOT, ROCKETS, and of PACKING-CASES for ROCKETS.

Description.	No. in each Box.	External Dimensions, for Stowage only.			Weight, empty, of Box.	External Marks.	
		Length.	Width.	Depth.			
Shrapnel R.M.L.	12" 35 ton G.	1	42	14 $\frac{3}{4}$	16 $\frac{1}{2}$	61 0	For Patt. I. Shell. " II. "
	12" 25 "	1	38	14 $\frac{3}{4}$	16 $\frac{1}{2}$	56 0	
	12" 25 "	1	37	14 $\frac{3}{4}$	16 $\frac{1}{2}$	61 0	
	10" - -	1	38	12	14	43 0	
	9" - -	1	32	11	13	36 0	
	8" - -	1	28	10	11	26 $\frac{1}{2}$ 0	
	7" - -	1	24	9 $\frac{1}{4}$	9 $\frac{3}{4}$	16 0	
	80-pr.	1	20	8	9	13 0	
	64 "	1	18	8	8 $\frac{3}{4}$	11 $\frac{1}{2}$ 0	
	40 "	2	18	12	7	14 2	
16 "	6	18	11	12 $\frac{3}{4}$	21 6		
9 "	8	20	10	10 $\frac{1}{2}$	18 $\frac{1}{2}$ 0		
7 "	10	24	10 $\frac{1}{4}$	9 $\frac{1}{4}$	20 2		
Common R.M.L.	16 "	6	18 $\frac{1}{4}$	11 $\frac{1}{4}$	12 $\frac{3}{4}$	21 6	
	9 "	8	20	10 $\frac{1}{4}$	10 $\frac{3}{4}$	18 $\frac{1}{2}$ 0	
	7 "	10	24	10 $\frac{1}{4}$	9 $\frac{1}{4}$	20 2	
Case R.M.L.	16 "	6	18 $\frac{1}{4}$	11	9 $\frac{1}{2}$	16 $\frac{3}{4}$ 0	
	9 "	8	20	9 $\frac{1}{2}$	11	19 0	
	7 "	10	24	10 $\frac{1}{4}$	7 $\frac{1}{4}$	18 6	
Shrapnel B.L.	12 "	6	16	10 $\frac{1}{4}$	11	15 14	
	9 "	8	20	10 $\frac{1}{4}$	9 $\frac{3}{4}$	17 10	
Common B.L.	12 "	6	16	10 $\frac{1}{4}$	11	15 14	
	9 "	8	20	10 $\frac{1}{4}$	9 $\frac{1}{4}$	15 12	
Case B.L.	12 "	6	16	10 $\frac{1}{4}$	11	15 14	
	9 "	8	20	10 $\frac{1}{4}$	9 $\frac{1}{2}$	16 14	
Rocket, S.S., for 24-pr. Hale's Rocket	6	28 $\frac{1}{2}$	14 $\frac{1}{2}$	10 $\frac{1}{4}$	44 0		
Rocket, L.S., for 9-pr. Hale's Rocket	4	10 $\frac{1}{4}$	8 $\frac{1}{4}$	18 $\frac{3}{4}$	14 8		
Boxes, Packing, Cases, Packing,	For Hale's Rockets, 9-pr.	12	17 $\frac{3}{4}$	10 $\frac{3}{4}$	19 $\frac{3}{4}$	25 8	
	For Signal Rockets, 1 lb.	60	36 $\frac{1}{2}$	14	12 $\frac{3}{4}$	32 2	
	For Signal Rockets, $\frac{1}{2}$ lb.	96	25	14 $\frac{1}{4}$	15 $\frac{1}{4}$	25 0	
	For Signal Rockets, Coloured, 1 lb.	16	20 $\frac{1}{4}$	13	12	16 0	
	For Rockets, Life saving, 12-pr.	6	30 $\frac{1}{2}$	14 $\frac{3}{4}$	10 $\frac{1}{4}$	26 8	
Boxes, Packing, Cases, Packing,	For 9" or 5" M.L. time fuzes, 30 in 6 tin cylinders	-	12 $\frac{3}{4}$	8 $\frac{1}{8}$	5 $\frac{5}{8}$	5 2	
	For R.L. screw percussion fuzes, 30 in 6 tin cylinders	-	10 $\frac{7}{8}$	7 $\frac{1}{8}$	5 $\frac{5}{8}$	4 6	
	For copper friction tubes (short), 100 in 4 tin cylinders	-	8 $\frac{1}{2}$	7 $\frac{1}{4}$	4 $\frac{3}{4}$	2 14	
	Machine, Rocket, Hale's, 9-pr.-	-	45 $\frac{3}{4}$	7 $\frac{1}{4}$	8	24 4	

## ANALYSIS OF METAL.

Proportions according to Specifications.		Proportions according to Specifications.	
No. 1.—Copper	90.96	Studs, R.M.L. projectiles, *16, 40 and 25-pr. and 7" and over.	
Tin	8.27		
Zinc	0.77		
<i>Pettman L.S.</i> , body, top, and bottom plug.		No. 7.—Copper	9.786
<i>Pettman G.S.</i> , body and top plug.		Zinc	.214
No. 2.—Copper	87.5	Studs, 80-pr. R.M.L.*	
Tin	12.5	No. 8.—Zinc	100.0
<i>Pettman L.S. and G.S.</i> , steady, and cone plugs and ball.		Studs, 7 and 9-pr. projectiles.	
No. 3.—Pure Lead	100.0	No. 9.—Copper	98.80
<i>Pettman L.S. and G.S. cups.</i>		Tin	5.77
No. 4.—Copper	77.11	Zinc	1.98
Tin	1.20	Detonator, B.L. fuzes, Plug, M.L. fuzes.	
Zinc	19.27	No. 10.—Copper	86.96
Lead	2.40	Tin	3.62
<i>E, Time fuze</i> , body, cap, screw, plug, pellet (II. and III.) and nut (II. and III.)		Zinc	5.80
No. 5.—Lead	50.0	Lead	8.62
Tin	50.0	B.L. plain fuze, body, bot- tom plug, and guard.	
Pellet of B.L. plain, and R.L. screw percussion fuzes.		No. 11.—Copper	84.51
No. 6.—Copper	90.90	Tin	4.98
Tin	9.09	Zinc	5.68
		Lead	4.98
		R.L. percussion fuze, body, bottom plug, guard.	

\* The studs for the 64-pr. R.M.L. are stamped from rods of pure copper, also those for 16-pr. Shrapnel, Mark II.

## INDEX.

	Page
Abbreviations, list of - - - - -	1
Adapters, shell, G.S., fuze hole, rifled - - - - -	16
"    "    "    "    spherical - - - - -	16
Advantages gained by rifling, with reference to fuzes and projectiles - - - - -	94
Alderson's shot and shell, steel - - - - -	149
Alloys, table of - - - - -	311
"    studs, projectiles, Woolwich guns - - - - -	141
Ammunition, rifled ordnance, introduction to - - - - -	94
"    B.L. guns, general remarks on - - - - -	99
"    Woolwich guns, general remarks on - - - - -	138
"    80-pr., 64-pr. (shunt and converted) and 40-pr. R.M.L. guns, general remarks on - - - - -	190
"    16, 9, and 7-pr. R.M.L. guns, general remarks on - - - - -	204
"    B.L. small arm, general remarks on - - - - -	216
"    hints for examination of - - - - -	269
Apparatus for proving tubes, primers, and detonators of fuzes - - - - -	76
Antimony, sulphide of - - - - -	13
Attachment of lead coat, B.L. projectiles - - - - -	101
Bags, calico, metal lined, and pentagon cases - - - - -	59
"    serge, blue, for 15 blank 3½ dram cartridges as primers for B.L. F.S. guns - - - - -	132
"    canvas, instrument, extracting projectiles - - - - -	176
"    iron, cylinder, canvas and flannel, half and quarter - - - - -	65
"    serge, bursting charge, efficiency against premature explosions - - - - -	25
"    "    "    "    common shell, Woolwich guns - - - - -	151
"    "    "    "    Palliser shell - - - - -	163
"    worsted shalloon, for blowing charges, 4-oz., 3-oz. - - - - -	86
"    calico, for blowing charges, R.M.L. common shell - - - - -	95
"    paper, waterproof, Armstrong fuzes, percussion and time - - - - -	35, 45
"    jute, use of obsolete - - - - -	96
Balls, light, ground - - - - -	88
"    "    parachute, Boxer - - - - -	88
"    smoke - - - - -	90
Barrels, ammunition, gun, whole and half - - - - -	61
"    budge - - - - -	64
"    cartridge, half, quarter, eighth - - - - -	64
"    powder, whole, half, quarter - - - - -	64
"    heading and unheading - - - - -	66
Battery, galvanic, Walker's, instructions for use - - - - -	74
Bearers, shell or shot, spherical - - - - -	82
Blind shell - - - - -	23
Blowing charges, mortar shell - - - - -	86
"    "    common shell, R.M.L. guns - - - - -	95
Board of Trade coloured rockets - - - - -	237
"    "    life-saving rocket apparatus and stores - - - - -	239
Borers, gimlet, with bits and shields - - - - -	56
Bottoms, wood, shell, or shot, elm or teak, conical - - - - -	91
"    "    "    "    "    cylindrical - - - - -	91
"    "    "    "    "    hemispherical - - - - -	91
"    "    "    "    "    mortar - - - - -	91
"    "    "    "    "    naval - - - - -	91
Boxes, tin, travelling carriage, fuze, 9-pr., 12-pr., or 20-pr. B.L. plain - - - - -	45
"    "    "    "    "    axletree, cartridge, 16-pr. and 9-pr. R.M.L. "    "    "    "    "    R.M.L., R.L. percussion - - - - -	46
Boxes, tin, fuze, Armstrong time - - - - -	35
"    "    "    B.L. plain percussion - - - - -	45
"    "    "    diaphragm shrapnel - - - - -	28
"    "    "    common - - - - -	28
"    "    "    tube, garrison service - - - - -	70

	Page
Boxes, wood, ammunition, small arm, with tin lining - - -	64
"  "  "  "  "  "  "  Adams revolver - - -	64
"  "  "  "  "  "  "  camel - - -	64
"  "  "  "  "  "  "  bullock - - -	64
"  "  cartridge, gun - - -	61
"  "  shrapnel shell, Woolwich guns - - -	155, 310
"  "  "  "  80, 64, and 40-pr. R.M.L. - - -	310
"  "  stores for life-saving apparatus - - -	244
"  "  and cases, packing, table of - - -	310
Breech-loading system, general remarks on - - -	99
Bullet, shell - - -	204
Burning of fuzes, to time - - -	21, 2
"  "  effect of age on - - -	19
"  "  "  firing from guns of various calibres - - -	21
"  "  "  altitude on - - -	21
"  "  rockets to time - - -	271
Burst of segment shell in action - - -	105
"  shrapnel compared with segment - - -	108
Bursting charges, diaphragm shrapnel, regulations for - - -	87
"  "  S.B., table of - - -	306
"  "  protection against premature explosion - - -	94
"  "  rule for - - -	51, 94
Bursters, iron, B.L. segment shell - - -	103
"  "  "  "  "  instructions for alteration of - - -	268
Cage, metal, cylinders, zinc, cartridges, Woolwich guns - - -	62
Calibres, S.B. guns - - -	82
"  B.L. guns - - -	100
"  Woolwich guns - - -	147
"  80, 64, and 40-pr. R.M.L. guns - - -	194, 192, 196
"  16, 9, and 7-pr. "  "  - - -	204
Cap composition - - -	296
Carcasses - - -	87
Cartridges, calico bursters - - -	65
"  cannon, experience with serge and silk cloth as a material for - - -	180
"  "  S.B., general remarks - - -	92
"  "  "  filled, table of - - -	300
"  "  "  empty, issue of - - -	93
"  "  B.L., general remarks - - -	128
"  "  "  experience as to keeping - - -	136
"  "  "  filled, service, table of - - -	134
"  "  "  "  blank, "  - - -	134
"  "  "  empty, issue of - - -	130, 138
"  "  Woolwich guns, general remarks - - -	178
"  "  "  "  filled, battering and full, table of - - -	184
"  "  "  "  "  reduced, - - -	187
"  "  "  "  "  empty, issue of - - -	188, 186
"  "  "  "  "  howitzer, 8' - - -	183
"  "  80, 64, and 40-pr. R.M.L., general remarks - - -	201
"  "  "  "  "  filled, service, table of - - -	202
"  "  "  "  "  "  blank, "  - - -	202
"  "  "  "  "  "  empty, issue of - - -	201
"  "  16, 9, and 7 pr. R.M.L., general remarks - - -	214
"  "  "  "  "  filled, service, table of - - -	215
"  "  "  "  "  "  blank - - -	215
"  "  "  "  "  "  empty, issue of - - -	214
"  "  proof charges - - -	189
"  silk cloth, regulations for issue of - - -	98, 264
"  drill, raw hide, S.B. - - -	93
"  "  "  Woolwich guns, and table of - - -	189, 188
"  "  "  80, 64, and 40-pr., R.M.L., and table of - - -	201, 203
"  "  "  16 and 9-pr., R.M.L. "  "  - - -	215
"  drill, leather, B.L. - - -	185
"  flannel bags to hold 15 lbs. or under - - -	93
"  S.A. ball, B.L. Snider arm, service - - -	216
"  "  "  "  "  buck shot - - -	218
"  "  "  "  "  Martini-Henry arm - - -	219
"  "  "  "  "  pistol, rifled revolver, Adams, B.L. - - -	219

	Page
Cartridges, S.A., ball, Gatling gun	222
"    "    "    proof of	221
"    "    "    blank, 2½ drs., service, B.L.	218
Cases, powder, metal lined, whole, half, and quarter	59
"    "    "    brass, pentagon, whole and half	59
"    "    "    "    rectangular, plain	59
"    "    "    "    corrugated, A, B, C, and D	60
"    "    "    "    cartridge, leather	65
"    "    "    "    Clarkson's material	65
Centring	140
Charcoal	14
Charge, S.B. ordnance, rough rule for weight of	93
"    "    "    "    guns and mortars	92, 300, 304
"    "    "    "    "    reduced for angles of depression	98
"    "    "    "    service, B.L. guns	127, 134
"    "    "    "    exercise or saluting, B.L. guns	132, 134
"    "    "    "    battering and full, Woolwich guns	178, 184
"    "    "    "    reduced	186, 187
"    "    "    "    service, 80, 64, and 40-pr. R.M.L. guns	201, 202
"    "    "    "    saluting	201, 202
"    "    "    "    service, 16, 9, and 7-prs., R.M.L.	214, 215
"    "    "    "    exercise and saluting, 16, 9, and 7-prs., R.M.L.	214, 215
"    "    "    "    blowing, for shells, R.M.L. guns	95
"    "    "    "    S.B.	84, 86
Chilled iron	157, 160
Chilling of iron for projectiles	157, 160
Chlorate of potash	13
Clearance, meaning of term	140
Clips, lifting, R.M.L. projectiles	96
Cloths, hair	65
Coat of B.L. projectiles	99, 101
Collars, leather, fuze and plug	84
Compositions, laboratory, method of mixing	14
"    "    "    "    combustible, table of	295
Concussion fuze, Freeburn	37
Congreve rockets	223
Coopering, hints on	66
Corks, shell, 13', 10', or 8'	85
Corrugated metal powder cases	60
Covers, paper, cartridge	65
"    "    "    "    waterproof, cartridge	65
"    "    "    "    "    waterproof	183
"    "    "    "    "    R.M.L. guns	130
Cups, tin, B.L. guns	62
Cylinders, zinc, cartridges, Woolwich guns	65
"    "    "    "    iron, conveyance of ammunition by rail	22, 309
"    "    "    "    tin, fuzes, wood	309
"    "    "    "    "    caps, percussion	22, 79, 309
"    "    "    "    "    lights	79, 309
"    "    "    "    "    primers, detonating, for lights	99, 309
"    "    "    "    "    "    shrapnel shell	132, 309
"    "    "    "    "    "    vent piece	22, 70, 309
"    "    "    "    "    "    tubes, friction, copper	22, 71, 309
"    "    "    "    "    "    "    quill	74, 309
"    "    "    "    "    "    "    electric, Abel	243, 309
"    "    "    "    "    "    "    detonating, life-saving rocket	309
"    "    "    "    "    "    "    table of	129, 265
"    "    "    "    "    "    "    paper, B.L. cartridges	130
"    "    "    "    "    "    "    "    instructions for varnishing	130
"    "    "    "    "    "    "    "    copper, cartridge, travelling carriage, axletree, 12 or 9-pr. B.L.	130
Damp magazines, treatment of	275, 288
Designation of gunpowder	5, 282
Detonating compositions, table of	295
Detonators, B.L. time fuzes	31
"    "    "    "    "    "    "    "    proof	266
"    "    "    "    "    "    "    "    electric, Abel, No. 5	73
"    "    "    "    "    "    "    "    "    submarine, No. 6	73

	Page
Detonator, electric, platinum wire, No. 7	73
"    Bickford's fuze, No. 8	78
Discs, lead, for 9-pr. and 12-pr. B.L. segment shell	104
Distinguishing marks, explanation of numeral	96
"    "    projectiles, Woolwich guns	148
"    "    B.L. shell generally	123
Drift, wood, common	48
"    "    G.S.	56
"    "    diaphragm shrapnel, large	48
"    "    "    small	48
Drill shot, rifle, B.L.	128
"    "    Woolwich guns	172
Drivers, screw, diaphragm shrapnel	48
{ large, and primers shrapnel shell	48
{ small	48
 Electric fuzes, tubes, and detonators :—	
No. 1, fuze, Abel	72
No. 2, " submarine	72
No. 3, " platinum wire	72
No. 4, tube, Abel	73
No. 5, detonator, Abel	78
No. 6, " submarine	73
No. 7, " platinum wire	73
No. 8, " Bickford's fuze	73
Equipment, whaling	254
Evidence as to segment shell on active service	105
"    "    shrapnel	208
Examination of ammunition :—	
Gunpowder	269
Cartridges	269
Friction tubes	269
Primers	269
Projectiles	270
B.L. S.A. ammunition	271
Hale's rockets	271
Life-saving rockets	268
Experience with—	
Cartridges, B.L., filled and empty	136
Serge and silk cloth as a material for cartridges	180
Fuzes generally	17
Rockets, war, Hale's	227
"    life-saving	249
Projectiles, B.L. shells, common	114
"    "    "    segment	105
"    "    "    shrapnel	120
"    "    "    shot, case	124
"    Woolwich guns, shell, common	150
"    "    "    "    double	151
"    "    "    "    shrapnel	155
"    "    "    "    Palliser	161
"    "    "    "    shot, case	172
Ammunition, Gold Coast	294
Extractors, fuze, large and small	48
Field service ammunition, B.L.	103, 114, 119, 124
"    "    "    R.M.L.	204
Flanged socket	114
Flight of rifled projectiles	255
"    rockets	225, 249
French system of rifling	204
Friction of powder in rotating shells	25
Fulminate of mercury	13
Funnels, copper, cartridge	92
"    "    shell	51
"    leather, with copper spout	48
{ common { large	48
{ diaphragm { small	48
{ shrapnel { large	48
{ shrapnel { small	48



	Page
Fuze composition - - - - -	19, 295
" hole gauges - - - - -	16
Fuzes, time, general remarks on - - - - -	16
" " instructions for preparation - - - - -	53
" " marking of - - - - -	20
" percussion, general remarks - - - - -	87
" metal, time, advantages claimed for - - - - -	17
" time, B.L. and M.L., experiment showing safety against accidental ignition - - - - -	17, 18
" Bickford's - - - - -	80
" Ord's mining - - - - -	80
" electric, Abel's - - - - -	72
" " submarine - - - - -	72
" " platinum wire - - - - -	72
" concussion, Freeburn's - - - - -	37
" percussion, Pettman, L.S. - - - - -	39
" " " " proof of - - - - -	39, 266
" " " " G.S. - - - - -	40
" " " " proof of - - - - -	42, 266
" " " " directions for securing against damp - - - - -	41
" " " " R.L., marks I. and II. - - - - -	45, 46
" " " " proof of - - - - -	47, 266
" " " " B.L. - - - - -	43
" " " " proof of - - - - -	47, 266
" rocket, life-saving, Boxer - - - - -	36, 243
" time, hand grenade - - - - -	35
" " metal, Armstrong E. - - - - -	34
" " wood, Boxer, 5 seconds B.L. - - - - -	31
" " " " 9 " " - - - - -	82
" " " " 20 " " - - - - -	32
" " " " 5 " M.L. - - - - -	29
" " " " 9 " " - - - - -	30
" " " " 20 " " - - - - -	30
" " " " special, 5, 10, and 15 seconds for 7-pr. R.M.L. gun - - - - -	20
" " " " common - - - - -	28
" " " " diaphragm shrapnel - - - - -	27
" " " " mortar, large - - - - -	27
" " " " " small - - - - -	28
" " " " parachute - - - - -	36
" " " " Manby shot - - - - -	36
" " " " rule for finding length of - - - - -	32, 33
" " " " proof of - - - - -	21
" " " " limits allowed in time of burning, manufacture - - - - -	36
" " " " firemasters instructions for proof - - - - -	266
" " " " rate of burning influenced by age of - - - - -	19
" " " " " by firing from various calibres - - - - -	21
" " " " " by altitude - - - - -	21
" " " " painting of - - - - -	22
" " " " packing of - - - - -	22
" " " " blind shell caused by use of - - - - -	23
" " " " premature explosions caused by use of - - - - -	24
" " " " M.L., importance to be attached to difference between various marks - - - - -	28
" " " " regulations for issue of various marks - - - - -	29
" S.B. ordnance, table of - - - - -	307
" rifled " " - - - - -	307
Fuze implements, sets - - - - -	48
Gas checks - - - - -	169
Gauges, fuze hole and fuzes, table of - - - - -	16
" iron, ring, shell or shot :—	
Spherical - - - - -	90, 299
B.L. - - - - -	123
R.M.L., low over studs, Woolwich guns - - - - -	176
" " " 80, 64, and 40-prs. - - - - -	197
" " " 16, 9, and 7-prs. - - - - -	210
" body and studs, Woolwich guns - - - - -	177
" " " 80, 64, and 40-prs. - - - - -	197
" " " 16, 9, and 7-prs. - - - - -	210

	Page
Gauges, cylinder, shell or shot, R.M.L., body and studs :—	
Woolwich guns - - - - -	176
80, 64, and 40-prs. - - - - -	197
16, 9, and 7-prs. - - - - -	210
Gauge, filled cartridge, brass ring :—	
S.B. - - - - -	93
Rifled gun, B.L. - - - - -	136
" " M.L., Woolwich - - - - -	182
" " " 80, 64, and 40-prs. - - - - -	201
" " " 16, 9, and 7-prs. - - - - -	214
Gauge, filled cartridge :—	
Wood, length, rifled B.L. - - - - -	136
" " universal R.M.L. - - - - -	181
Gauging, spherical common shell for small mortars, 5½" and 4½"	84
Graduation of time fuzes, Boxer's - - - - -	20
" " " Armstrong, E. - - - - -	34
Grease, fuze - - - - -	298
Grooves, Armstrong, B.L. system - - - - -	99
" " M.L. shunt - - - - -	190
" converted R.M.L. guns - - - - -	194
" Woolwich guns - - - - -	188
" 16, 9, and 7-pr. R.M.L. guns - - - - -	204
Grummets, issue of studded projectiles - - - - -	96
Gunpowder, care and stowage of - - - - -	276
" examination and classification of - - - - -	278
" and ammunition, conveyance of - - - - -	284
" composition of - - - - -	3
" general remarks on - - - - -	3
" serviceable classification of - - - - -	4, 278
" pebble, service - - - - -	5, 282
" R.L.G. " - - - - -	6, 282
" L.G. " - - - - -	7, 282
" R.F.G. " - - - - -	7, 282
" R.F.G. 2 " - - - - -	7, 282
" Pistol " - - - - -	7, 282
" R.L.G. and L.G., blank or exercise - - - - -	7, 282
" R.F.G. and F.G., " " - - - - -	7, 282
" L.G., shell - - - - -	8, 282
" F.G. " - - - - -	8, 282
" meal, cylinder - - - - -	8
" " pit - - - - -	8
" from broken up B.L. small arm ammunition and from shell to be wetted - - - - -	5, 277
" liability to explosion from a blow or by friction - - - - -	8
" climate, properties of standing - - - - -	10
" explosive force in confined vessels - - - - -	10
" experiments with L.G. and R.L.G. powder, S.B. guns as to pressure and R.L.G. - - - - -	4 178
Guns, calibres of S.B. - - - - -	82
" " B.L. - - - - -	100
" " Woolwich - - - - -	147
" " 80, 64, and 40-pr. R.M.L. - - - - -	194, 192, 196
" " 16, 9, and 7-pr. " - - - - -	204
Gun cotton, composition, use and action - - - - -	10
" detonation of - - - - -	11
" packing and storing instructions - - - - -	12
" force of, experiments illustrating - - - - -	12
" as priming for time fuzes - - - - -	11, 18
" issue of - - - - -	12, 18
" as bursting charge for shell - - - - -	205
Hale's war rockets - - - - -	227
Handles, lights, long or signal - - - - -	79, 244
Heads of projectiles, form of - - - - -	96, 145
" " Woolwich guns - - - - -	145
" " ogival, volume of - - - - -	145

	Page
Hides, tanned - - - - -	65
Hints on coopering - - - - -	66
Holder, shell, Palliser - - - - -	58, 176
Holes, unloading, rifle common shell - - - - -	95
Hollow-headed and hollow shot, B.L. - - - - -	128
Hooks, hook borer - - - - -	48
" iron, shell, Lewis, beam - - - - -	85
" " " " hand - - - - -	85
" " " lug, beam - - - - -	85
" " " " hand - - - - -	85
Horns, powder, miners - - - - -	57
Implements, fuze and shell, sets, and directions for use - - - - -	50
Ingredients used in laboratory compositions, their properties and method of mixing - - - - -	13
Instruments, extracting projectiles, R.M.L. guns	175
{ Woolwich guns - - - - -	175
{ 64-pr. - - - - -	192
{ 80-pr. - - - - -	196
Instructions, fixing wood bottoms - - - - -	50
" filling, shell, S.B. and rifle - - - - -	51
" preparing B.L. F.S. segment shell - - - - -	52
" boring and fixing fuzes - - - - -	53
" fixing G.S. adapters - - - - -	103
" gauging B.L. projectiles - - - - -	123
" varnishing paper cylinders, B.L. cartridges - - - - -	130
" cementing in wad, fuze hole, G.S., naval, with loop - - - - -	97
" firemasters, proof of tubes, fuzes, primers, &c. - - - - -	266
" Walker's battery, use of - - - - -	74
" scraping, gauging, painting, and piling shot and shell - - - - -	293
" " and painting rockets, war and life-saving - - - - -	231, 268
" use of life-saving rocket - - - - -	244
" examination of ammunition - - - - -	269
" gun cotton primers for fuzes, fixing - - - - -	18
" Royal Artillery in charge of magazines - - - - -	289
" proof of S.A. ammunition - - - - -	221
Integration for forms of heads - - - - -	145
Iron, chilled - - - - -	157, 160
Iron filings in Palliser shell - - - - -	162
Issue (see Packing and issue).	
Key, iron, common plug - - - - -	48
" " fuze and plug, G.S. - - - - -	56
" " plug, G.S. - - - - -	56
" " shell and fuze, Armstrong - - - - -	56
" metal, for powder cases, corrugated - - - - -	60
" " " " metal lined - - - - -	59
Kit plaster - - - - -	86, 297
Lacquer, necessity for in shell - - - - -	24, 94
" black - - - - -	102
" red - - - - -	298
" special, for G.S. percussion fuze - - - - -	298
Lanyards, friction tube, field - - - - -	71
" " " garrison - - - - -	71
" " " naval - - - - -	71
Lead and tin attachment - - - - -	101, 111
" coat of B.L. shells - - - - -	101, 111
" employed in interior of fuzes - - - - -	37
Leader, rockets - - - - -	239
Lights, coast guard - - - - -	78
" long, G.S., or Boxer life-saving - - - - -	78
" signal, magnesium - - - - -	78
" illuminating wrecks - - - - -	78
Lever, cases, brass - - - - -	59
Lubricators, cartridge, B.L. guns - - - - -	128

	Page
Luting, common	59
„ necessity for use with powder cases	59
Machine, rocket, or trough, L.S., Hale's, 24-pr., 9-pr.	233
„ „ or tube signal	238
„ „ „ life-saving	241
„ „ „ war, Hale's, S.S.	234
Magazines :—	
Regulations for Control officers in charge	272
„ „ Royal Artillery officers in charge	289
„ „ ventilation of	275, 288
Damp, treatment of	275
Magnesium	14
Mallets, common and diaphragm shrapnel	49
„ mortar	49
Mark or pattern shown on ammunition by Roman numeral	96
Marks, Armstrong shells, various on filled shell	83, 98
Match, quick and slow	80
Mealed powder	8, 14
Mercury, fulminate of	13
Methylated spirit	14
Monograms on cartridges	58
Numeral (see mark)	96
Orpiment, red	14
Packing and issue :—	
Bags, serge, bursting charge, Palliser shell	163
„ „ „ „ common shell, Woolwich guns	149
Bursting, iron, F.S. segment shell	104
Cartridges, B.L., filled and empty	180, 133, 134
„ Woolwich guns, do.	183, 184, 186
„ 80, 64, and 40-pr. R.M.L., do.	201, 202
„ 16, 9, and 7-pr. R.M.L., do.	214, 215
„ S.B. guns, filled and empty	93, 300
Caps, percussion	296
Cups, tin	130
Cylinders, paper, B.L. cartridges	129
„ zinc, cartridges, Woolwich guns	62
Detonators, Bickford's and electric	309
Fuzes, time, Armstrong, E.	35
„ „ large mortar	27
„ „ diaphragm, shrapnel	28
„ „ common	28
„ „ small mortar	28
„ „ 5 sec. M.L.	31
„ „ 9 „ „	31
„ „ 20 „ „	31
„ „ 5 „ B.L.	32
„ „ 9 „ „	32
„ „ 20 „ „	32
„ „ hand grenade	36
„ percussion, Pettman, L.S.	39
„ „ „ G.S.	42
„ „ R.L. Screw	46
„ „ B.L. plain	47
„ Bickford's and electric	81, 309
Tubes, friction, copper	70
„ „ quill	71
„ detonating, life-saving rocket	75
„ electric, Abel	74
Lights, long, signal, and coastguard	79
Portfires, common	78
Primers, detonating, light, G.S.	79
„ vent piece, B.L. guns	132
„ brass, shrapnel shell	99

	Page
Packing and issue— <i>cont.</i>	
Gun cotton	12
" priming for fuzes	18
Gauges, cartridge, brass ring, S.B.	93
" " " " B.L.	136
" " " " Woolwich guns	182
" " " " 80, 64, and 40-pr. R.M.L.	201
" " " " 16, 9, and 7-pr. "	214
" " wood, sliding, B.L. guns	136
" " " length, universal, R.M.L.	181
Electric fuzes, tubes, and detonators	309
Lubricators, B.L. cartridges	129
Projectiles, S.B. shot, solid	82
" " " case	83
" " " grape	83
" " " pound	83
" " shell, common	85
" " " naval	85
" " " mortar	85
" " " hand grenade	86
" " " diaphragm shrapnel	87
" " " carcasses	88
" " " ground, light balls	88
" " " parachute, "	90
" " " smoke balls	90
" F.S., for India, boxed	96
" B.L., shell, common	115
" " " segment	103, 104
" " " shrapnel	119, 120
" " shot, case	124, 125
" " " solid	128
" Woolwich, shell, common	149
" " " double	150
" " " shrapnel	155
" " " Palliser	161
" " " shot	169
" " " case	172
" 80, 64, and 40-pr. R.M.L. shell, common	192, 196
" " " " " shrapnel	194, 196
" " " " " shot, case	194, 197
" 16, 9, and 7-pr. R.M.L. shell, common	206
" " " " " double	208
" " " " " shrapnel	207
" " " " " shot, case	210
" 7-pr. star shell	209
Rockets, life-saving	310
" signal, or sky	236
" war, Hale's	232
Small arm ammunition, B.L.	218, 219, 220
Paint, projectiles, S.B. and rifle	82, 95
" on empty shell, examined for powder	271, 284
" red, on filled shell	83, 98
" rockets, war, Hale's	231, 298
" " life-saving	240, 298
" table of "	240
Painting shot and shell, instructions for	293
Palliser projectiles, general remarks on	157
" " method of testing	161
" " examination of	270
" " penetration of, rule for	164, 262
" shell	160, 165
" " burster, explosion of, reasons assigned for	163
" shot	166, 170
Paper cylinders, B.L. cartridges	129, 265
Percussion fuzes	37
Plate, stencil, for filled shell	98
Plank, stacking projectiles, Woolwich guns	96

	Page
Plugs, metal, fuze hole, common	84
"  "  "  "  diaphragm shrapnel	86
"  "  "  "  G.S.	98
"  "  "  "  B.L. F.S.	98
"  "  "  "  Moorsom	98
"  wood, covered with serge, segment shell, F.S.	104
"  "  rifle, common shell, fired at practice	95
Pockets, leather, buff, fuze	57
"  "  tube	70
Portfires, life-saving apparatus, Boxer	243
"  common	78
"  life buoy	79
"  miners	78
"  slow or blue	78
Premature explosions in shell	24, 162
Primers, Boxer's, light, G.S.	78
"  "  portfire	243
"  brass, shrapnel shell	98
"  vent piece	132
Practice, rifle shell fired blind	95
"  projectiles, how marked	95, 1
Projectiles, S.B. and rifle, paint of	82, 95
"  Woolwich guns, average weight	148
"  best length for good shooting	95, 144
"  best form of head	145
Proof, tubes and primers	266, 269
"  B.L. S.A. ammunition	271
"  detonators of fuzes	266
"  fuzes, time	266
"  rockets	271
"  firemasters, tubes, primers, fuzes, &c.	266
"  charges, Woolwich guns	189
Recovered shell, directions for use at practice	85, 163
Red orpiment	14
Regulations, magazines in charge of Royal Artillery	289
"  "  "  "  Control officers	272
"  "  laboratory operations	283
"  "  lamps, magazines	292
"  "  making up cartridges, filling shell, &c. by Royal Artillery	290
Rifling, advantages gained by, with reference to fuzes and projectiles	94
Ring gauges, iron, shell or shot, spherical	90, 299
"  "  "  high, shell or shot, R.B.L.	123
"  "  "  shell or shot, R.M.L., low over studs, Woolwich guns	176
"  "  "  "  "  "  "  "  80, 64, and 40-prs.	197
"  "  "  "  "  "  "  "  16, 9, and 7-prs.	210
"  "  brass, filled cartridge :—	
Smooth bore	93
Rifle gun, B.L.	136
"  "  M.L., Woolwich	182
"  "  "  80, 64, and 40-prs.	201
"  "  "  "  16, 9, and 7-prs.	204
Rivets, metal, shell:—	
Common, large, small	91
Naval	91
Rockets, war, general remarks on	223
"  "  Hale's, construction of	227
"  "  "  experience as to firing	232
"  "  "  experiments as to range	228
"  "  "  instructions for examination	230, 271
"  carcass, experimental	233
"  gun cotton	233
"  life-saving, Boxer	239
"  "  miscellaneous stores	241, 243
"  instructions for use of	244
"  examination of	231, 268
"  signal, service	236



	Page
Rockets, signal, coloured, with coloured stars - - - -	237
"  time of burning - - - -	271
Rods, brass, filling, shell - - - -	51
Rosin - - - -	14
Rule for finding length of fuzes, time - - - -	32, 35
"  general, for employment of time fuzes - - - -	33
Saltpetre - - - -	13
Scrapers, copper, shell - - - -	57
Serge, experience with - - - -	180
Setters, common and diaphragm shrapnel - - - -	49
Signal rockets - - - -	236
Silk cloth for cartridges, experience with - - - -	180
Shell, spherical, common - - - -	84
"  "  naval - - - -	85
"  "  mortar - - - -	85
"  "  hand grenade - - - -	86
"  "  diaphragm shrapnel - - - -	86
"  "  improved - - - -	87
"  "  bursting charges, table of - - - -	306
"  rifled, B.L. segment - - - -	102
"  "  "  "  bursting charges - - - -	113
"  "  "  shrapnel, Boxer - - - -	117
"  "  "  "  bursting charges - - - -	122
"  "  "  common - - - -	114
"  "  "  bursting charges - - - -	116
"  "  M.L., Woolwich, common - - - -	149
"  "  "  "  bursting charge - - - -	152
"  "  "  "  double - - - -	150
"  "  "  "  bursting charge - - - -	152
"  "  "  shrapnel, Boxer - - - -	154
"  "  "  "  bursting charge - - - -	156
"  "  "  Palliser - - - -	160
"  "  "  "  bursting charge - - - -	165
"  "  "  "  8' howitzer, common - - - -	174
"  "  "  "  shrapnel, Boxer - - - -	174
"  "  "  80, 64, and 40-prs., common - - - -	192, 194, 196
"  "  "  "  bursting charge - - - -	198
"  "  "  "  shrapnel, Boxer - - - -	193, 196
"  "  "  "  bursting charge - - - -	199
"  "  "  16, 9, and 7-prs., common - - - -	206
"  "  "  "  bursting charge - - - -	211
"  "  "  "  shrapnel, Boxer - - - -	206
"  "  "  "  bursting charge - - - -	212
"  "  "  7-pr. double - - - -	208
"  "  "  "  bursting charge - - - -	208, 211
"  "  "  16-pr., bullet - - - -	204
"  "  "  7-pr., star - - - -	209
Shell, Alderson's, steel - - - -	149
"  recovered, regulations for use - - - -	85, 163
"  shrapnel, storing of - - - -	96
"  rifled, B.L., distinctive features of - - - -	123
"  holder, Palliser - - - -	53, 176
"  instructions for filling - - - -	51
Shot, S.B., solid, spherical, common - - - -	82
"  "  case - - - -	82
"  "  grape - - - -	83
"  "  sand - - - -	83
"  "  hollow - - - -	83
"  "  steel, and chilled - - - -	82
"  pound, for mortars - - - -	83
"  Manby's, cylindrical - - - -	90
"  rifled, B.L. case - - - -	123
"  "  drill - - - -	128
"  "  solid - - - -	128
"  "  M.L., Woolwich, Palliser - - - -	166, 171
"  "  "  "  case - - - -	172

	Page
Shot, rifled, M.L., Woolwich, drill	172
"    "    "    80, 64, and 40-prs. case	194, 196, 197, 200
"    "    "    16, 9, and 7-prs.    "	210, 213
"    Alderson's, steel	149
"    case, rifle guns, rule for weight of	95
Shunt system of rifling, remarks on	190
Small-arm ammunition, B.L., remarks on	216
Smoke balls	90
Sockets, wood and paper, B.L. cartridges	129, 265
Spirits, methylated	14
"    turpentine	14
Stand, light, illuminating wrecks	79
"    for proving tubes and primers	76
"    "    detonators, Pettman and B.L. time fuzes	76
"    "    "    B.L. plain, and R.L. screw fuzes	76
Stencil plate, filled shell	98
Stripping of lead coat	111
Studs, Woolwich guns, general remarks on dimensions, position, &c.	140
"    alloy of metal for	141, 311
"    action of French	204
"    "    shunt	191
"    "    Woolwich	140
"    how fixed in	141
Sulphur	13
Sulphide of antimony	13
Table, bursting charges, S.B.	306
"    proportions, projectiles, and fuzes, rifled ordnance	308
"    cylinders, tin, packing fuzes, tubes, lights, &c.	309
"    boxes, wood, rifle, shell, shot, &c.	310
"    analysis of metal used in alloys	311
"    gauges, iron, ring, S.B. projectiles	299
"    "    "    sand shot	299
"    materials for making up rifled cartridges	305
Table of fuze hole gauges and fuzes	16
"    service fuzes, S.B. and rifle	307
"    B.L. segment shell	113
"    "    Shrapnel	122
"    "    common	116
"    "    case shot	127
"    R.M.L., common and double shell, Woolwich guns	152
"    "    shrapnel	156
"    "    Palliser	165
"    "    "    shot	170
"    "    case	173
"    "    common shell, 80, 64, and 40-pr. guns	198
"    "    Shrapnel	199
"    "    case shot,	200
"    "    common and double shell, 16, 9, and 7-prs.	211
"    "    shrapnel	212
"    "    case shot	213
"    filled cannon cartridges, S.B.	300
"    "    "    B.L., service	134
"    "    "    "    blank	134
"    "    "    Woolwich guns, service	184
"    "    "    "    reduced	187
"    "    "    "    80, 64, and 40-pr., service	202
"    "    "    "    "    blank	202
"    "    "    "    16, 9, and 7-prs., R.M.L., service and blank	215
"    drill cartridges, B.L. guns	135
"    "    Woolwich guns	188
"    "    80, 64, and 40-prs.	203
"    "    16, 9, and 7-prs.	215
"    tin cups, B.L. guns	131
"    zinc cylinders, Woolwich gun cartridges	63
"    B.L. small-arm ammunition	220
"    combustible compositions	295

	Page
Table of paints and non-combustible compositions - - -	297
" charges, S.B. guns and mortars - - -	304
Tops, wood, naval shell - - -	91
Trough or machine, Hale's rocket, L.S. - - -	233
Tray, wood, lifting projectiles - - -	96
Tubes, friction, general remarks - - -	68
" " causes of failure - - -	69
" common quill - - -	71
" paper - - -	72
" match, Fynmore's - - -	72
" dummy, drill - - -	75
" electric, Abel's - - -	73
" friction, copper, service, short - - -	69
" " " " long - - -	69
" " " " waterproof cartridges - - -	69
" " " " 7-pr. R.M.L. - - -	69
" " quill with loops, short - - -	70
" " " " long - - -	71
" rocket, life-saving - - -	75
" Hale's rocket, sea service - - -	285
Turpentine, spirits of - - -	14
Undercut method of attaching lead coat - - -	101
Unloading hole - - -	95
Wadmiltits - - -	65
Wads, coal dust, 8-inch, S.B. - - -	93
" grummet, S.B. - - -	82
" " rifle, M.L. - - -	95
" junk smooth bore - - -	82
" " felt and Bolton - - -	169
" wedge, Woolwich guns - - -	169
" grummet, for issue of studded projectiles - - -	96
" papier mache, common, shell - - -	84
" " " diaphragm shrapnel - - -	52
" " " naval, plain - - -	97
" " " " with loop - - -	97
" fuze hole, rifle shell, G.S. - - -	57
" papier mache, socket, B.L. common shell - - -	114
Windage in S.B. guns - - -	82

## LONDON:

Printed by GEORGE E. EYRE and WILLIAM SPOTTISWOODE,  
Printers to the Queen's most Excellent Majesty.

For Her Majesty's Stationery Office.

[4826.—100.—8/74.]

[P. 1066.—1000.—8/74.]

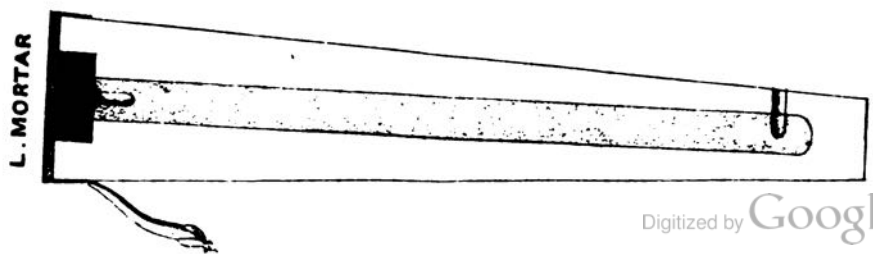

L. MORTAR

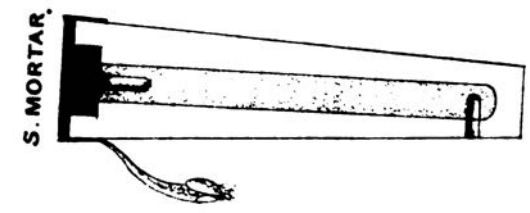

S. MORTAR

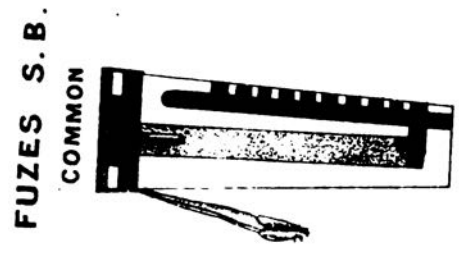

FUZES S. B.  
COMMON

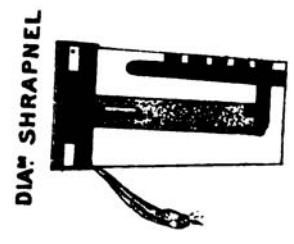

DIA. SHRAPNEL

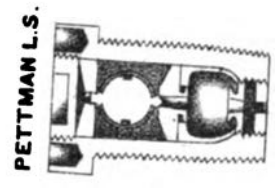

PETTMAN L.S.

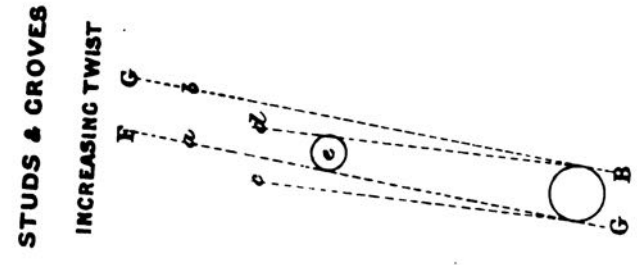

STUDS & GROVES

INCREASING TWIST

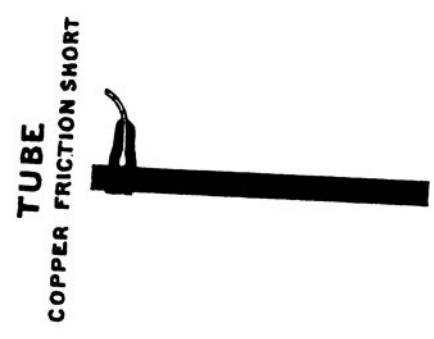

TUBE  
COPPER FRICTION SHORT

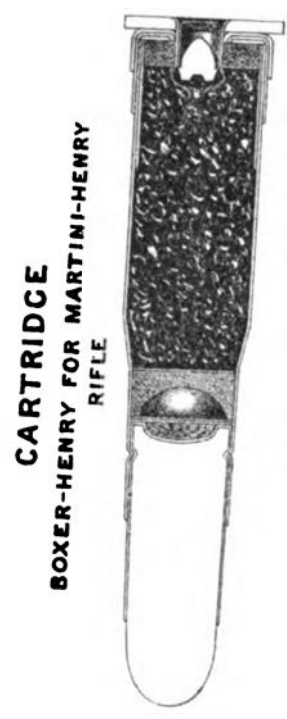

CARTRIDGE  
BOXER-HENRY FOR MARTINI-HENRY  
RIFLE

*F. Dugganfield, 21th 12th Regt. S. Vincent, Garrison, London.*



FUZE TIME WOOD BOXER 5 SECONDS M.L.

III.

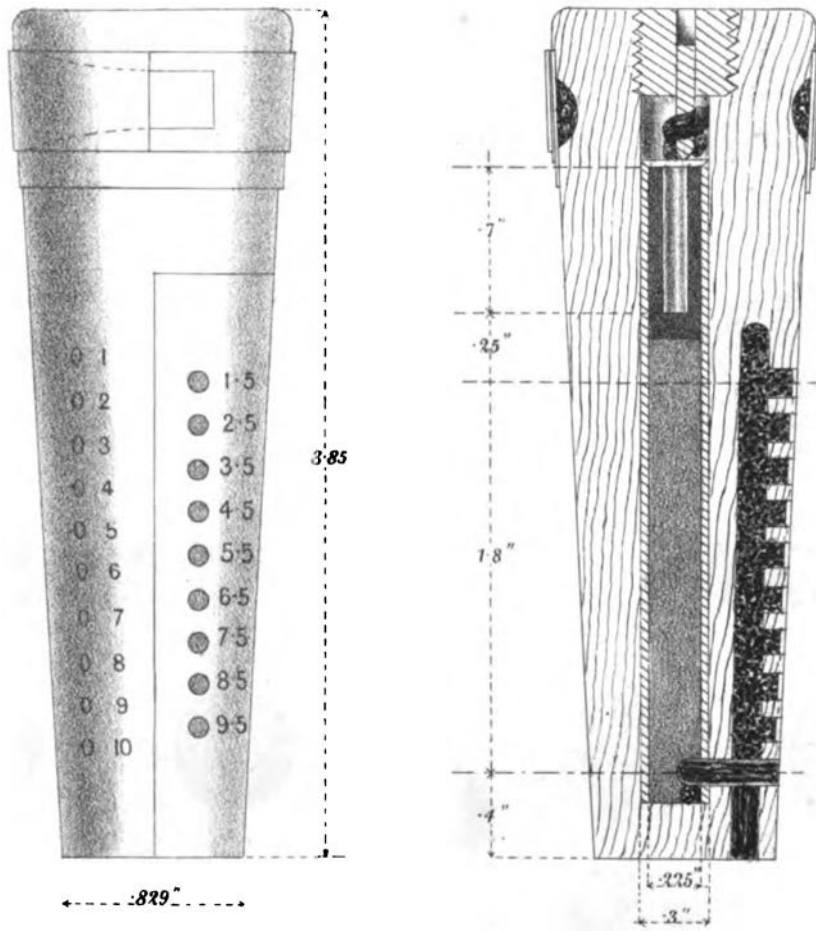





# FUZE PERCUSSION PETTMAN GENERAL SERVICE.

## I

SS1235 & 1634

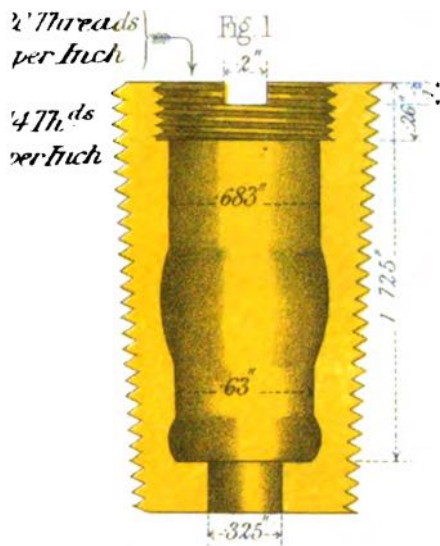

Fig 2

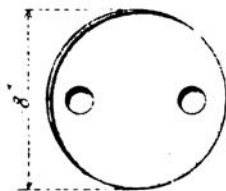

Fig 3



Fig 4

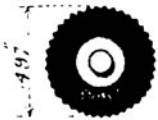

Fig 5



Fig 6



Fig 7

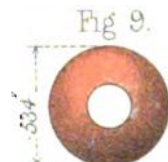

Fig 8



Fig 9

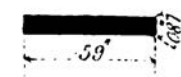

Fig 10



Fig 11



Fig 12

Fig 12



Fig 13



Fig 14

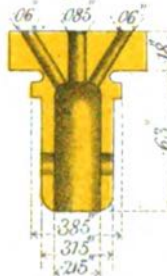

Fig 15



Fig 16



Fig 17

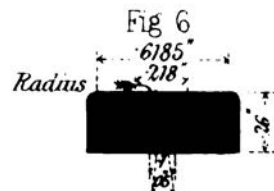

Fig 18



Fig 19



Fig 20



Fig 21



# FUZE PERCUSSION R. L. SCREW.

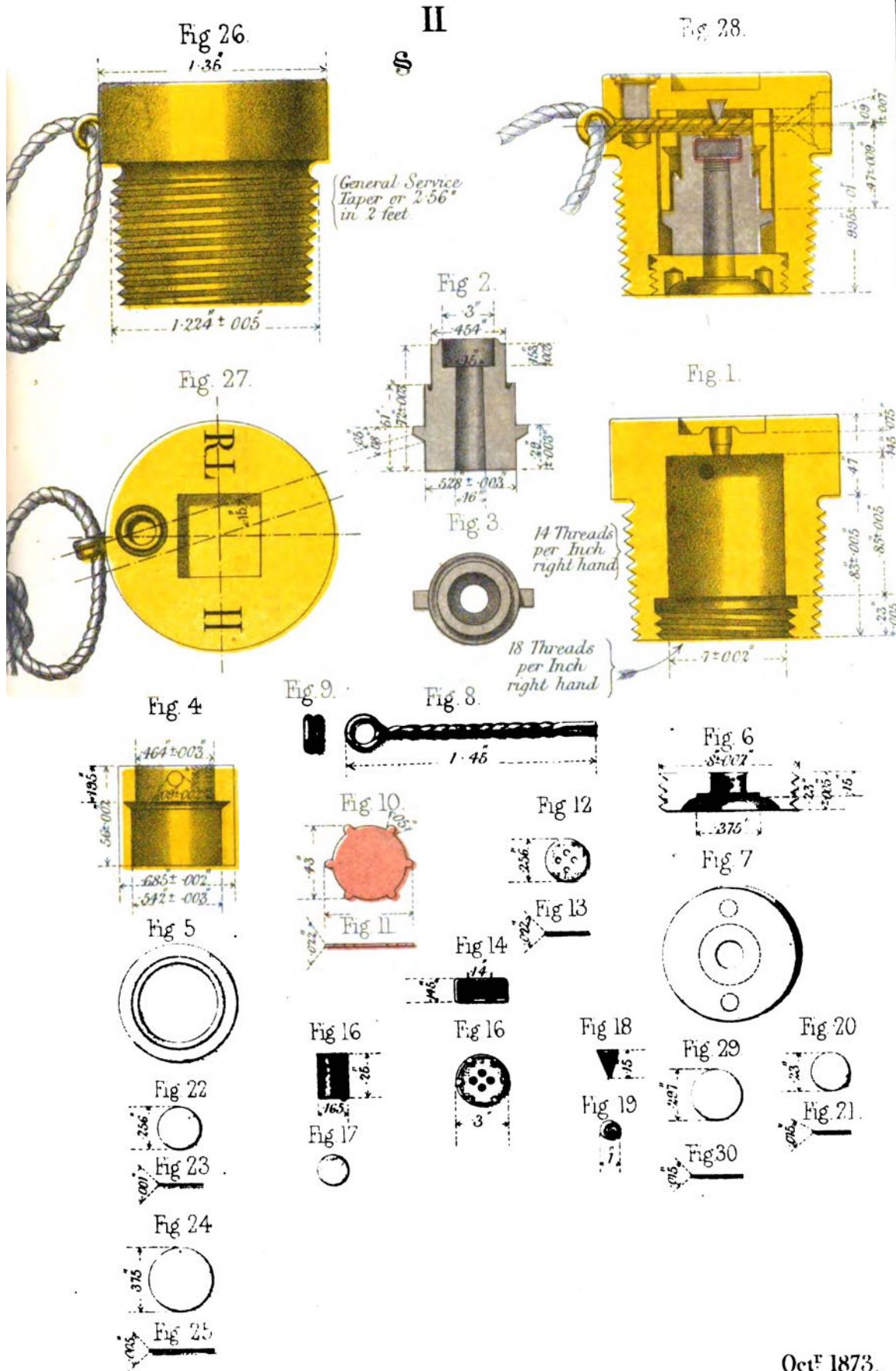

Oct<sup>r</sup> 1873.



12 Pr. BOXER DIAPHRAGM SHRAPNEL SHELL

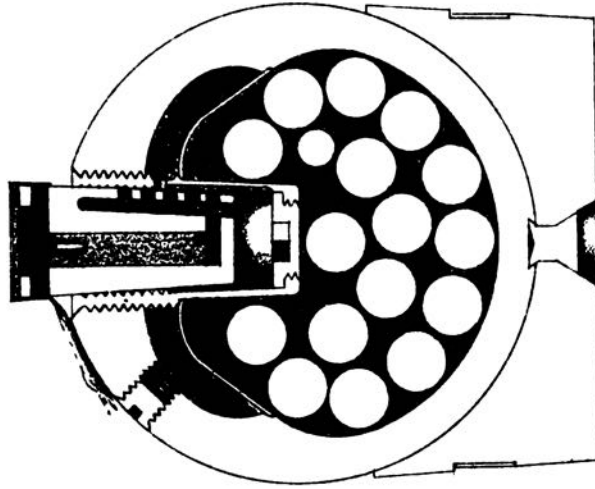

Photographic reproduction of original drawing.

4 1/2 IN. GROUND LIGHT BALL

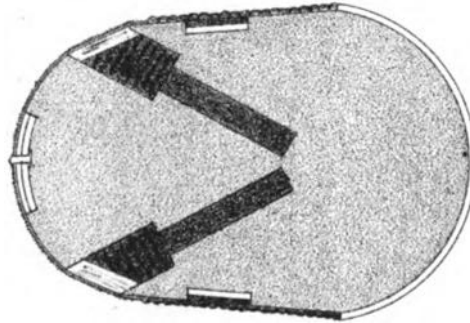

12 Pr. CARCASS

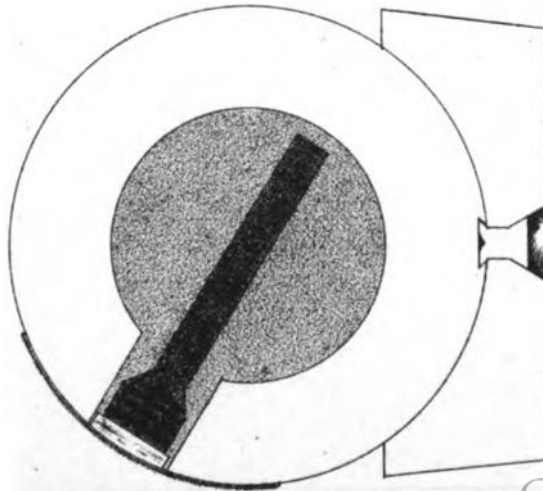





SHELL RIFLED BREECH LOADING SEGMENT 12 P<sup>R</sup>

I.

SCALE ½

Weight 10<sup>lbs</sup> - 8<sup>ozs</sup> ± 4<sup>ozs</sup>.

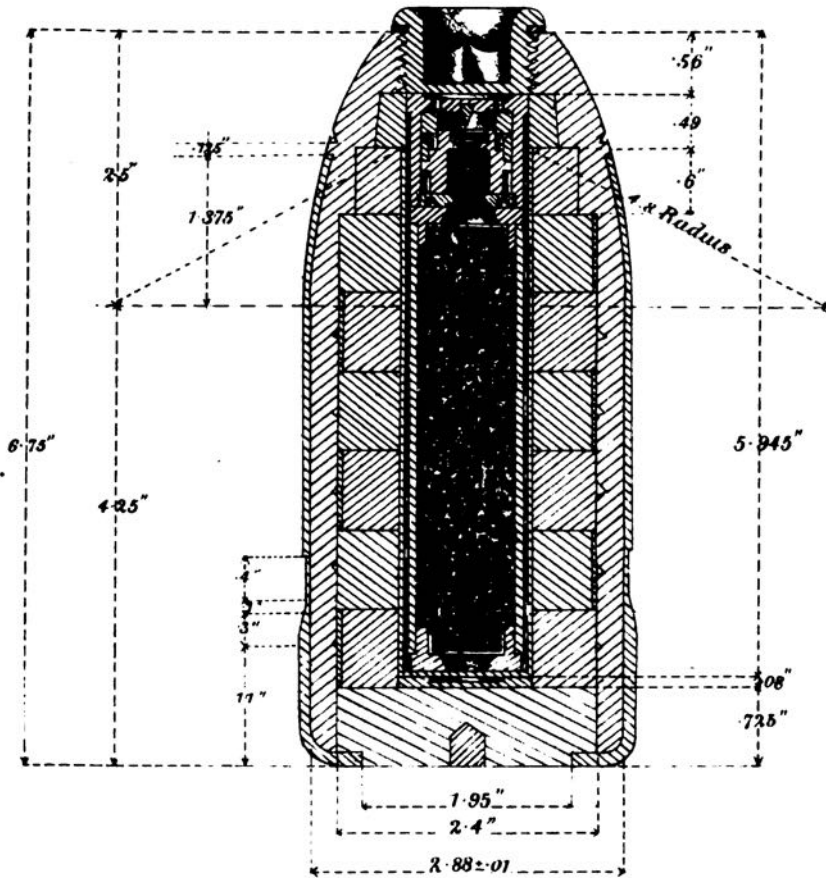

Diameters	High	Low
Back End	3.074	3.067
Body	3.034	3.024
Comm. <sup>1</sup> / <sub>2</sub> of taper	3.015	

*is not to pass on the Body*



# SHELL RIFLED BREECH LOADING COMMON 12 PR

## III

Scale  $\frac{1}{2}$

23 · 2 · 74

WEIGHT LBS OZS  
 CAST IRON ... 10 - 17  
 POWDER ..... 8  
 TOTAL 11 - 4 $\frac{1}{4}$  OZS

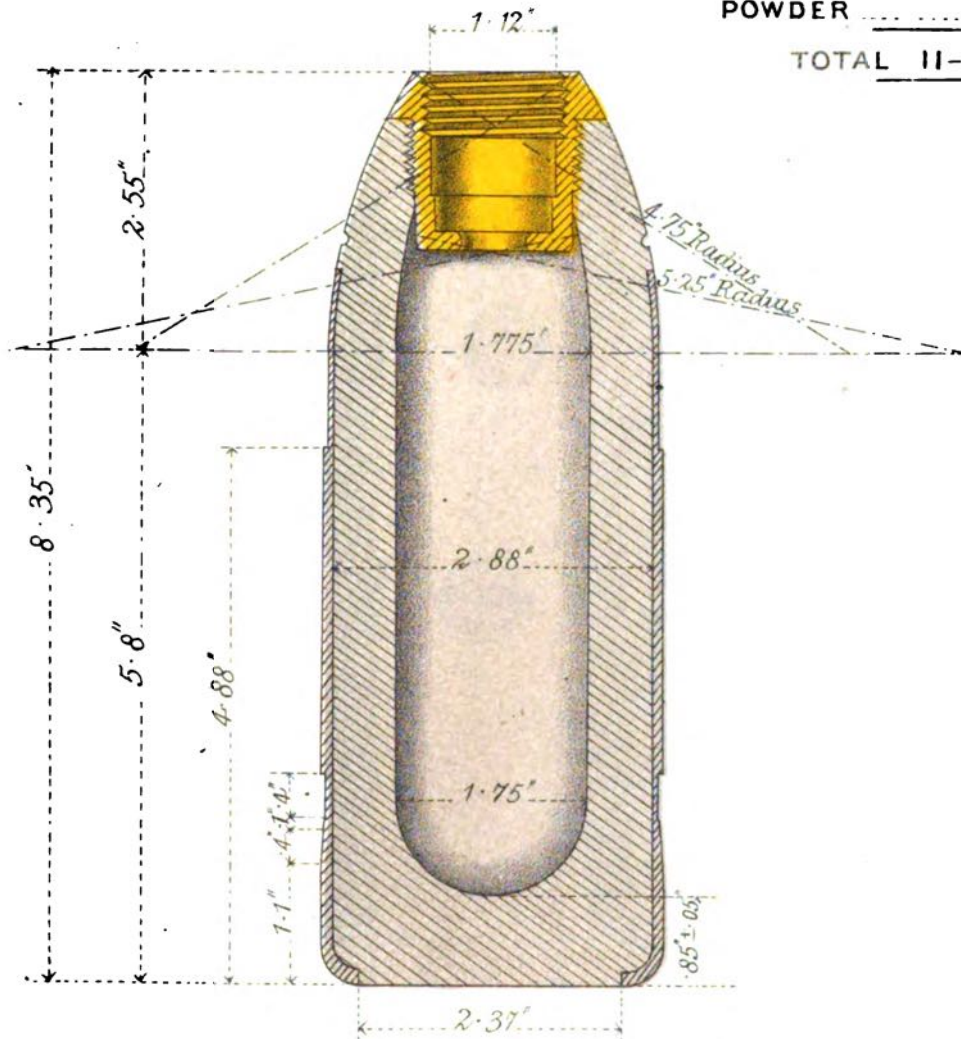

DIAMETERS HIGH LOW  
 BACK END ... 3.074 - 3.067"  
 BODY ..... 3.034 - 3.024"  
 COMM: OF TAPER - 3.015"  
 IS NOT TO PASS ON TO THE BODY



SHELL RIFLED MUZZLE LOADING COMMON.

7 INCH

V  
S 1765

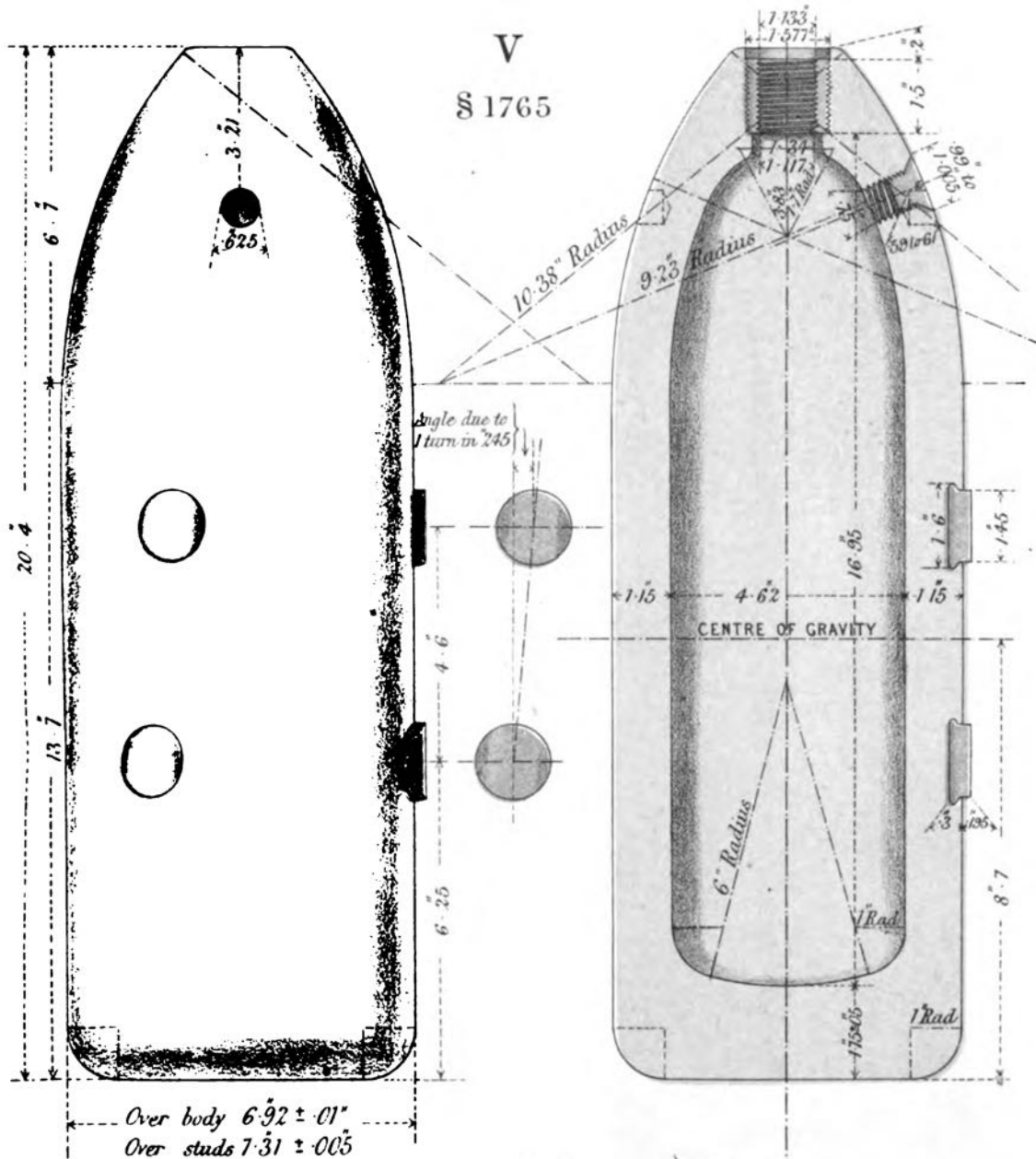

Scale  $\frac{1}{4}$

CAST IRON .....  $\frac{\text{lb.}}{106.75}$   
 POWDER LOOSE ...  $8.25$   
 TOTAL ...  $115.00 \pm 1.5$  PER CENT

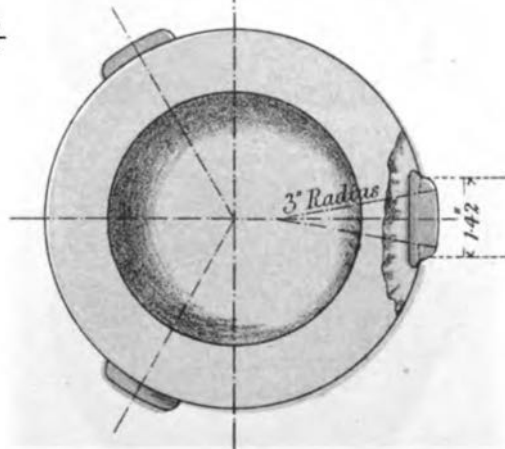









# SHELL RIFLED MUZZLE LOADING BOXER SHRAPNEL.

## 7 INCH

### III

#### § 2366

TOTAL AVERAGE WEIGHT } 118 LB. ± 1.5 PER CENT  
BURSTING CHARGE 12 OZ.

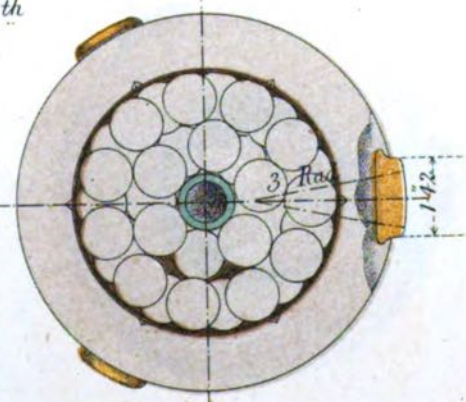
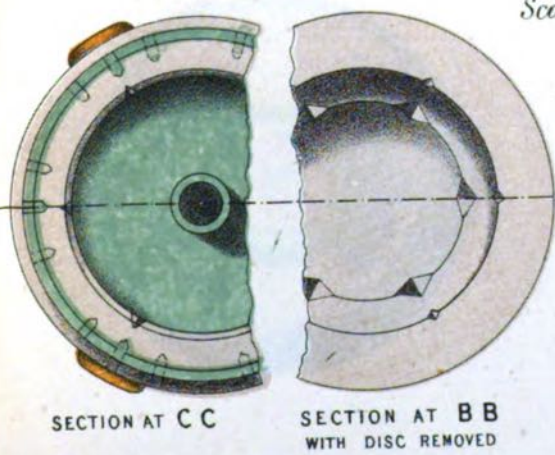
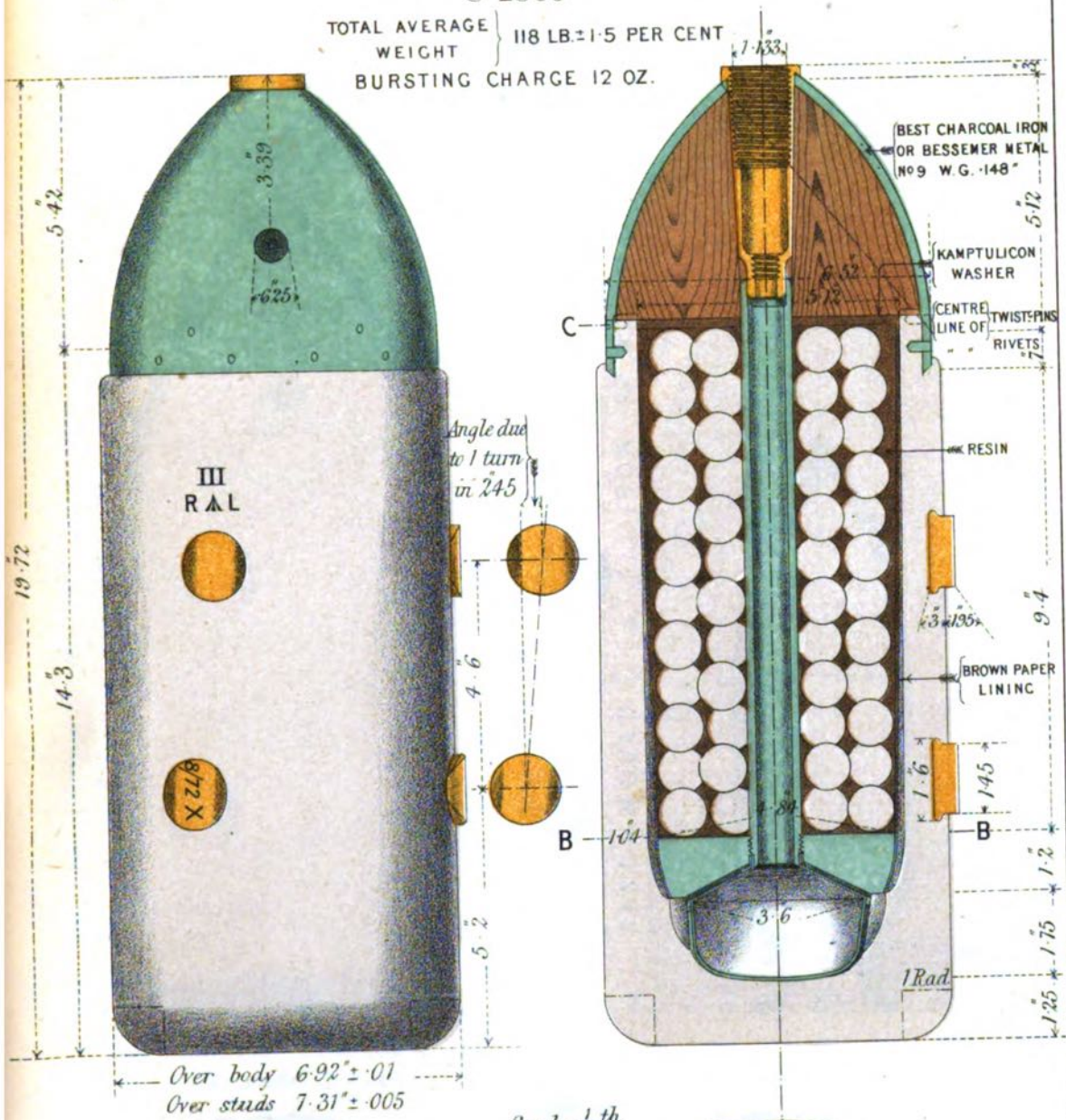









# SHOT RIFLED MUZZLE LOADING PALLISER.

## 7 INCH

## VI

## § 2222

WEIGHT  $113\frac{3}{8}$  LB  $\pm 1.5$  PER CENT  
CAPACITY FOR  
BURSTING CHARGE }  $1\frac{1}{8}$  LB.  
IF REQUIRED

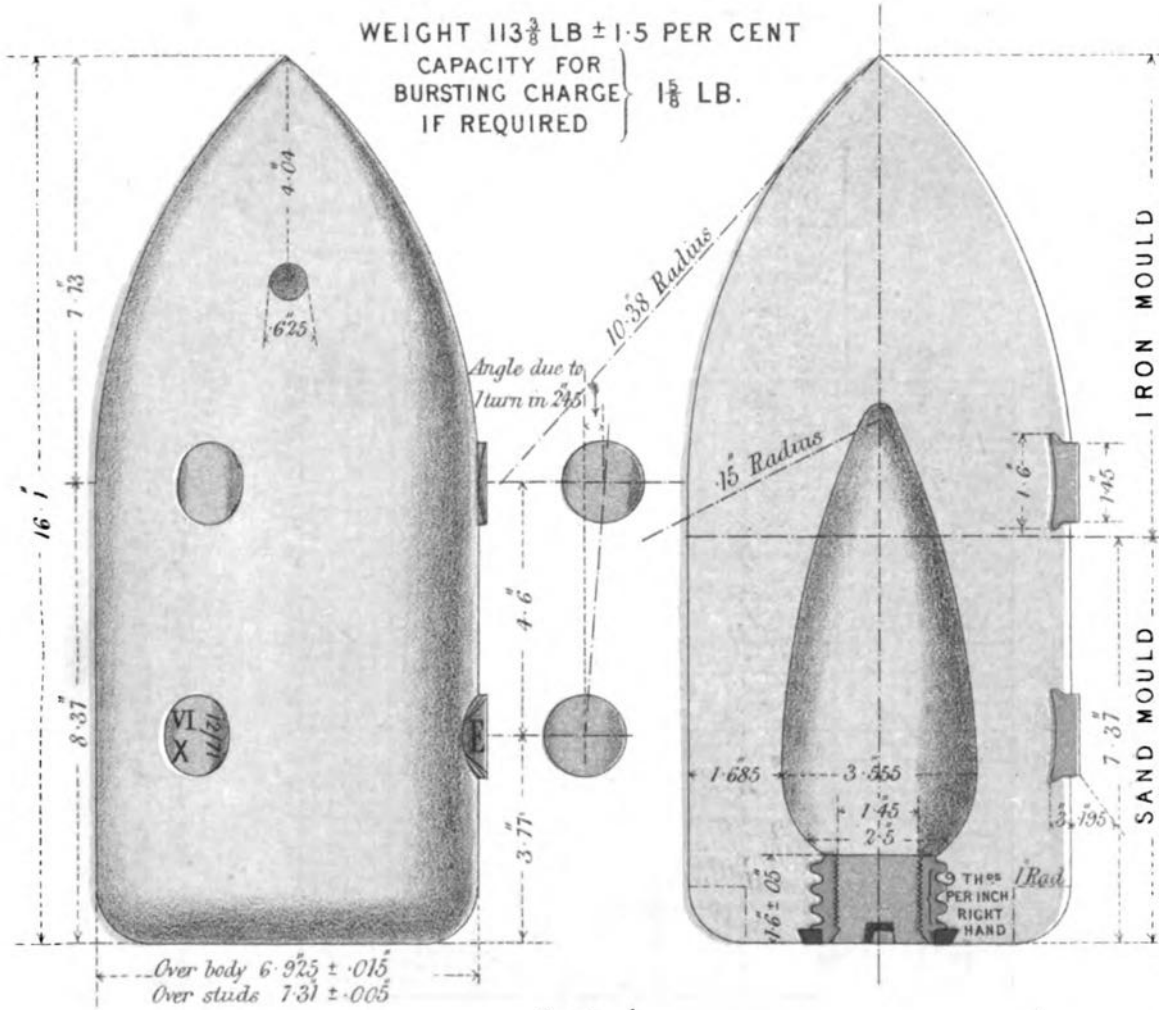

Scale  $\frac{1}{4}$

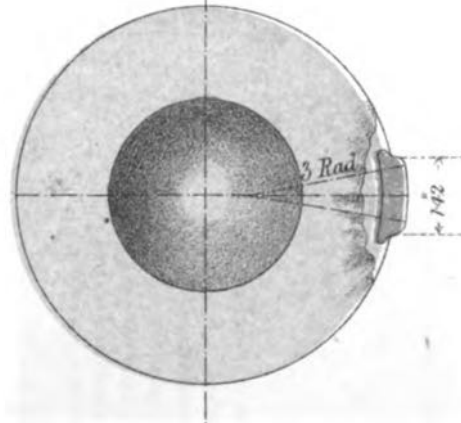



**PROOF OF AMMUNITION**

RECORD OF 20 SHOTS FROM  $\frac{1}{2}$  GAUGE Work of the 23<sup>d</sup>.

**No. 8. Diagram**

**Lab. TARGET.**

**DATA**

Rifle No. 3 B description of Snider-Breech Loading Enfield Rifle

Powder 70 Grains R.F.G. Lot 1237

Bullets 573 Clay Plug

Lubrication Wax

Cartridge Boxer Am. No. VI.

Fired from Fixed Rest

Hits 20

Missed 0

Mean Absolute Deviation 12 Inches

Number of Shots 21 to 40

Range in Yards 500

Elevation 1°45'

Point Aimed at O



Direction of Range NNE

Wind { Direction of S.W.

Strength 4 to 11

Character Gusty

Thermometer 47

Barometer 29.464

Degree of Humidity 93

ROYAL LABORATORY WOOLWICH.

23 DEC. 1884.

*Showing Deviation of each Shot*

No of Shot	Horizontal Measurement	Vertical Measurement	Absolute Deviation from Point of Mean Impact
1	1	1	1.41
2	2	1	2.24
3	1	2	2.24
4	1	10	10.05
5	1	6	6.08
6	0	5	5.00
7	0	6	6.00
8	1	3	3.61
9	0	6	6.00
10	0	6	6.00
11	0	11	11.00
12	1	10	14.03
13	2	0	2.00
14	1	1	1.41
15	2	1	2.24
16	3	2	3.61
17	2	1	2.24
18	0	10	10.00
19	1	0	1.00
20	0	3	3.00
21	0	3	3.00
22	1	4	5.00
23	1	4	5.00
24	1	4	5.00
25	1	4	5.00
26	1	4	5.00
27	1	4	5.00
28	1	4	5.00
29	1	4	5.00
30	1	4	5.00
31	1	4	5.00
32	1	4	5.00
33	1	4	5.00
34	1	4	5.00
35	1	4	5.00
36	1	4	5.00
37	1	4	5.00
38	1	4	5.00
39	1	4	5.00
40	1	4	5.00
41	1	4	5.00
42	1	4	5.00
43	1	4	5.00
44	1	4	5.00
45	1	4	5.00
46	1	4	5.00
47	1	4	5.00
48	1	4	5.00
49	1	4	5.00
50	1	4	5.00
51	1	4	5.00
52	1	4	5.00
53	1	4	5.00
54	1	4	5.00
55	1	4	5.00
56	1	4	5.00
57	1	4	5.00
58	1	4	5.00
59	1	4	5.00
60	1	4	5.00
61	1	4	5.00
62	1	4	5.00
63	1	4	5.00
64	1	4	5.00
65	1	4	5.00
66	1	4	5.00
67	1	4	5.00
68	1	4	5.00
69	1	4	5.00
70	1	4	5.00
71	1	4	5.00
72	1	4	5.00
73	1	4	5.00
74	1	4	5.00
75	1	4	5.00
76	1	4	5.00
77	1	4	5.00
78	1	4	5.00
79	1	4	5.00
80	1	4	5.00
81	1	4	5.00
82	1	4	5.00
83	1	4	5.00
84	1	4	5.00
85	1	4	5.00
86	1	4	5.00
87	1	4	5.00
88	1	4	5.00
89	1	4	5.00
90	1	4	5.00
91	1	4	5.00
92	1	4	5.00
93	1	4	5.00
94	1	4	5.00
95	1	4	5.00
96	1	4	5.00
97	1	4	5.00
98	1	4	5.00
99	1	4	5.00
100	1	4	5.00

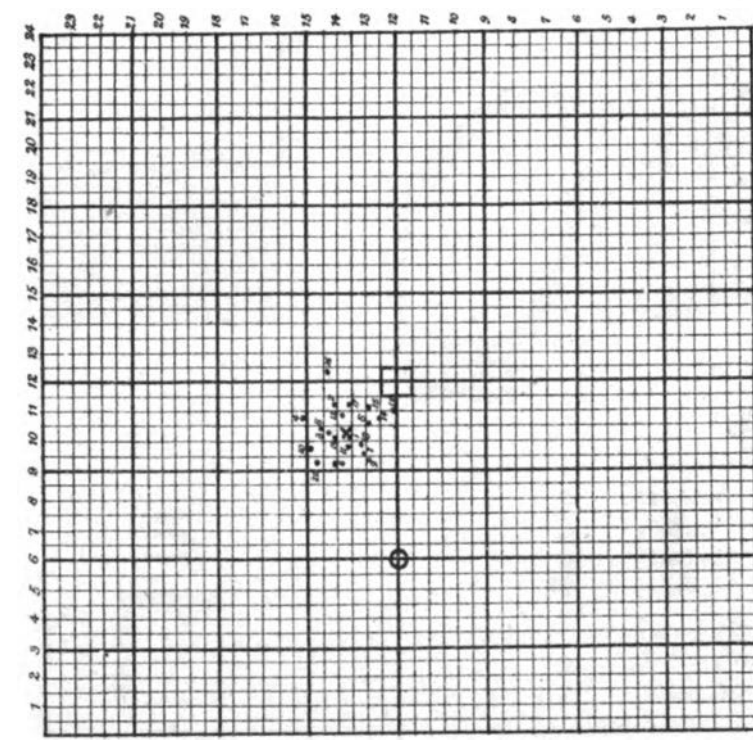

F.D. Knight, Lt. Col. 28th Buff. 57, Covent Garden, London.



**FUZE PERCUSSION R.L  
MARK II.**

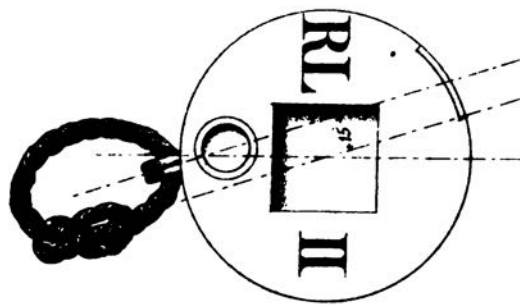
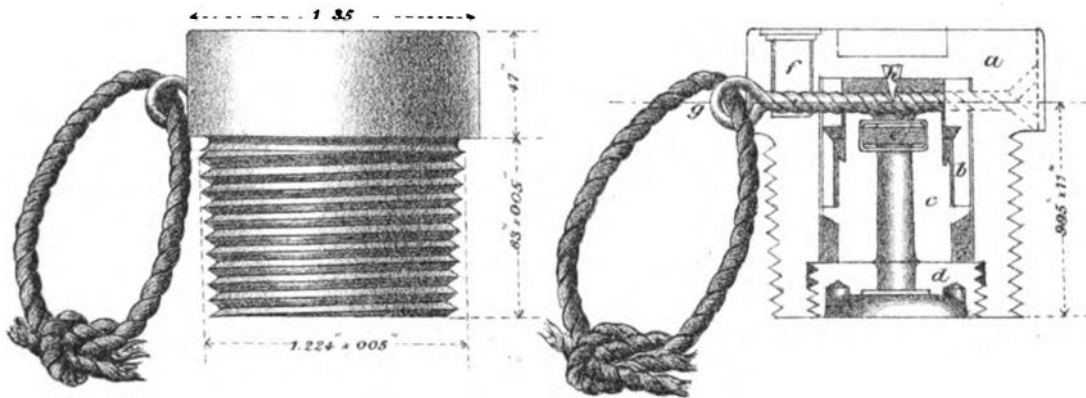

- a* ..... *Body*
- b* ..... *Guard*
- c* ..... *Pellet*
- d* ..... *Bottom*
- e* ..... *Cap*
- f* ..... *Lead Plug*
- g* ..... *Safety Pin*
- h* ..... *Steel Needle*













*MILITARY BOOKS, published by Authority—continued.*

**REPORT ON VARIOUS EXPERIMENTS**

Carried out under the Direction of the Ordnance Select Committee relative to  
**THE PENETRATION OF IRON ARMOUR PLATES BY  
STEEL SHOT.**

By **CAPTAIN W. H. NOBLE, M.A.**, Royal Artillery, Associate Member  
Ordnance Select Committee.

To which is added a Memorandum on  
**THE PENETRATION OF IRON-CLAD SHIPS BY STEEL  
AND OTHER PROJECTILES.**

Foolscap folio, with Plans. Price 2s.

**ANNUAL REPORT on the Instruction carried on at the  
SCHOOL OF MUSKETRY AT HYTHE,**

And of the Progress of Musketry Instruction in the Army, during the Year  
ending **31st March 1873.**

Price 2s.

**REPORTS of the YEARS ENDING MARCH 31, 1862, 1863,  
1864, 1865, 1866, 1867, 1868, 1869, 1870, 1871, and 1872.**

Price 2s.

**REPORTS of the SCHOOL OF MUSKETRY at HYTHE for  
the Years ending 1859, 1860, and 1861.**

Royal Svo. Price 1s. each.

**A HANDBOOK of the MANUFACTURE and PROOF of  
GUNPOWDER, as carried on at the Royal Gunpowder  
Factory, Waltham Abbey.**

By **Captain F. M. SMITH**, Royal Artillery, Assistant Superintendent.  
Printed by Order of the Secretary of State for War.

Royal Svo., cloth, with 26 Plates. Price 5s.

**THE GENERAL ORDERS**

By **HIS ROYAL HIGHNESS THE FIELD MARSHAL COMMANDING-IN-CHIEF**  
AND

**THE ARMY CIRCULARS**

Are published Monthly, and

**THE AUXILIARY AND RESERVE FORCE CIRCULARS**

Are published Quarterly. In Royal Svo.

**INDEX TO ARMY CIRCULARS, 1867 to 1873.**

Royal Svo. Price 4d.

**HISTORICAL RECORDS OF THE BRITISH ARMY, viz.:**—

Foot Regiments, 1, 3, 42 (Highlanders). Each, 12s.  
Royal Horse Guards; 17th Lancers. Each, 10s.  
Dragoon Guards, 2, 3, 4, 5, 6, 7; Dragoons, 1, 2, 3, 6, 7, 14, 15, 16; Foot, 2, 4, 5, 6, 7, 8, 9,  
10, 11, 12, 13, 15, 16, 17, 18, 19, 20, 21, 22, 23, 31, 34, 36, 39, 46, 53, 67, 71, 72, 73, 74, 86, 87,  
92 (Highlanders). Each, 8s.  
Dragoons, 9, 10, 12, 13; Foot, 14, 56, 61, 70, 88. Each, 6s.  
Cape Mounted Riflemen. 4s.

All the above Historical Records in sheets at a reduction of 6d. per copy.



*MILITARY BOOKS, published by Authority—continued.*

**ARMY EQUIPMENT.**

*Prepared at the Topographical and Statistical Department, War Office,  
MAJOR GENERAL SIR HENRY JAMES, R.E., F.R.S., &c., Director.*

**Part IV.—MILITARY TRAIN.**

Compiled by LIEUT. H. M. HOZIER, 2nd Life Guards, F.C.S., F.G.S.,  
Topographical Staff. Royal 8vo., cloth boards. Price 2s. 6d.

**Part V.—INFANTRY.**

Compiled by CAPTAIN MARTIN PETRIE, Topographical Staff.  
Royal 8vo., cloth boards. Price 5s., with Plates.

**Part VI.—COMMISSARIAT.**

Compiled by LIEUT. H. M. HOZIER, 2nd Life Guards, F.C.S., F.G.S.,  
Topographical Staff. Royal 8vo., cloth boards. Price 1s. 6d.

**Part VII.—HOSPITAL SERVICE.**

Compiled by CAPTAIN MARTIN PETRIE, Topographical Staff. Price 5s., with Plates.

**SAPPERS' MANUAL: Compiled for the Use of Engineer Volunteer Corps.** By Major W. A. FRANKLAND, R.E. Profusely Illustrated. Demy 16mo., leather, with clasp. Price 2s.

**TRANSPORT OF SICK AND WOUNDED TROOPS: A Treatise on.** By Surgeon General T. LONGMORE, C.B., Honorary Surgeon to Her Majesty; Professor of Military Surgery in the Army Medical School; Corresponding Member of the Imperial Society of Surgery of Paris, &c., &c., &c. Illustrated by nearly 200 Woodcuts. Royal 8vo., cloth boards. Price 5s.

**PRICED VOCABULARY of all Stores used in Her Majesty's Service,** and provided by the Control Department, Clothing excepted. War Office, Pall Mall, 1st November 1871. Crown 16mo. Price 4s.

**NOTES ON AMMUNITION.—(Second Edition.)—Corrected up to July 1873.** By Major BARLOW, R.A. Royal 8vo., 112 pp., with Plates, in paper covers, 2s., or in cloth boards, 3s.

**AMMUNITION: A Descriptive Treatise on the different Projectiles, Charges, Fuzes, Rockets, &c., at present in use for Land and Sea Service, and on other War Stores manufactured in the Royal Laboratory.** Ammunition for Rifled Ordnance. By Capt. CHARLES ORDE BROWNE, Royal Artillery, Captain Instructor, Royal Laboratory, Woolwich. The right of Translation reserved. (Entered at Stationers' Hall.) Printed by Order of the Secretary of State for War. September 1870. Royal 8vo. **Part II.—continued.** Price 2s. 6d.

**RIFLED ORDNANCE: A Text Book of the Construction and Manufacture of, in the British Service.** By Capt. FRANC. S. STONEY, Royal Artillery, Assistant Superintendent Royal Gun Factories, and Lieut. CHARLES JONES, Royal Artillery, Instructor Royal Gun Factories. Printed by Order of the Secretary of State for War. Corrected up to November 1872. Royal 8vo., with numerous Plates, in paper cover, price 3s. 6d., or cloth boards, 4s. 6d.

**SIEGE OF SEBASTOPOL: Journals of Proceedings connected with.** In 4 vols, 4to., price 4l. 4s., including Maps and Plans. Or in separate volumes:—Engineer Operations, Sir H. JONES, 1l. 6s. Engineer Operations, Major ELPHINSTONE (with Maps), 2l. 10s. Artillery Operations, Sir R. DACRES, 10s. Other Maps and Plans, 20s.

**EXPEDITION TO ABYSSINIA: Record of.** Compiled, by order of the Secretary of State for War, by Lieut.-Col. TREVENEN J. HOLLAND, C.B., Bombay Staff Corps, and Captain HENRY HOZIER, 3rd Dragoon Guards. In 2 vols, and case of Maps, cloth, 4l. 4s.; half morocco, 5l. 5s.

**SANITARY STATE OF THE ARMY IN INDIA: Report of the Commissioners appointed to inquire into.** With Abstract of Evidence, and of Reports received from Indian Military Stations. Royal 8vo., 608 pp., with Maps, &c. Price 6s.

**IRELAND. Hand Book of Railway Distances, compiled by direction of the Secretary of State for War from the Official Returns, &c. of the various Railway Companies.** With a Map. By WALTER WESTCOTT BROWNING, of the War Office, and revised by the Railway Clearing House, Dublin. War Office, Pall Mall, 31st October 1868. Cloth, price 6s.



## LIST OF WORKS

PREPARED AT THE

### TOPOGRAPHICAL & STATISTICAL DEPARTMENT OF THE WAR OFFICE.

**TRAINING OF TROOPS, Regulations for, for Service in the Field, and for the Conduct of Peace Manœuvres.** Translated from the German, by Captain E. BARING, R.A. Royal Svo., 84 pp., with Plans. Price 2s.

**ELEMENTARY TACTICS of the Prussian Infantry.** Translated from the German, by Captain E. BARING, R.A. Authorised Edition. Royal Svo., 60 pp., with Plans. 2s.

**RULES for the CONDUCT of the WAR GAME.** Compiled by Captain E. BARING, R.A. The Box of Men, &c., can be had for 6l. 6s., and 15 Maps, mounted and coloured, for 6l. Royal Svo., with Plans. Price 2s.

**MILITARY REPORTS: Addressed to the French War Minister** by Colonel BARON STOFFEL, French Military Attaché in Prussia. 1866-1870. Translated by Lieut.-Col. HOME, C.B., R.E. Royal Svo. Price 8s.

**REFORMS IN THE FRENCH ARMY. Part I.—The Law of Recruiting.** Translated by Lieut.-Col. HOME, C.B., R.E. Royal Svo., 104 pp., stiff paper cover. Price 1s. 6d.

— **PART II.—GENERAL ORGANIZATION.** Translated by Major C. B. Brackenbury, R.A. Price 2s.

**THE FRANCO-GERMAN WAR, 1870-71. Authorised Translation.** First Part:—History of the War to the Downfall of the Empire. Translated from the German Official Account by Capt. F. C. H. CLARKE, R.A.

First Section:—The Events in July.

Royal Svo., stiff paper cover, with Plan. Price 3s.

Second Section:—Events to the Eve of the Battles of Wörth and Spicheren.

Royal Svo., stiff paper cover, with Three Plans. Price 4s.

Third Section:—The Battles of Wörth and Spicheren.

Royal Svo., stiff paper cover, with Two Plans and Three Sketches. Price 5s.

Fourth Section:—Advance of the Third Army to the Moselle, &c.

With one Plan and Seven Sketches. Price 4s.

Fifth Section:—In the Press.

**CAMPAIGN OF 1866 IN GERMANY.** Compiled by the Department of Military History of the Prussian Staff. Translated into English by Colonel VON WRIGHT, Chief of the Staff VIII. Prussian Corps, and Capt. HENRY M. HOZIER, Assistant Controller. Price 1l. 1s., in one vol. Royal Svo., cloth boards, with a Portfolio of Plans.

**THE ARMED STRENGTH of RUSSIA.** Authorised Translation from the German. In Royal Svo., 218 pp., with Plans. Price 7s.

**THE ARMED STRENGTH OF AUSTRIA.** By Capt. W. S. Cook, 22nd Regiment. Royal Svo. Part I. 180 pp., paper covers. Price 10s. 6d.

— **PART II.**—261 pp., paper covers. Price 11s. 6d.

**A PRÉCIS OF MODERN TACTICS.** Compiled by Lieut.-Col. Robert Home, C.B., R.E. In Royal Svo., 244 pp., with 26 Plans. Cloth boards. Price 8s. 6d.

LONDON:

Printed under the Superintendence of H.M. Stationery Office,

AND SOLD BY

W. CLOWES & SONS, 13, Charing Cross; HARRISON & SONS, 59, Pall Mall;  
W. H. ALLEN & Co., 13, Waterloo Place; W. MITCHELL, 39, Charing Cross;  
LONGMAN & Co., Paternoster Row; TRÜBNER & Co., 57 & 59, Ludgate Hill;  
STANFORD, Charing Cross; and H. S. KING & Co., 65, Cornhill;

Also by GRIFFIN & Co., The Hard, Portsea;

A. & C. BLACK, Edinburgh; D. ROBERTSON, 90, St. Vincent St., Glasgow;  
ALEX. THOM, Abbey Street, and E. PONSONBY, Grafton Street, Dublin.



